

RCA Review

A technical journal published quarterly by RCA
Research and Engineering in cooperation with
the subsidiaries and divisions of RCA.

Contents

- 3 Foreword**
W. C. Hittinger and R. W. Sonnenfeldt
- 7 The RCA "SelectaVision" VideoDisc System**
D. S. McCoy
- 14 The Evolution of the RCA "SelectaVision" VideoDisc System—A Historical Perspective**
E. O. Keizer and D. S. McCoy
- 33 Capacitive Pickup and the Buried Subcarrier Encoding System for the RCA VideoDisc**
J. K. Clemens
- 60 VideoDisc Mastering**
E. O. Keizer
- 87 Materials and Process Development for VideoDisc Replication**
R. J. Ryan
- 116 The Conductive VideoDisc**
L. P. Fox
- 136 Coatings for VideoDisc**
D. L. Ross
- 162 Optical Techniques Developed for the RCA VideoDisc**
I. Gorog
- 186 VideoDisc Testing Philosophy and Techniques**
W. J. Gordon
- 198 The VideoDisc Player**
R. N. Rhodes
- 222 Patents**
- 224 Authors**

RCA Corporation

E. H. Griffiths President and Chief Executive Officer

Editorial Advisory Board

Chairman, J. J. Tietjen RCA Laboratories

N. L. Gordon RCA Laboratories

G. C. Hennessy RCA Laboratories

G. B. Herzog RCA Laboratories

E. O. Johnson RCA Research Laboratories, Inc.

C. H. Lane Picture Tube Division

D. S. McCoy Consumer Electronics

W. Merz Laboratories RCA, Ltd.

K. H. Powers RCA Laboratories

L. A. Shottliff International Licensing

T. O. Stanley, RCA Laboratories

J. J. Tietjen RCA Laboratories

W. M. Webster RCA Laboratories

Secretary, Charles C. Foster RCA Laboratories

Editor **Ralph F. Ciafone**

Associate Editors

D. R. Higgs Missile and Surface Radar Division

W. A. Howard National Broadcasting Company

C. Hoyt Consumer Electronics

D. A. Lundgren RCA Americom, Inc.

J. Schoen Solid-State Division

J. C. Phillips RCA Research and Engineering

M. G. Pietz Government and Commercial Systems

W. S. Sepich Commercial Communications Systems Division

J. E. Steoger RCA Service Company

© RCA Corporation 1978. All rights reserved, except that express permission is hereby granted for the use in computer-based and other information-service systems of titles and abstracts of papers published in RCA Review.

Foreword

This issue of the *RCA Review* covers important aspects of ongoing RCA "SelectaVision" VideoDisc developments carried on over several years. It contains review articles which, when taken together, give an overview of RCA VideoDisc system development to date. In time, more detailed papers will be available and only then will it be possible to record individual contributions fully, which regrettably is not possible here. Also, the reader should be aware that while the term "SelectaVision" at present is used by RCA in connection with both video tape products and video disc development, the papers in this issue are concerned solely with the video disc.

Video disc development was a natural undertaking for a company that had pioneered and achieved leading positions in radio, television, the electronic phonograph, sound motion pictures, and also in the technology of micro dimensions. The last was vital in packing up to two hours of high-quality video information on a 12-inch disc with signal elements smaller than the wavelength of light. This physical information density is about 100 times as high as for magnetic discs for computer applications and about ten times greater than for video magnetic tape. A major challenge was to achieve it in a product acceptable to consumers.

Apart from advancing the art of information storage and retrieval, RCA's goal was to create a consumer instrument—rugged, simple to operate, and convenient to service—that would deliver pictures and sound to receivers of any make or age, comparing favorably with over-the-air reception. It was also required that discs should play like new after use and years of storage—in Louisiana summers, Alaska winters, or Great Plains dust.

RCA's early research on capacitance playback systems predates the announcement and demonstration of pressure pickup systems and optical video disc products (also developed for home video playback). However, most of RCA's developments occurred after analyzing these other approaches and concluding that capacitance technology could achieve a most favorable balance of features, cost, and performance for video discs and players.

As work progressed, a new set of targets emerged: to extend play time from one to two hours per disc, to achieve "instant search" and "repeat play" features, to make disc mastering and replication more compatible with audio manufacturing environments, and to protect discs against consumer handling and mishandling in the home environment. These practical goals required yet another round of research and technological advances—inventions made to order and frequently delivered on very short schedules indeed.

With video information elements necessarily in the submicrometer range, a major challenge was to develop video discs and players without submicroscopic tolerances in assembly or delicate service adjustments, and to reduce disc defects to a minimum as well as to maintain good performance in the presence of irreducible defect counts. The word "irreducible" may seem dramatic until it is understood that some aberrations occupying a few square micrometers are unavoidable on 12-inch discs

with a recorded area of 48 billion square micrometers, and that such defects cause annoying picture disturbances in poorly designed systems. Major efforts were successful in achieving the goal of acceptable manufacturing tolerances with performance broadly immune to "normal" defect levels.

The developmental process also included further monitoring of competitive announcements and investigation by RCA of optical systems and pressure pickup technology. Before the final decisions were made, RCA scientists succeeded in recording RCA 450 RPM video discs by optical, electron beam, and direct electromechanical cutting methods and in playing all of these discs by capacitance, pressure pickup, or optical means. What emerged from this work was evidence that a system employing direct electromechanical cutting of masters to replicate noncoated plastic discs with capacitance playback would best meet the challenging goals RCA had set for itself in manufacturing, performance and reliability margins.

During 1977, over 200,000 VideoDiscs were produced in pilot operations. On the basis of tens of thousands of test hours—with dozens of computerized testers and several series of human-factor tests with prototype players, we developed a thorough understanding of the technology as well as product-performance reliability margins. Over the years, product economics were an ever moving target. RCA developers had to aim at constantly lower capital outlays and production costs, while each year the dollar would buy less. These economic challenges were so severe that they could be surmounted only by still other advances in technology, resulting in major product simplifications.

The proposed RCA system includes a player, shown in Fig. 1, with all controls



Fig. 1—RCA VideoDisc Player.

and disc loading through a slot in the front. Its service requirements should compare favorably with those of a TV receiver. The disc is plastic and is enclosed in a "caddy" package slightly over 12 inches square from which it is extracted only inside the enclosed player. Disc playing time is two hours, and performance compares handsomely with the best possible over-the-air reception.

In toto, these developments have led to a product design that meets the criteria of economic viability and consumer acceptability. These achievements were essential to pave the way for a constructive approach to programming, distribution, and those other questions on which RCA has not yet reached a conclusion.

RCA's VideoDisc technology has now matured sufficiently to publish these initial papers. It is an exhilarating experience and a great honor to be associated with the dedicated researchers, inventors, designers, assemblers, and testers at Princeton and Indianapolis, led by D. S. McCoy and T. Callahan, who have developed this high-performance VideoDisc system. This issue of the *RCA Review* was made possible by their skill, imagination, and hard work and should be a great source of satisfaction to them. A vote of thanks is also due to Dr. William Webster, whose unflinching support has been most important to the success of this effort.

W. C. Hittinger

Executive Vice President, Research and Engineering

R. W. Sonnenfeldt

Staff Vice President, SelectaVision VideoDisc

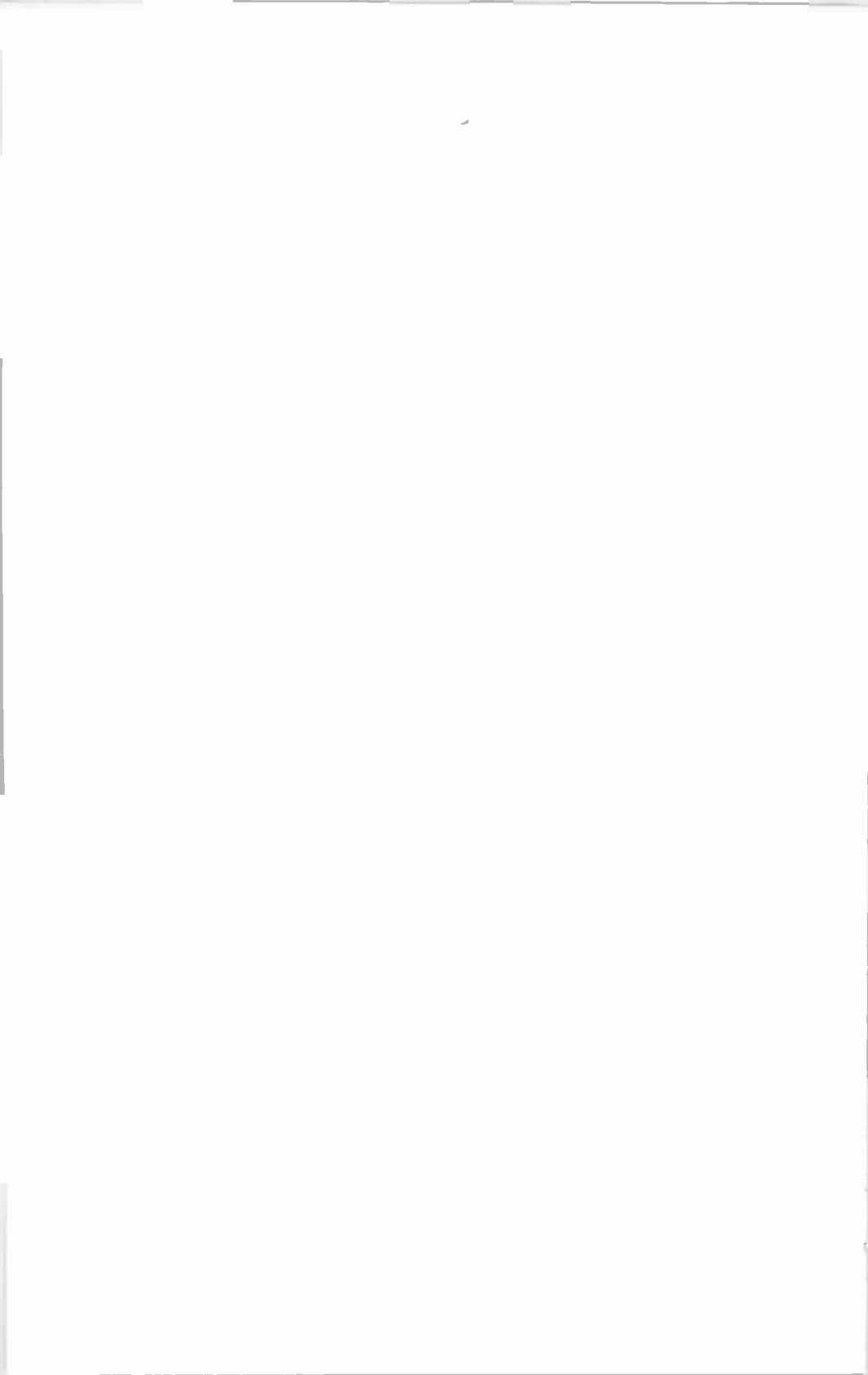

The RCA "SelectaVision" VideoDisc System

D. S. McCoy

RCA Laboratories, Princeton, N.J. 08540

Abstract—The basic information-storage and signal-retrieval principles employed in the RCA "SelectaVision" VideoDisc System are described. The steps involved in producing finished discs, starting from the recording of masters from original program sources, are outlined; and the functions performed by the player in reproducing the program for presentation on conventional color television receivers are described. This brief summary description of the RCA VideoDisc System provides a "broadbrush" understanding of the overall system and refers the reader to appropriate companion articles in this special issue of *RCA Review* for more detailed information on specific aspects of the system.

Introduction

The papers that follow in this issue of *RCA Review* dedicated to the RCA "SelectaVision" VideoDisc describe the technical principles involved in all aspects of recording programs of video and stereophonic sound on master discs, replication of that information on pressed vinyl discs, and recovery of the original program by the VideoDisc player for reproduction through a conventional color or black-and-white television receiver. To tie these individual papers together and provide a framework for understanding the complete VideoDisc system, this article briefly describes the basic principles of signal recovery from the disc, the steps involved in making discs in quantity, and the functions performed by the player in recovering the signal for playback through the television receiver. At appropriate points in this brief summary, references will be given to guide the reader to the proper article in this special issue of *RCA Review* for an expanded discussion of the subject.

No system of such complexity is, of course, ever conceived from the start in its mature and final form. The research and technical development that led to the RCA VideoDisc system in its present form has taken place over more than a decade. During that time, major progress has been made in the techniques used for signal encoding, master recording, and the method of achieving surface conductivity of the disc. A great deal of very fine technical work has gone into the development of materials and techniques, some of which have been abandoned as others were developed with performance or economic advantages. In the articles that follow, some of these earlier techniques and processes, even though they are not used in the present system, are alluded to or may be described in detail in order to show the advantages of the present approach. A separate article by Keizer and McCoy traces the evolution of these changes in the system, explaining the reasons for the major system choices that were made.

System Principles

Before the steps in making a VideoDisc can be described, it is necessary to describe the form in which the information is stored on the disc and the capacitance pickup principle by which it is recovered. The RCA VideoDisc is capable of storing two hours of recorded picture and stereo sound on the two sides of a rigid 12 inch disc. A spiral groove, "V" shaped in cross-section, guides the diamond pickup stylus as the disc rotates at 450 rpm. Fig. 1 depicts the grooved surface of the disc and the tip of the stylus tracking in the groove. Information representing the luminance, chroma, and audio signals is contained in transverse slots of varying width and periodicity impressed into the bottom of the groove. The tip

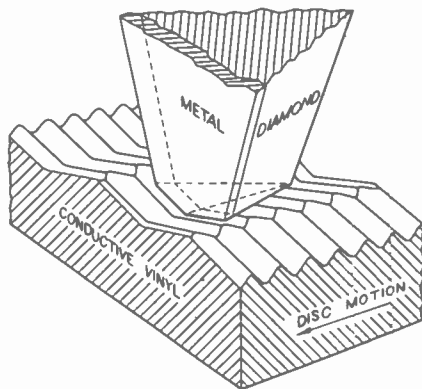

Fig. 1—Perspective drawing of stylus with metal electrode and segment of disc.

of a thin metallic electrode on the flat trailing edge of the stylus serves as a capacitance probe for the recovery of the signal. The conductive surface of the disc serves as the other plate of the "capacitor." As the disc rotates and the stylus tracks along the groove, the capacitance variations due to the passing of the signal-bearing indentations under the stylus tip are sensed by a technique described in the article by J. K. Clemens entitled "Capacitance Pickup and the Buried Subcarrier Encoding System for the VideoDisc." Table 1 lists a number of significant parameters of the system.

Disc Mastering and Replication

The various steps involved in making a master recording and producing discs in quantity from it are depicted in Fig. 2. These steps can be briefly described as follows:

1. Mastering

Programs are received for mastering in the form of film (35 or 16 mm) or on any professional form of magnetic tape. Video, chroma, and audio signals are encoded as described in the Clemens article noted above. Also, at this point, groove identification number codes are inserted in the vertical blanking interval. The resulting fully encoded signal is then supplied to the cutter head of the electromechanical recorder. A diamond cutting stylus driven by a piezoelectric element cuts the "V" shaped groove in a smooth flat copper substrate and simultaneously cuts the signal elements in the bottom of the groove. The recording is made at real time, which requires the cutter head to respond at frequencies as high as 9.3 MHz, the upper limit of the upper sideband of the video carrier. Details of this electromechanical mastering technique, along with

Table 1—Summary of the Pertinent Parameters of the RCA VideoDisc System

Record diameter	12 inches
Record thickness	0.07 inch (at center and outside rim)
Rotation rate	450 revolutions per minute
Center-hole diameter	1.5 inches
Recorded band	2.85 inches wide (5.72 to 2.85 inches radius)
Play time	120 minutes (60 minutes each side)
Recorder FM signal	4.3 to 6.3 MHz
Luminance bandwidth	3.0 MHz
Chrominance bandwidth	0.5 MHz
Video signal-to-noise ratio	>46 dB (CCIR Weighted)
Audio carriers	716 and 905 kHz
Audio bandwidth	20 kHz
Audio-signal frequency deviation	±50 kHz
Audio-signal-to-noise ratio	60 dB (approx.)

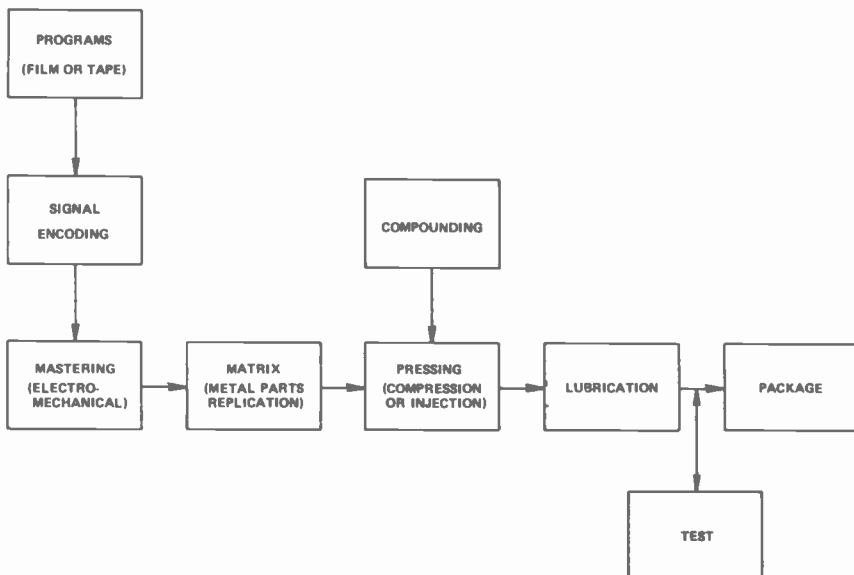

Fig. 2—Disc manufacturing steps.

descriptions of electron-beam and optical-recording methods, which were developed as earlier alternatives, are presented in the article "VideoDisc Mastering" by E. O. Keizer.

2. Matrix (Metal Parts Replication)

This original copper master has the surface relief pattern that will appear on the final disc. To permit large quantities of discs to be pressed, however, a number of metal stampers, which are negative replicas of the original copper master, must be generated by a "fan-out" procedure similar to that used in the production of audio phonograph records. The copper master, after suitable passivation of the copper surface, is given a thin metal coating. This coating is then built up by electroplating and separated from the original, giving a "metal master" that is a negative replica of the original. This process is repeated to form a number of positive copies (variously called molds or mothers). Each mold can then be replicated to produce a number of negative replicas or stampers that are used to press discs. This process and details on the "fan-out" ratios that can be achieved without degradation are presented in "Material and Process Development for VideoDisc Replication" by R. J. Ryan.

3. Compounding

The base material of the disc is a polyvinyl chloride (PVC) resin. Conductivity is achieved by loading of this resin with carbon of extremely small and uniform particle size. This carbon, along with additives to improve compound stability and flow characteristics, is mixed uniformly into the PVC base resin and the resulting compound is formed into pellets for easy delivery to the presses. The compounding process and special considerations necessitated by carbon loading are described in "The Conductive VideoDisc" by L. P. Fox.

4. Pressing

Stampers for both sides of the disc are precisely centered and mounted securely to two mold halves that are then bolted to the two jaws of the press. In compression molding, a "puck" of compound derived from melted pellets is accurately metered out and placed between the stampers, which then close with great force to form the disc. After flash at the outer edge is trimmed away, the disc is placed on a spindle. Conductive VideoDiscs may also be pressed by injection molding, in which case the jaws are closed and clamped as the molten compound is injected at high pressure into the cavity between the stampers. These processes are described in more detail in the article "Material and Process Development for VideoDisc Replication" by R. J. Ryan.

5. Lubrication

It has been found that a thin coat of lubricant (approximately 200 Å thick) is extremely beneficial in prolonging the life of the stylus and disc. This lubricant is applied by a relatively simple spray process to both sides of the disc simultaneously, following which it is respindled. Considerations of the lubricant composition, its long-term stability, and its compatibility with the disc and stylus materials are covered in "Coatings for VideoDiscs" by D. L. Ross.

Prior to the development of a satisfactory conductive disc compound, the surface conductivity necessary for capacitive pickup was obtained by coating discs pressed from conventional nonconducting PVC with thin coatings of metal, styrene, and oil as a continuous process in an automatic coating machine. These coating processes and the necessary monitoring of coating thicknesses and composition were successfully accomplished only with the aid of some very sophisticated technology, which is also reported in the Ross article.

Testing

Because of the extremely high density of information on the surface of any 12-inch disc capable of storing two hours of recorded video and stereo sound program, the VideoDisc is a demanding product to produce. Damaging flaws capable of obliterating seconds of program or causing the stylus to mistrack can be introduced at any step of the disc manufacturing process. Because of their small size, these flaws are difficult to detect. Test equipment and techniques had to be developed to meet this challenge. Several sophisticated optical inspection techniques, which have proved to be invaluable as quality control tools, were developed as an outgrowth of earlier optical recording research. These are described in "Optical Techniques" by I. Gorog. Further, discs must be tested for their ability to withstand repeated plays without degradation and to withstand environmental extremes likely to be encountered in the home and during transportation to dealers. The RCA VideoDisc system has probably been subjected to a more extensive pre-introduction test program than any previous RCA product. Details of the test program for RCA VideoDiscs are given in "Testing Philosophy and Techniques" by W. J. Gordon.

Packaging

The grooves of the RCA VideoDisc are extremely shallow, in the order of one-half micrometer deep. Minimum recorded signal wavelengths are of the same order in size. Surface contamination from dust, saliva spots or oil from fingerprints may cause poor tracking or loss of signal. The grooves can also be damaged by scratches or abrasion if the disc is not carefully handled. An extensive series of tests in the laboratory and in private homes led to the conclusion that the disc required more protection from dust and damage during handling than a conventional audio record, which has a much lower density of information and much deeper grooves. We believe, in fact, that any type of video disc that employs a stylus in contact with the disc will require such protection. To ensure that the disc is shielded from surface contamination and handling damage, a protective package, or disc "caddy", was designed which the disc never leaves except during play, when it is automatically extracted by a simple mechanism in the slot-loading player.

The Player

After the recorded signals are recovered from the disc by the capacitance sensing technique described earlier, the player must perform the following functions:

- (1) Decode the buried subcarrier signal to recover luminance and chroma signals.
- (2) Detect the two sound signals from the baseband sound carriers.
- (3) Compensate for picture drop-outs due to loss of carrier caused by random defects on the surface of the disc by substitution of a delayed signal from the previous horizontal scanning line.
- (4) Correct time-base errors due to warp and eccentricity to prevent picture jitter on receivers with slow horizontal sync circuits.
- (5) Reconstitute an NTSC signal suitable for reception at the antenna terminals of the television receiver.

These functions and other design and performance considerations of the player and caddy are discussed in "The VideoDisc Player" by R. N. Rhodes.

Acknowledgments

The RCA VideoDisc system encompasses a very large body of technological development representing the efforts of a great many scientists, engineers and technicians. The number of papers covering specific aspects of the VideoDisc technology that could be written is very large. It would have been difficult to choose a subset of these papers that gave a coherent picture of the present RCA VideoDisc system. For this reason, the group of technical team leaders and managers who constitute the authors of the papers in this issue were asked to cover broad segments of the system which, in combination, would furnish a complete description. It is unavoidable that the authors will be presenting analyses or results that are primarily the work of others. For this reason, the reader will find somewhat more lengthy acknowledgments than usual at the end of these articles.

In future issues of the RCA Review and other appropriate technical journals, technical articles covering specific elements of the VideoDisc technology will be published by those individuals directly responsible for the work.

Finally, I would like to express my personal thanks to all those at RCA Laboratories in Princeton and in the "SelectaVision" development groups in Indianapolis who have worked with such commendable dedication on this VideoDisc system over the many years required for its gestation.

The Evolution of the RCA "SelectaVision" VideoDisc System—A Historical Perspective

E. O. Keizer and D. S. McCoy

RCA Laboratories, Princeton, N.J. 08540

Abstract—The original motivation for the conception of the RCA "SelectaVision" VideoDisc System is presented, along with the guidelines for final product characteristics that influenced the technical paths chosen. The evolution of the system in form and capability is traced. Problems encountered along the way and the techniques derived for their solution are presented. Finally, a recent series of system changes instituted to enhance product reliability and durability and reduce manufacturing cost are described.

Introduction

In the early 1960's, when it became apparent that color television was successfully launched, the questions arose in RCA, and no doubt in many other electronics companies, "What comes after color TV? What will be the next major consumer electronics system? What do we do for an encore?" There seemed to be a place for some type of system that would provide prerecorded programs of video and sound to the TV receiver, permitting the user to satisfy his own special interests from a wide variety of available programs and to choose the viewing time at his convenience.

While magnetic tape appeared to have good promise as a home recording medium for off-the-air television programs, it did not appear to be a good candidate for prerecorded video programs. If programs were to be produced as prerecorded tapes, the cost of the tape itself in a length sufficient for a feature movie seemed excessive for a mass consumer

product. Further, programs could only be replicated on tape by some form of serial recording technique requiring a considerable time for the transfer of each program, and therefore requiring a large number of expensive duplicating stations if programs were to be produced in quantity.

The answer seemed to lie in increasing the amount of information on a phonograph record to an extent that would permit the storage of video programs of reasonable length. Material cost of a vinyl record is low, and the entire program is molded into its surface in 30 seconds or less. A serious effort was initiated at RCA Laboratories in the mid-1960's to "invent" a video disc system that would retain the same advantages as the audio record and that would provide a new mechanism for home entertainment and education.

It may be instructive to review the original perceptions of the product guidelines for the RCA VideoDisc and see how they influenced its present form.

From the beginning, the following three attributes were considered essential for a successful video disc system:

- (1) *Low cost* of both player and disc to permit the establishment of a mass market for the new pre-recorded video system.
- (2) *Picture quality* comparable to the best off-the-air reception, with sound quality (including stereo) better than that provided by commercial television broadcasts.
- (3) *Long playing time* to accommodate a variety of entertainment and self-education programs, including feature-length movies, with the smallest possible number of discs.

The requirement for low player cost argued in favor of a *grooved* disc in which the groove walls provided the guiding force to keep a stylus riding over signal elements in the groove without the complexity and cost of a servo-controlled tracking system. Early experiments confirmed that a stylus could be made to track a smooth shallow groove in a disc rotating at the speeds (up to 600 rpm) that might be required to recover signals at a rate compatible with the reproduction of full-bandwidth video. Higher rotational speeds were considered, but it was felt that to track at such speeds would require uneconomically tight tolerances on disc warp and centering.

The other two requirements, high picture quality and long playing time, forced the conclusion that signal elements of extremely short spatial wavelength, probably in the submicron range, would have to be recorded and reproduced. It had already been recognized in the 1950's that physical detail as small as $0.1 \mu\text{m}$ could be faithfully replicated into the surface of a vinyl disc by embossing or molding. Therefore, if a way could be found to record such extremely small signal elements on a

master, they probably could be replicated into the surface of an inexpensive disc by processes similar to those used in making audio records. It was not clear that such a master could be made. The first question appeared to be, though, "If such a disc existed, what method could be used to detect signal elements of submicron size?"

Optical pickup techniques were considered, but ruled out for reasons of cost and complexity. This left two contenders consistent with the grooved disc concept that had been chosen for player simplicity. A pressure-sensitive pickup, employing a stylus of extremely small tip dimensions driving a piezoelectric transducer element to convert pressure variations to electrical signals, was considered as early as 1964 at RCA Laboratories; but was judged to have several disadvantages. First, a stylus tip sharp enough to detect submicron signal elements and still maintain any reasonable stylus life would be difficult to fabricate. Second, it was believed that this type of pickup would be difficult and expensive to build because of the number of small, dimensionally precise pieces that must be assembled and bonded together, including a diamond or sapphire tip, the piezoelectric block with metallic electrodes on top and bottom surfaces, and the two signal-conducting leads. Because of the wide frequency response necessary to reproduce video signals, all elements of this pickup would have to be extremely small. It seemed, therefore, that achieving reproducible response from unit to unit would be difficult unless tight dimensional tolerances were maintained during manufacture. Despite these anticipated disadvantages, some development effort on this type of pickup was expended at RCA Laboratories; and at a later time, in 1972, a contract was let to an outside company to develop pressure pickups for further evaluation.

The second contender, a capacitance pickup, appeared to have a great deal to recommend it. The basic principal proposed was to sense the electrical capacitance between a conductive surface on the disc and a thin metallic electrode carried by a stylus tracking in a shallow groove. The value of the capacitance would be modulated by the depth of signal slots molded into the bottom of the groove. Because the stylus tip would span a number of signal elements it would ride smoothly along the groove with no vertical or transverse motion required. The ability of the stylus to detect short wavelength signals would be determined by the thickness of the electrode and its spacing from the signal elements. One obvious concern was how to fabricate such a stylus. An early concept was to evaporate the thin metallic electrode onto a flat wafer of sapphire and then bond a second wafer to it, thus forming a "sandwich" with the electrode in the middle. Subsequent shaping operations would then create an elliptical tip bisected by the electrode. If the surface of the disc were coated with a thin layer of metal and then by a thin, tough insu-

lating layer, the recorded signals represented by slots in the bottom of the groove could be detected by the variation in electrical capacitance between the conductive surface of the disc and the very tip of the electrode embedded in the stylus as it passed over the slots. This type of pickup had the advantage that the response to a given spatial wavelength was dependent only upon the thickness of the electrode in the direction along the groove and not upon the dimensions of the tip. For this reason it figured to have a response that stayed constant as the tip dimensions changed due to wear.

Later, when experimental tips were built, it became apparent that the sandwich structure was difficult to fabricate and to shape with the electrode properly centered. It was found, however, that a quite acceptable capacitance pickup could be made simply by depositing the electrode on the flat trailing edge of a "sled" shaped tip. This deposition of the electrode could be done on a large wafer of sapphire prior to dicing and shaping, resulting in a relatively simple fabrication method. Experiments on scaled models of this type of stylus, and subsequently with an actual stylus drawn across a plastic grating covered with metal and insulating coats to simulate the surface of a recorded disc, confirmed that quite usable peak-to-peak variations in capacitance could be detected by this method.

Having decided upon capacitance pickup as the approach to pursue, the principal task became to determine some practical means of recording the master discs. All of the then-known techniques for recording of information at extremely high storage density were compared. The principal contenders appeared to be:

- Magnetic recording
- Electromechanical cutting
- Optical recording in photoresist
- Electron beam recording in electron-beam-sensitive materials.

While it appeared that it might be possible to replicate programs on magnetic discs by some form of contact process, the density of information that could be stored on a single disc of reasonable size by this technique was too low, so that many discs would have been required for programs of normal length.

Electromechanical cutting by a heated diamond stylus in lacquer, similar to the technique used in the recording of audio records seemed a strong possibility. But the audio cutter had a frequency response of about 20,000 Hz, while the recording of a high quality video signal would require a response in the megahertz range. The recording response could be extended only by a drastic size reduction of the cutter and tip, which seemed improbable at that time, or by recording at a rate many times slower than the real-time rate. At such slow rates the problem of main-

taining a sufficiently constant rotation of the recording turntable to prevent time-base errors in the recording seemed formidable indeed. Nevertheless, because this approach was easier to implement in a rudimentary form for experimentation, it was pursued. The first recordings at RCA Laboratories that produced recognizable pictures from a disc were made by this technique.

Optical recordings by means of laser exposure of photoresist was considered because it had the advantage that a sufficiently high density of energy could be obtained in a finely focused spot to permit the exposure of available photoresists at real time rates. On the debit side, though, it seemed unlikely that an effective exposed element size smaller than $1.0\ \mu\text{m}$ could be obtained because of diffraction and geometric effects, thus prohibiting recorded signal wavelengths smaller than about $2\ \mu\text{m}$. Further, when focused to a spot smaller than $1.0\ \mu\text{m}$, the depth of focus was of the same order. This required either extreme flatness of the recording substrate or some means of automatic focus adjustment, and probably both. This shallow depth of focus also was expected to make it difficult to maintain the spot in good focus at the bottom and up the sides of the relatively deep groove that was then considered to be necessary to guide the pickup stylus. Subsequently, quite a few years later, these difficulties were overcome and it proved to be possible to make optical recordings in the grooved format of the RCA VideoDisc with the necessary submicron recorded wavelengths as described in a companion paper in this issue.¹

At the time, in the mid-1960's, in consideration of all of the recording requirements for developing a VideoDisc system, electron-beam recording (EBR) seemed to be the most promising method and was the one chosen as the principal path to be followed. The advantage that carried the most weight was the ability to record submicron signal wavelengths of good definition. Usable depth of focus was obtainable. Further, EBR offered great versatility in the recorded patterns, even permitting amplitude modulated signals to be recorded by either width or depth modulation. Subsequently, the signal-to-noise ratio advantages offered by FM recording dictated its choice as the modulation technique, but in the early period, before the characteristics of the VideoDisc as an information "channel" were determined, AM modulation was a strong contender because it appeared to offer the possibility of longer play time for a given minimum recorded wavelength.

By the late 1960's, the basic approach of the RCA VideoDisc system had been set. It was to be a grooved disc, the same size as an audio record, coated with thin conducting and insulating coatings, played back with a capacitive pickup technique, and masters were to be made by electron-beam recording.

Electron-beam recording, however, was not without its disadvantages. It was painfully slow because of limited beam intensity and material sensitivity. As described in the article on mastering,¹ recording was done initially by scanning a circular beam of electrons transversely across the groove. It was not possible to get sufficient energy to permit real-time recording in a circular beam small enough to record the small wavelengths required. The earliest electron-beam recordings at RCA Laboratories, in fact, were made at a rate 200 times slower than real time and required some very ingenious solutions to achieve the necessary constancy of rotation speed.

The electron-beam recorder for 12-inch discs was still not completed and no satisfactory master recordings had, in fact, been made by June 1970 when the public announcement and demonstration of a video disc was made by TELDEC, a joint venture of Telefunken and Decca of England. The TELDEC (later TED) disc had been developed in a small laboratory in Berlin, originally set up for the purpose of improvement of phonograph recording techniques. The TELDEC engineering group had succeeded in recording 5 minutes of video and sound on an 8-inch thin flexible disc by means of electromechanical cutting at a rate 25 times slower than real time. Signals were reproduced by means of a pressure pickup using a sled-shaped diamond stylus that transmitted vibrations from the recorded vertical, or "hill-and-dale", undulations to a piezo-electric element.

At RCA it was recognized that the TELDEC approach had many limitations, notably the very short playing time, as well as a limited bandwidth and an encoding system that gave fairly "soft" pictures. However, it was a startling achievement and stimulated redoubled efforts on the RCA approach. Because the electron-beam recorder was not yet operational, several test recordings were made by electromechanical cutting at RCA Laboratories in about August 1970 to investigate signal encoding schemes and to make further checks on the capacitance signal-pickup method. Fig. 1 is a photograph of the TV picture reproduced from one of the first experimental discs with a few minutes of video recorded by electromechanical cutting in lacquer. It had only 1 MHz of video bandwidth on an FM carrier of 2 MHz. These earliest discs were coated with evaporated aluminum covered by a glow-discharge-deposited polystyrene dielectric layer and by a thin, spun-on coat of silicone oil to reduce stylus wear.

By April 1971 the electron beam recorder was operating and the first masters were recorded with it. Fig. 2 shows the capability as of July 1971. Dropouts due to defects in the master and pressings were extremely numerous because clean processing techniques had not yet been established.



Fig. 1—Photograph of picture reproduced on a TV screen while playing a disc made from an early (August 1970) electromechanical recording.

Evolution of Recording Technique

Following the first electron-beam recordings in 1971 came a very gradual series of improvements in mastering capability. It was obvious that this technique would not be practical for commercial production until recordings could be made at a real-time rate or at least close to it. At rates much slower than real time, the yield of good recordings was low because of the difficulty of maintaining stable operation of the electron-beam recorder and the special slow-speed signal equipment for many hours and because of the possibility of some malfunction such as filament burn-out during the recording. Fig. 3 shows the progression of improvements in recording speed versus time. The figures in parentheses indicate the ratio of the recording rate to real time. Up to about April 1974, the increases in recording rates were accomplished by modifications to the electron optics of the scanning electron microscope column used on the electron-beam recorder and the formulation at RCA Laboratories of the "Mark II" electron beam resist with improved sensitivity to electron beam exposure. The biggest step toward real time came with the transition from a scanned circular spot to a sheet beam from a line source and a completely redesigned electron-optical column, which was completed early in 1975.

The other principal task in the improvement of electron-beam recording was that of reducing defects in the master to the lowest possible level. These defects resulted from inhomogeneities in the electron-beam



Fig. 2—Photograph of picture reproduced on a TV screen while playing a disc made from an early (July 1971) electron-beam recording.

resist or, more frequently, from dust particles that became attached to the surface of the master in the recording or processing steps. The major improvement here came when the mastering facility was installed in Indianapolis, with all operations involved in the preparation, recording, and development of masters performed in class 100 clean rooms. These precautions resulted in a major reduction in defects on the masters and a consequent improvement in yield of good masters.

During this entire period since 1970, a smaller but persistent effort was continued on electromechanical (EM) recording. The inducement for continuing this work, even when it became apparent that satisfactory real-time electron-beam recording had been achieved, was the recognition that EM recording could be done without elaborate and expensive clean rooms, so that subsequent mastering facilities necessary to meet the anticipated demand for VideoDiscs could be established with considerably smaller capital investment.

Fig. 4 shows the recording speed progression for EM recordings. Here the problem was a different one from that encountered with the electron-beam recordings. To achieve the greater frequency response necessary for each increase in recording speed, the mass (and, therefore, the physical size) of the cutter heads had to be reduced. The most dramatic improvement came with the discovery in March 1974 that vastly improved recordings could be made in copper rather than the lacquer that was used for audio recordings and had been used in EM recording of

ELECTRON BEAM RECORDING CHRONOLOGY

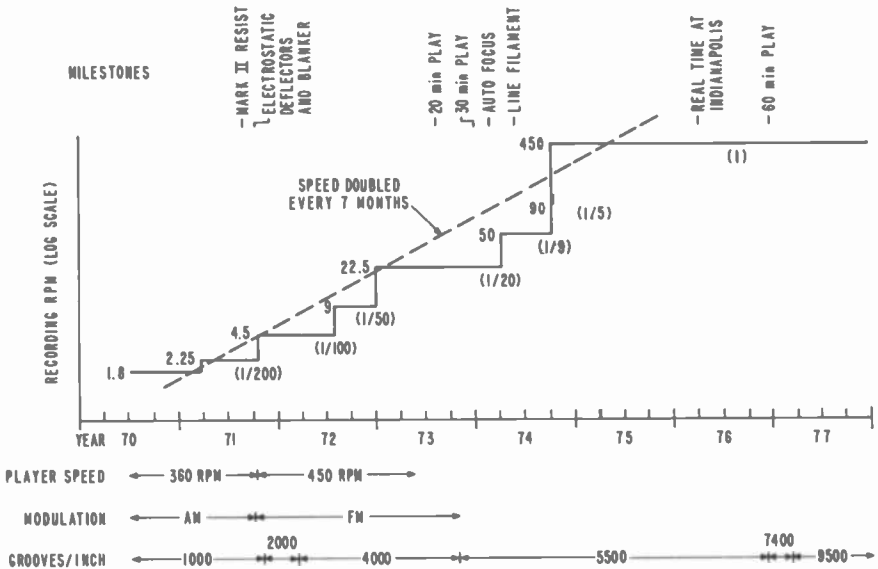

Fig. 3—Chart showing the chronological improvement in electron-beam mastering speed along with mastering and system steps related to the speed increases.

VideoDisc masters up to then. Recording in lacquer required that the diamond cutting tip be heated by a coil of fine wire around its shank. In copper, it was no longer necessary to heat the tip so the shank of the diamond could be shortened, reducing its mass and extending the frequency response.

Evaluation of EM recordings in copper showed two other valuable advantages. First, the background noise level of signals from discs made from these masters was lower than for electron-beam recordings by 5 or 6 dB, because the electromechanically cut surface was smoother than the surface of an electron-beam resist that had suffered some microscopic roughening due to erosion in the development process. Second, defects in the master were lower by at least an order of magnitude than in electron-beam masters processed under the cleanest conditions. It was this combination of advantages, lower initial investment and improved yield of quality recordings, that prompted the decision to switch over to EM mastering as the preferred technique when it became possible late in 1976 to make recordings at real time by this method.

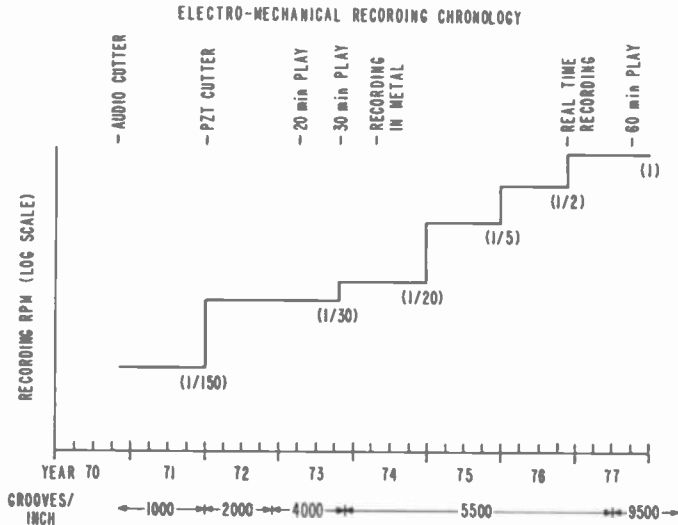

Fig. 4—Chart showing the chronological improvement in electromechanical mastering speed, along with mastering and system steps related to the speed increases.

Pressing Methods

Audio phonograph records are normally pressed by compression molding, a technique in which a pre-formed “puck” of hot compound is inserted, either manually or by an automatic arm between stampers on the upper and lower mold halves of the press. As the mold halves are closed, the compound in the puck is squeezed outward between the stampers which are heated by steam. After the jaws are completely closed, the stampers are cooled by cycling cold water through channels in the mold halves. Injection molding is another type of process, sometimes used for pressing 7-inch audio records. In injection molding, molten compound is forced under high pressure between the stampers mounted on the closed and clamped mold halves.

In 1973, when consideration was first given to a production molding process for VideoDisc, the choice was made to use injection molding. This choice was made despite the fact that injection molding had not previously been used for pressing 12-inch records because of the difficulty of obtaining good “fill” at the outer radii of the discs. Engineering studies commissioned with a vendor of injection molding equipment showed that it was possible to get good edge fill when pressing VideoDiscs because their shallower grooves produced less “drag” on the material as it was forced between the stamper.

Injection molding was attractive for several reasons. Since the mold halves were not cycled in temperature as in compression molding, it was easier to assure a tight seal between the stamper and the mold half at

the outer edge and center hole. This prevented small particles of compound from getting behind the stamper to cause dents in the record. Second because the temperature of the compound as it was injected between the stampers was higher than the temperature of the puck used in compression molding, there was less microscopic abrasion of the inner grooves of the stamper on each cycle, with the result that more discs could be produced from a given pair of stampers before performance at the inner grooves was degraded. The first injection press was installed at the RCA Rockville Road plant in Indianapolis in July 1975. Two more of improved design were added early in 1976, and a fourth press to replace the first one which had proved inadequate in clamp pressure was installed early in 1977.

Later in this article the reasons for switching to the use of conductive compound to eliminate the need for metal and styrene coatings are discussed. One consequence of this decision, however, is that because the carbon-loaded compound necessary for the conductive disc is much stiffer, it is more difficult to mold by an injection process. For this reason, compression molding, which works well with the conductive compound, has again become the chosen production method. Development efforts now underway are aimed at improving this process to reclaim as many of the advantages of injection molding as possible. At the same time, study is being devoted to the formulation of conductive compounds of improved flow characteristics that will be compatible with the injection molding process.

Coating Processes

As a consequence of the original choice of a capacitance type pickup, it was necessary that the vinyl disc be coated first with a thin layer of metal to provide conductivity, then by a thin durable layer of dielectric, and finally by a coating of lubricant to prolong the life of the stylus and disc. In the initial experiments to demonstrate the feasibility of capacitance pickup, evaporated aluminum was used as the metallic coating, as was mentioned earlier. It proved to be too grainy, and evaporated gold was found to produce much better pictures. Gold, however, would have been too expensive for coating discs in high volume. Experiments in 1972 showed that copper, deposited either by evaporation or sputtering, provided smooth films with excellent adhesion to vinyl, and copper became the standard conductive coating material for the next several years. It was found very early that glow-discharge deposited polystyrene provided a layer of good dielectric properties and was adequately durable even at coating thicknesses of 200 Å or less. The lubrication was provided by a thin coating, again about 200 Å thick, of a silicone oil deposited

initially by a spin-coating process and later by vacuum evaporation. In these early experiments, coatings were deposited layer by layer, one side at a time in individual bell-jar deposition chambers. It was obvious that this type of coating process was unsuitable for the production of discs in large quantities, and the initial concept was developed for a production coater, about which more is said later.

When copper was chosen as the conductive layer material, it was recognized that it was a chemically active metal subject to a variety of corrosion reactions. It was hoped, however, that the over coating layers of a tightly adherent and highly cross-linked organic polymer layer of polystyrene, followed by a thin layer of oil, would shield the copper from harmful corrosive agents. This proved not to be the case. It was found that fingerprint acids from some individuals were particularly corrosive and that the styrene and oil layers were too thin and porous to provide the necessary protection. Furthermore, atmospheric pollutants such as H_2S , SO_2 , and NO_2 in sufficiently higher concentration, particularly in the presence of high humidity, could cause corrosion of the copper layer, resulting in delamination of the layers above the corroded areas and total loss of signal at these points on playback.

Early in 1975 a search began, therefore, for a corrosion-resistant metal for the conductive layer. Inconel, an alloy of nickel, chromium, and iron was found to be such a metal. However, sputtered layers of Inconel were found to have high internal stress and adhered poorly to both vinyl and styrene. Adhesion problems were solved by sputtering an extremely thin layer (about 50 Å) of copper onto the vinyl prior to the Inconel to provide an adherent "buffer layer". Another 50 Å layer of copper was sputtered atop the Inconel to provide good adhesion with the styrene. This "tri-metal" sandwich proved much more highly resistant to corrosion. Later, it was found that proper control of the oxygen content at the surface of the Inconel layer permitted good adhesion of styrene and the upper layer of copper was eliminated. The resulting "bimetal" sandwich proved even more highly resistant to corrosion and passed all corrosion tests.

It was clear from these early difficulties that application of the coatings would be the most demanding operation in the production of a demanding product. In order to be able to coat discs economically in high volume, it would be necessary to employ some type of highly automated process to minimize labor costs. Large individual batch processes for sequential deposition of metal, styrene, and oil were considered but rejected. Not only would more handling of discs be required to transfer them from one coating process to the next, but they would be exposed to the atmosphere between successive coatings with the result that adhesion of the styrene to the metal coating might be affected by variations in humidity or the presence of atmospheric pollutants. For all of these

reasons the best approach seemed to be a fully automated, continuous in-line coater to apply metal, styrene, and oil in a sequence of vacuum processes without exposure to the atmosphere between steps. Preliminary engineering studies with an outside firm resulted in the conclusion that such an "Autocoater" was feasible and its production was commissioned in June 1974.

Refinement of the various deposition processes and debugging the internal disc conveyor mechanisms of this Autocoater proved to be difficult. The magnitude of this task can be appreciated from the explanation of the Autocoater and its function in the article "Coatings for VideoDiscs," by D. L. Ross in this issue of RCA Review. It was not until December 1976, after an exhaustive series of tests at the vendor's site, that the Autocoater was accepted and crated for shipment to Indianapolis.

Dust and Environmental Problems

Early in 1976, then, with the injection presses and the Autocoater installed and operational, it became possible to press and coat discs in substantial quantities for the first time. During the remainder of 1976, in fact, some 240,000 experimental discs were pressed and 120,000 were coated. Up to this time so few discs were available that they were treated with great care, were used only by engineering personnel, and seldom left the laboratory. With more discs and players available from a short engineering pilot run, a private "field test" was run early in 1976. Twenty-five players each accompanied by seven hours of programs were placed in the homes of non-engineering personnel for several weeks and then rotated to other homes. This proved to be an instructive but chastening experience. Problems sufficient to cause substantial concern showed up. Breakage or chipping of the sapphire styli happened far too frequently. Many of the discs showed evidence of damage in the form of "scoring", where it appeared that the stylus had dug in for periods as long as several rotations of the disc, cutting through the coating layers into the underlying vinyl and resulting in the total loss of signal on subsequent plays. In the test homes there was a much higher incidence of mistracking in which the stylus skipped forward or backward. Of these, the backward skip is the more disturbing to the viewer because the stylus appears to be "stuck" at one point in the program for several seconds until it finally clears. Reinspection of these discs following the tests showed that a majority of them exhibited scratches, greasy fingerprints and spots identified as residue of saliva, beer, coke, and jelly. Microscopic examination also showed a considerably higher density of adherent dust particles on the surface than normally encountered under laboratory test conditions.

The frequency and severity of problems encountered in these private field tests prompted an intensive reassessment of the product and its vulnerabilities. Laboratory investigations initiated to gain understanding of the field-test problems finally yielded an explanation for the mysterious "video virus" that had been seen to appear for a period of time and then inexplicably disappear, sometimes for periods of months.

The onset of such a "virus episode" was characterized by erratic signal pickup or even loss of signal for several seconds, frequent mistracking with locked and skipped grooves, stylus breakage and chipping, and visible evidence of damage to the disc. Because this condition tended to occur more frequently during late summer when humidity was high, discs had been tested after long exposure in humidity chambers at close to 100% relative humidity. But it was not possible to duplicate the video virus effects in these humidity tests. Similarly, the effects of dust had been investigated earlier. Room dust was found to produce little or no virus, even when heavily deposited. The explanation finally uncovered was that dust was, in fact, the problem; but only when accompanied by high humidity. When a dusty disc was subjected to up to 80% relative humidity, virus and locked grooves became severe on first play, but cleared up quickly on successive plays. At higher humidities, especially when accompanied by elevated temperatures, virus and locked grooves became permanent features of the disc. Water soluble components present in most types of dust particles stained the disc in the vicinity of the particle and attached it firmly to the surface of the disc (see Fig. 5). Other tests confirmed that dust adhered equally well to discs with no coatings at all. A variety of alternative lubricants were investigated, but none appeared to offer a first-order solution to the problem of dust adherence in the presence of high humidity.

Because the private field test had demonstrated convincingly that the discs were vulnerable to dust problems under conditions that might be encountered in the normal home environment and were vulnerable to scratching unless handled very carefully, the conclusion was reached in September 1976 that the video disc must be protected by a rigid sleeve or cassette, which subsequently came to be known as a "caddy" package. The concept was that the disc would never leave its caddy except during play when it would be automatically extracted by a simple mechanism in a slot-loading player. Subsequent tests with engineering samples proved the caddy was capable of protecting the disc even against prolonged exposures to wind-driven dust in laboratory dust chambers.

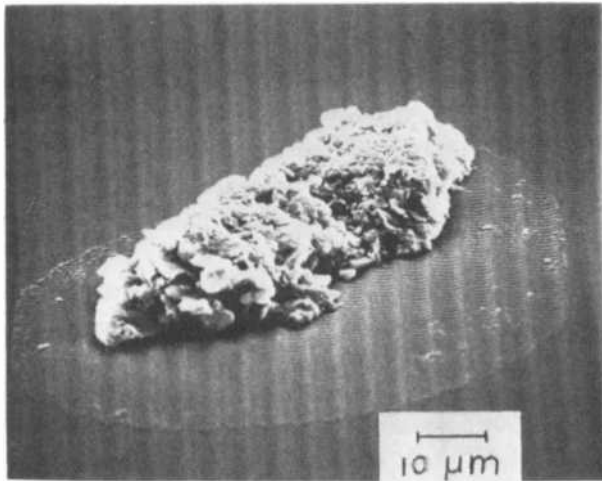

Fig. 5.—Scanning electron microscope photo of a particle that has become firmly attached to a disc surface due to the combination of high humidity and high temperature.

Subsequent Product Decisions

During the period in late 1976 following the recognition of the need for the protective caddy package, the entire system concept was re-examined with particular emphasis on reduction of manufacturing costs. It has also already been mentioned that electromechanical recording had been found to offer both performance and cost advantages over electron beam recording, and the decision was made to switch over to electromechanical recording completely. Two technical advances that occurred at this time appeared to have economic advantages which forced them to be seriously considered.

In November 1976, experimental recordings were made at RCA Laboratories that doubled the playing time to 60 minutes per side with no deterioration in picture performance. This was done by increasing the groove density from 5555/inch to 9541/inch. Studies showed that 90% or more of all feature-length movies could be accommodated on one disc with a 2-hour total playing time. The economic advantage of this is obvious. If movies constitute the largest segment of the program sales in both dollars and units, as they are expected to, then a given number of programs can be produced with half the discs and caddies.

The only significant drawback to doubling the play time per disc appeared to be that narrowing the groove required the use of a smaller tip on the stylus, rendering it more vulnerable to breakage and wear. This problem was overcome by a decision to switch from the sapphire styli, which had been the mainstay during all of the previous development,

and go to diamond styli which were considerably more resistant to breakage. Techniques were developed for lapping the tip of the diamond stylus to a narrow "keel" shape (see Fig. 6) which maintained approximately the same width as the tip was slowly eroded during play. This tip-shaping technique prolongs the useful life of the stylus to several hundred hours.

Coincidentally, it was found that the use of diamond has another advantage over sapphire. Certain types of debris, including flakes of the Inconel coating, apparently are capable of bonding themselves chemically or physically to the shoe of a sapphire stylus forming sharp edges that are responsible for the occasional "scoring" of the disc grooves mentioned earlier. Diamond styli, with their nonreactive oxide surface layer, do not exhibit this phenomenon. The use of diamond styli has virtually eliminated scoring on any type of disc surface.

The second major technical advance, which occurred in January 1977, was the pressing of the first satisfactory discs from conductive compound. Attempts to press discs of conductive material were made as early, in fact, as 1972 as an alternative to the complex coating processes. These early attempts had been unsuccessful because of materials limitations, producing "noisy" discs as a consequence of surface roughness. These experiments were resumed when a source of finely divided carbon

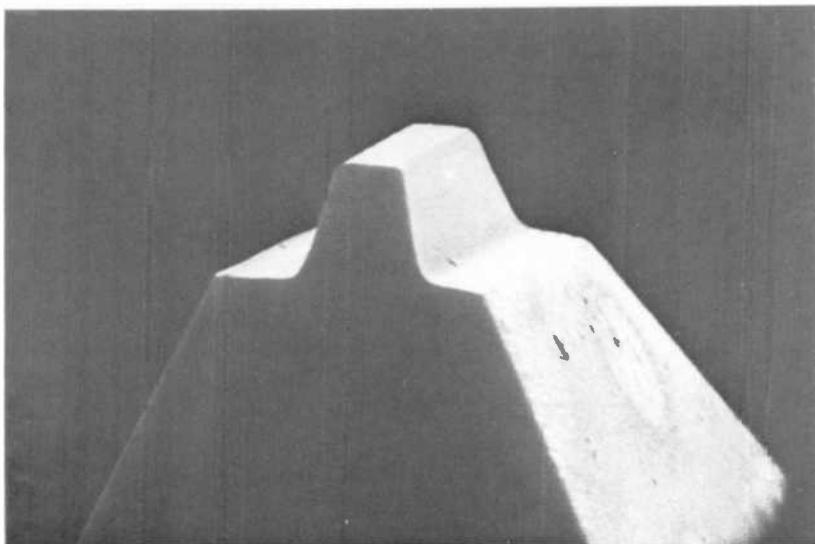

Fig. 6—Scanning electron microscope photograph of the tip of a stylus that has been lapped to have a "keel." The keel provides a greater volume of stylus material within the width of a groove, hence greater stylus wear life.

with uniform particle size of 300 Å or less was found. By uniformly dispersing these carbon particles in the proper proportion throughout the vinyl compound, discs of good surface quality with low resistivity at 915 MHz could be pressed. The signal-to-noise ratio recovered from these discs was within a few dB of equalling the best of the coated discs and was certainly adequate for a commercial product (see Fig. 7).

As was mentioned earlier in the discussion of pressing methods, the inclusion of the carbon tends to stiffen the compound rendering it somewhat difficult to mold by an injection process. However, it molds quite readily in a compression press, and the present conductive discs are molded in this fashion. The strong advantage of the conductive disc is the elimination of all coatings except oil, which can be applied by a variety of relatively simple and inexpensive processes. The need for the expensive Autocoater is eliminated, making it easier and less costly to scale up production capability to satisfy the build-up of production requirements as the demand for the VideoDisc expands.

Reassessment of Alternative Pickup Techniques

Toward the end of 1977 the RCA VideoDisc was reassessed relative to other systems, announced or hypothesized, that would employ grooved nonconductive discs played by pressure pickups. The assumption was made that such systems would use the same electromechanical mastering



Fig. 7—Photograph of a picture reproduced on a TV screen while playing from a one-hour-per side disc.

approach as the present RCA VideoDisc System, would have about the same density of recorded information, and would utilize some type of vinyl homopolymer or copolymer as a disc compound. Any such system would have similar requirements for disc flatness and dimensional stability as the RCA system. It follows from these assumptions that they would be equally vulnerable to the dust and scratches that are unavoidable in normal use, even with careful handling, and would therefore also require some type of protective package or caddy.

The principal advantage of the pressure pickup is that it permits discs to be made from a more conventional nonconducting compound. Although the per-disc cost of adding the carbon to make the compound conductive as required for capacitance pickup is in the order of pennies per disc, even this small cost penalty would be undesirable unless it bought some performance advantage.

In our own tests of pressure pickups it was found that under ideal conditions their performance was excellent, producing picture quality fully comparable to that of the capacitance pickup. The differences showed up in tests of playback under more adverse conditions. In the presence of dust or debris, even the relatively small amounts present when protected by the caddy, clumps of debris accumulate around the stylus and are carried along with it as it tracks along the grooves. With the capacitance pickup, this creates no problem because the dust is normally nonconducting and the signals continue to be detected by the tip of the stylus electrode. Even with masses of debris large enough to lift the stylus away from the groove, usable signals are still detected so long as the electrode is lifted no more than 500 or 600 Å. With the pressure pickup, any lifting of the stylus away from contact with the signal elements, however slight, results in a total loss of signal. Further, even if lifting does not occur, clumps of debris surrounding the stylus contact signal elements in the groove at points that may be several μm ahead of or behind the actual stylus tip. Pressure impulses are transmitted through this debris and the stylus tip to the piezoelectric sensor and appear as "ghosts" that precede or follow the video image.

Another consideration between capacitive and pressure pickups is the question of consistency of electrical response from unit to unit. The importance of this is that if a replacement pickup differs in frequency response from the original one, circuit adjustments to equalize this response would be required at the time of replacement. The capacitance pickup itself has a smooth frequency response with no electrical or mechanical resonances. The pressure pickup has a pronounced resonance at the upper end of its frequency response that is dependent upon the dimensions and material properties of the diamond stylus and the piezoelectric element. To eliminate unit-to-unit variations in resonance

frequency and electrical response that would require compensation in the player, the resonance frequency must be pushed well above the frequency band to be detected from the disc; i.e., well above 9.3 MHz. To achieve such high resonance frequencies in a pressure pickup requires precision in the dimensions of a rather small device, which may pose problems in fabrication.

It will not be possible to assess the severity of the potential problems with pressure pickups mentioned above until an adequate number of them have been subjected to the same kinds of exhaustive tests that capacitance pickups have been exposed to. If pressure pickups proved in such tests to be capable of achieving adequate stylus life without deterioration of response, if adequate consistency of response from unit to unit can be achieved economically, and if problems of susceptibility to debris are proved to be benign in normal consumer use, they could be considered a viable alternative to the capacitance pickup. In this case, it is highly likely the two types of pickup would be compatible, in the sense that conductive discs could probably be played equally well by either type of pickup.

Summary

The RCA "SelectaVision" VideoDisc system has evolved from its earliest conception to its present configuration and capability over a period spanning the better part of two decades. It offers abundant examples of the difficulties and complexities involved in bringing a new consumer electronics system requiring major elements of new technology from a laboratory curiosity to a state approaching readiness for production. During this period the consuming public has become more sophisticated and demanding. Sheer technical novelty no longer suffices to assure the success of a new product concept. To field such a product, in addition to offering a new service, it is necessary now to assure in advance that the product will meet current expectations for quality, reliability, durability, and value for the dollar. It has been shown how these considerations influenced the original systems choices that were made, and how, over a period of time, they have forced certain redefinitions of these system choices to meet the evolving requirements dictated by the marketplace.

References:

- ¹ E. O. Keizer, "VideoDisc Mastering," *RCA Review*, 39, No. 1, p. 60, March 1978 (this issue).

Capacitive Pickup and the Buried Subcarrier Encoding System for the RCA VideoDisc

J. K. Clemens

RCA Laboratories, Princeton, N.J. 08540

Abstract—A high resolution capacitive pickup and buried subcarrier signal encoding system were developed for the RCA VideoDisc. Although the pickup and the encoding system were developed to operate together as a system, each has unique advantages in its own right that would be useful in other applications. The first part of this paper gives an overview of the characteristics of the capacitive pickup, along with the characteristics of pickup styli and discs that are required to provide high quality video and audio performance from pre-recorded signals replicated by production record pressing techniques. The second part gives an overview of the recorded signal channel and the buried subcarrier encoding system, which is matched to the channel. Buried subcarrier refers to a composite video signal in which the chrominance carrier is placed at a relatively low frequency in the luminance channel in such a way that the chrominance and luminance can be easily separated. The discussion includes the relationships among the minimum wavelength, rotational velocity, groove pitch, and stylus life. The choice of these various system parameters and the signal system parameters, such as FM carrier frequencies and deviations, are presented. The advantages of the buried subcarrier encoding in conserving bandwidth and increasing playing time while meeting the constraints of the channel such as nonlinearities and noise spectrum are noted.

1. Capacitive Signal Pick-up

The capacitive pickup was developed to read signals from a plastic disc, similar to an audio disc, that contains stored video and audio information. The disc has a fine spiral groove to guide a stylus that contains a thin electrode, and the video and audio information is stored in the form

of depressions in the bottom of this groove. For the signal to be detected capacitively with a high quality, the disc itself is conducting or has a conductive layer on it. The stored information is read by measuring the capacitive variations between the electrode on the stylus and the surface of the disc. Detection of the small capacitive variations is performed by forming a resonant circuit with the stylus-disc capacitance. Pickups made in this manner can resolve signal elements significantly smaller than the wavelength of light with sufficient reliability to reproduce high quality video and audio signals.

1.1 Relation of Recorded Signal Elements and Capacitance

Let us first consider a disc made of nonconductive plastic with a thin conductive layer on it; the conductive plastic disc is considered later. It can be shown that the conductive layer can have a resistance of tens of kilohms per square. However, the layer is usually made of metal approximately 250 Å thick with a typical resistivity of 300 ohms per square. To keep the stylus electrode from shorting to the conductive layer, an insulating layer is placed on the conductive layer. This insulating layer is typically approximately 200 Å thick. The final coating is then a lubricant which is typically 50 to 200 Å thick.

Fig. 1 shows perspective and cutaway views of a stylus and disc surface with typical dimensions indicated.

The stylus body is made of either sapphire or diamond. Its only function is to track the groove and support an electrode that is coated on its trailing face. The stylus shape is usually such that it forms a triangular footprint. Many shapes are possible, and the footprint dimensions are quite variable. A typical size would be 2 μm across the groove and 5 μm along the groove. The rest of the stylus shape is determined by mechanical design. It should have strength to resist breaking and its footprint should not change greatly with wear. The electrode thickness is usually 1000–1500 Å.

The capacity of interest between the electrode and the conductive surface decreases as the distance between them increases. The degree of linearity between the distance and the capacity depends upon the electrode size, the magnitude of the distance change relative to the average distance, and upon the dielectric constants of the surrounding material including the stylus body material. It can be shown that, for a thin electrode surrounded by material of the same dielectric constant, the capacity versus distance is related by

$$C_{TOT} = \epsilon_0 \epsilon W \left(\frac{4}{\pi} \right) \ln \frac{H}{2h} \quad [1]$$

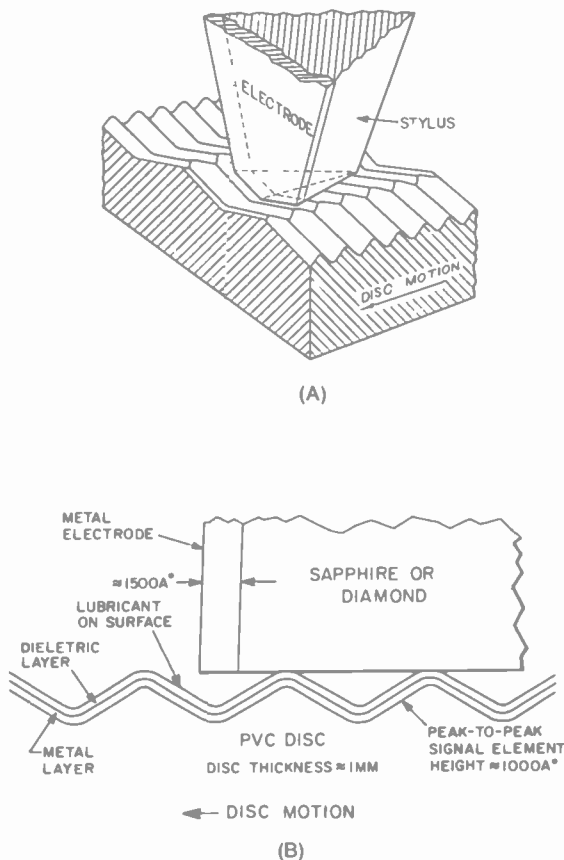

Fig. 1—Perspective and cutaway views of stylus and coated disc.

where ϵ is the dielectric constant, W is the width of the electrode (looking into the paper in Fig. 1B), h is the elevation of the electrode edge from the conducting surface, and H is the height of top edge of the electrode.

As an example, consider an elevation change from 250 Å to 1250 Å approximating 1000 Å peak-to-peak signal elements, a stylus width of 2.5 μm and a dielectric constant of 2.5. The change in capacitance would be

$$\Delta C = 1.1 \times 10^{-16} \text{ farad}$$

The change in capacitance for small changes in elevation can be written

$$\frac{dC_{TOT}}{dh} = -\epsilon_0 \epsilon W \left(\frac{4}{\pi} \right) \left(\frac{1}{h} \right). \quad [2]$$

The resolution of the pickup is also a function of the height of the electrode from the disc surface. Under the same assumptions used previously, the equivalent transfer characteristic can be calculated. For a small signal amplitude at an average elevation h from the electrode edge, the transfer characteristic can be shown to be

$$A(h, \lambda) = \frac{h_0}{h} e^{-2\pi h/\lambda} \quad [3]$$

where h_0 is an arbitrary reference height and λ is the wavelength of the recorded signal.

As can be seen from Eq. [3], if

$$\frac{h}{\lambda} \ll \frac{1}{2\pi},$$

the transfer characteristic does not vary significantly with changes in λ . However, if

$$\frac{h}{\lambda} \gtrsim \frac{1}{2\pi},$$

shorter wavelengths will be detected with smaller amplitude than equal-amplitude recorded signals of longer wavelengths. The amplitude for a given wavelength decreases and the change in amplitude as a function of wavelength increases as h is increased. However, this is a gradual change and is not abrupt when the stylus loses contact with the disc surface. Therefore, the capacitive pickup does not require absolute contact with the disc surface.

The previously derived expressions are based on a number of simplifications: a thin electrode, small signal element heights compared to the electrode elevation, and an electrode surrounded by material of uniform dielectric constant. None of these simplifications is strictly true, but all of the changes toward more realistic conditions are second order effects. The electrode thickness is actually approximately 1500 Å but is significantly smaller than the wavelength of the recorded signals. The peak-to-peak signal elements are on the order of 1000 Å, which is approximately the electrode elevation. This causes the response to be nonlinear. Also the electrode is surrounded by material of different dielectric constants. On the leading side of the electrode is a sapphire or diamond stylus with approximate dielectric constants of 9 and 4, respectively. On the trailing side of the electrode is air with a dielectric constant of 1. Under the stylus are a lubricant and an insulator, each with a dielectric constant of approximately 2.5. If the lubricant is fluid, it may also surround the parts of the electrode and disc that are of interest. The most significant of these second order effects is the presence of the stylus body.

Its high dielectric constant can concentrate the field pattern on the stylus side of the electrode. This concentration is relatively more significant as the electrode (and stylus) elevation is increased. The result is an apparent shift in the position or phase of the detected signal as the stylus is elevated. The derivation of these second order effects and their consequences will be covered in a future paper.

The disc surface can also be made conductive by pressing the disc out of a conductive plastic compound. It can be shown that if the conductive plastic has a bulk resistivity on the order of 10 ohm-centimeters at the frequency of operation (in our case 915 MHz) the disc will behave essentially as a disc with a conductive layer on it. The resistivity at lower frequencies can be higher and, in fact, can be quite high at dc. An advantage is that no extra insulating coating need be applied. There can be extra sources of noise due to poor mixing of the compound, but if the disc is made correctly, capacitive pickup from a conductive compound disc is very similar to that from the coated disc, and all the previous descriptions apply.

1.2 Detection of Capacitive Variations

A cutaway view of an arm cage, cartridge, and disc is shown in Fig. 2. The removable cartridge contains the light stylus tracking arm, the stylus, and a spring that doubles as an electrode connection. When the cartridge is placed in the arm cage, the spring makes a butt contact to the arm circuitry and the other end of the stylus arm is connected to a velocity corrector. No other electrical connections are made directly to the cartridge.

The electrical path that contains the stylus disc capacitance is from the arm circuitry through the stylus spring to the electrode, then to the disc surface, and back to the arm circuitry through the large capacitance between the disc surface and the bottom of the arm cage. Although the arm circuitry operates at 915 MHz and uses transmission line techniques,

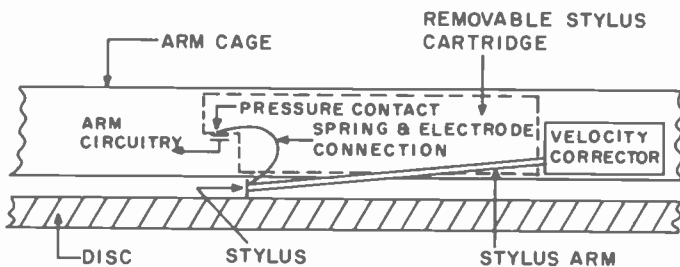

Fig. 2—Cutaway view of arm cage and stylus cartridge.

its function can be described schematically by the lumped-element circuit shown in Fig. 3.

The circuit path described above is constructed as a resonant circuit including the stylus-disc capacitance. The resonant peak of this circuit will change as the capacitance changes. This resonant circuit is shown in Fig. 3A and its response as a function of frequency is shown in Fig. 3B. This resonant circuit is excited by an oscillator with a frequency on the slope of the resonance curve. The response to the excitation is detected with a pickup loop. The magnitude of the detected response will depend upon where the oscillator frequency falls on the resonance curve. As the stylus-disc capacitance changes, the resonant frequency will change such that the detected carrier will be amplitude modulated, and the voltage obtained by peak detection of this carrier represents the stylus-disc capacity.

Let $H(\omega, \omega_r)$ represent the transfer function of the resonant circuit from the oscillator port to the carrier output port, as shown in Fig. 3B. ω_r represents the resonant frequency of an assumed single-pole resonance. The magnitude of this response can be written

$$|H(\omega, \omega_r)| = k/\sqrt{(\omega - \omega_r)^2 + \alpha^2}, \quad [4]$$

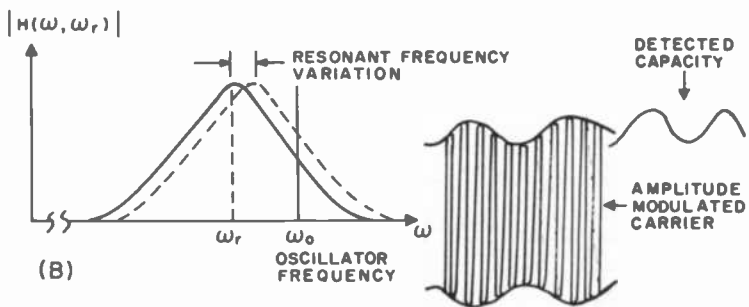
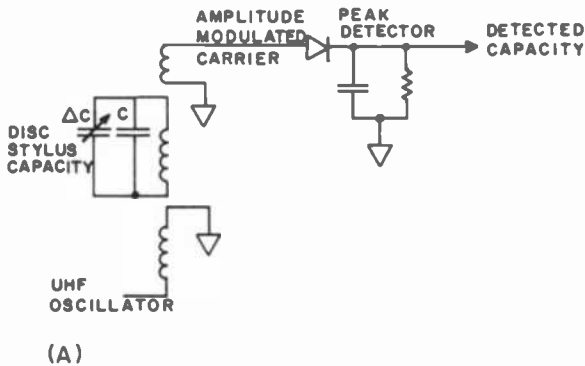

Fig. 3—Capacitance detection: (A) detection circuitry and (B) circuit signal responses.

where k and α are constants of the system and

$$\omega_r = 1/\sqrt{LC}. \quad [5]$$

The derivatives of $\ln |H|$ and $\ln \omega_r$ are

$$\frac{\Delta|H|}{|H|} = \frac{(\omega_0 - \omega_r)\Delta\omega_r}{(\omega_0 - \omega_r)^2 + \alpha^2}, \quad [6]$$

$$\frac{\Delta\omega_r}{\omega_r} = -\frac{\Delta C}{2C}, \quad [7]$$

where ω has been replaced with the oscillator frequency ω_0 . It is seen that $\Delta|H|/|H|$ has a maximum sensitivity with respect to ω_r when $\omega_0 - \omega_r = \pm\alpha$, i.e., at the 3-dB points of the transfer characteristic. If we choose the constants to operate at this point, the combination of Eqs. [6] and [7] yields the degree of amplitude modulation

$$\frac{\Delta|H|}{|H|} = -\frac{\omega_r}{4(\omega_0 - \omega_r)} \frac{\Delta C}{C} = -\left(\frac{Q}{2}\right)\left(\frac{\Delta C}{C}\right). \quad [8]$$

Therefore, for small peak-to-peak capacitive variations ΔC , the degree of peak-to-peak amplitude modulation is proportional to ΔC . If the average peak voltage of the rf carrier across the capacitance is V_o , then the magnitude of the maximum peak-to-peak variation in the voltage across the capacitance is $V_o(Q/2)(\Delta C/C)$. For a given bandwidth $2(\omega_0 - \omega_r)$ and a given ΔC , a small standing capacitance C , a large oscillator frequency ω_0 , and a large applied voltage V_o , a large output signal can be obtained.

For example, for a $\Delta C = 10^{-4}$ pF, a standing capacitance $C = .5$ pF, a bandwidth between 3-dB points of 30 MHz, and a resonant frequency of 900 MHz, then $Q = 30$ and $(Q/2)(\Delta C/C) = 3 \times 10^{-3}$. The equivalent shunt resistance across the capacitance is $Q/\omega C = 10^4$ ohms, and if $V_o = 10$ volts the peak-to-peak voltage will vary by 30 mV over this 10 kilohm resistance. This is equivalent to 2.6 mV if the output is stepped down to 75 ohms.

1.3 Signal-to-Noise Ratio Considerations

There are two basic noise sources to consider—the disc itself and the pickup circuitry. Let us first consider the noise generated in the circuitry. As in any electronic system, the major contribution to the noise level comes from the input circuit. In this case, there is not only a detector and first amplification stage but also an oscillator. The oscillator has been made very noise free by careful design. The basic approach was to use a very high Q resonant cavity. The relative importance of the other circuit noise sources depend upon the signal strength. The signal into the

detector is limited in amplitude due to voltage breakdown of the dielectric layer shown in Fig. 1. The peak voltage across the dielectric is limited to approximately 10 volts. The detector and amplification under these conditions are such that the noise from the pick-up circuitry is typically 10 dB below the noise detected from the disc surface itself.

The disc noise is therefore the limiting noise. In general, there are two classes of disc noise, additive and multiplicative. Additive noise is more significant, since it is related to surface texture and is a function of all processing and replication steps. It will be reduced by the FM limiting process but not completely removed. Multiplicative noises come from stylus elevation changes, which in turn change the detected carrier strength, and they are for the most part limited in bandwidth. If these modulations are not severe, they are greatly reduced in the limiting process. Another form of multiplicative noise can arise from improper mixing of the conductive compound in the disc. This noise can be quite wide band. If it is so wide band as to cause spectral overlap, it can not be entirely removed by limiting. Typical carrier-to-noise ratios are 50–60 dB in a 30 kHz bandwidth before limiting on a coated disc. Our minimum specification for acceptance is 49 dB for the innermost recorded radius, which is the worst case.

1.4 Merits of the Capacitive Pickup

At RCA, we have made and tested pressure and optical video disc pickups similar to those described in the literature. Examples of these pickups are described in Refs. [1], [2], [3], and [4]. All of these pickups are capable of reproducing high quality video signals from video discs. There are, however, some notable attributes of the capacitive pickup.

The capacitive pickup, like the pressure pickup, uses a light weight tracking arm guided by the shallow grooves to track over the signal elements in the disc. This eliminates the need for the tracking and focus servos required by an optical pickup, which lowers the relative cost. On the other hand, it makes special effects such as slow motion more difficult to do, which may be important in some applications. It should be noted, however, that repeat play of a few seconds is relatively easy to do by stopping the arm cage.

The resolution of the capacitive pickup is very high. The resolution limit of the system is in the recording and replication of the short wavelengths. Used to advantage, this high resolution translates into long playing time of the disc. The resolution of the pickup is limited only by the thickness of the electrode and its distance from the recorded elements. The resolution also does not significantly change with wear. The *stylus body* will change in dimension with wear, but the *electrode* dimension along the groove remains constant.

The capacitive pickup has an advantage in playing discs with mechanical distortions such as warp and out-of-round, which are problems encountered with all pickups. The stylus follows the disc distortions with no loss of tracking in most cases, but in tracking severe distortions the stylus will rock and lift the electrode edge off the disc. With the capacitive pickup, contact with the disc need not be maintained at the trailing edge as is the case with pressure pickups. The signal will be limited only by the constraints of Eq. [3].

The capacitive pickup also performs well in the presence of unavoidable debris. Large debris that would bother an optical pickup is usually brushed aside with the contact pickup. However, small debris that optical pickups can keep out of focus² sometimes get wedged under the stylus. Here again, the capacitive pickup continues to perform as indicated in Eq. [3] even if the stylus is lifted. Also it does not receive ill-defined and false signals through the debris, as a pressure pickup does.

The capacitive pickup does require a conductive disc. Formerly, this requirement was met by the application of relatively inexpensive coatings to one disc. The reflective optical video disc is also coated.⁵ The conductive plastic disc that we have developed has the advantage of reduced material and processing costs in comparison to the coated disc.⁶

2. The Buried-Subcarrier Encoding System

The buried subcarrier encoding system was developed to use the capacitive pickup to its best advantage in terms of picture quality and disc playing time. The constraints of the capacitive pickup are not unlike other pickups for video discs, however, and the same encoding system advantages will apply to these as well. The encoding system is based on the use of an FM carrier for the video information and separate FM carriers for the audio information in a single track. The buried-subcarrier encoding allows the color signal to be handled in the same channel as the luminance, produces a very high quality color picture, and allows a low video carrier frequency. A direct benefit of the low carrier frequency is long playing time for a disc, since the limitation is usually the shortest reproducible wavelength. This section first discusses the properties of the signal channel and then describes the encoding system and the parameters chosen for the overall VideoDisc system.

The encoding system that RCA uses for PAL and SECAM color standards is similar to the one described here, but the details of these signalling systems are different and will be covered in a future paper.

2.1 Signal Channel

The signal channel of the VideoDisc must store and reproduce a high quality color video signal and at least two high quality audio signals. After much research and testing, it was decided to use a single track containing a frequency-modulated video carrier and two frequency-modulated audio carriers. The characteristics of the other signal systems considered, many of them interesting in their own right, are not presented here. We instead concentrate on the characteristics of the chosen system.

All video disc signal-system channels suffer from some degree of nonlinearity and phase shifts. The result of these nonlinearities and phase shifts is to cause harmonics of signals and beats between signals. The derivation of these components is very complex. It is sufficient here to note the presence of those components and to explain how they constrain the encoding system.

Some of the consequences of these nonlinearities on the signal system can be described by considering, for example, an FM carrier of 5 MHz modulated with a deviation of 1 MHz by a 3-MHz sinusoid. The modulated carrier is subsequently ideally limited. This example is shown in Fig. 4. Let $J_{n,m}$ represent n th side frequency of the m th harmonic of the main carrier f_c . Then the components at the frequencies

$$f = mf_c \pm nf_m$$

where $m = 1, 2, 3$, $n = 0, 1, 2, 3$, and for $f_c = 5$ MHz and $f_m = 3$ MHz have the amplitudes indicated in Fig. 4. The second and third side frequencies

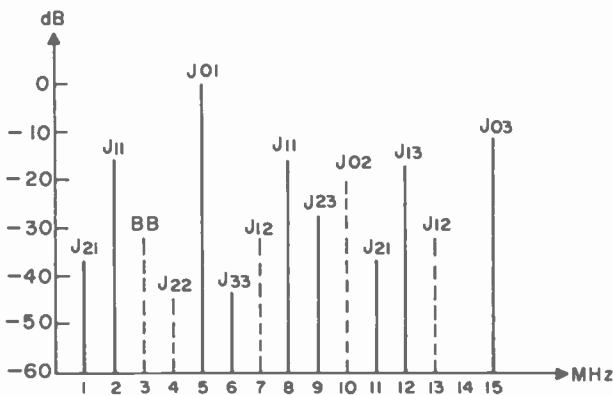

DASHED COMPONENTS ARE DISTORTIONS

ASSUMED: -20 dB 2nd HARMONIC, -30 dB BASE BAND

Fig. 4—Spectrum of a 5-MHz carrier modulated by a 3-MHz sinusoid after limiting.

of the main carrier, f_c , appear at 1 and 4 MHz respectively due to "frequency fold over" at zero frequency.

If the channel distortions are included, a baseband component may appear at 3 MHz. The amplitude of this component will depend upon the nonlinearities and phase distortions, but it is large enough in most cases that it must be considered in the system design. The components due to distortions are shown by dashed lines in Fig. 4. Another set of components due to nonlinearities is the 2nd harmonic of f_c at 10 MHz and its side frequencies.

In the VideoDisc, the video output from the FM demodulator is limited to a 3-MHz bandwidth. As a consequence, only components within 3 MHz of the main carrier are of major concern. There are two main interfering components to consider:

$$f_{i1} = f_m = \text{baseband component} \quad [9]$$

$$f_{i2} = 2f_c - f_m \quad [10]$$

where f_{ik} is an interfering frequency, f_m is the modulating frequency, and f_c is the main carrier frequency. This is illustrated in Fig. 4 for $f_c = 5$ MHz and $f_m = 3$ MHz. Note that

$$|f_c - f_{i1,2}| \geq 3 \text{ MHz} \quad [11]$$

when $f_c \geq 6$ MHz and $f_m = 3$ MHz. Under this condition, the interference does not appear in the video output.

Another of the channel distortions results from the combination of the video and audio FM carriers. We use two methods of combination depending upon whether the recorder is electron beam, optical, or mechanical. For the electron beam, duty-cycle modulation is used because the electron beam only responds to an "ON-OFF" modulation signal. In this case, the audio carrier is added to the video carrier and the result is hard limited. As an example, consider the video carrier and audio carriers to be

$$\text{video: } f_v(t) = \sin 2\pi f_v t \quad [12]$$

$$\text{audio: } f_a(t) = A \sin 2\pi f_a t, \quad [13]$$

where $A \ll 1$.

As a result of hard limiting of the sum of these signals, the spectral components of interest can be shown to have the amplitudes of the solid lines shown in Fig. 5. The only components normally within 3 MHz of f_v are those of $f_v \pm 2f_a$ (e.g. for $f_a = 0.7$ MHz, $f_v \pm 2f_a = f_v \pm 1.4$ MHz). These components are in fact due to amplitude modulation of the video carrier and will be removed by band pass filtering and limiting.

The recording, processing, and pickup of the duty cycle modulation

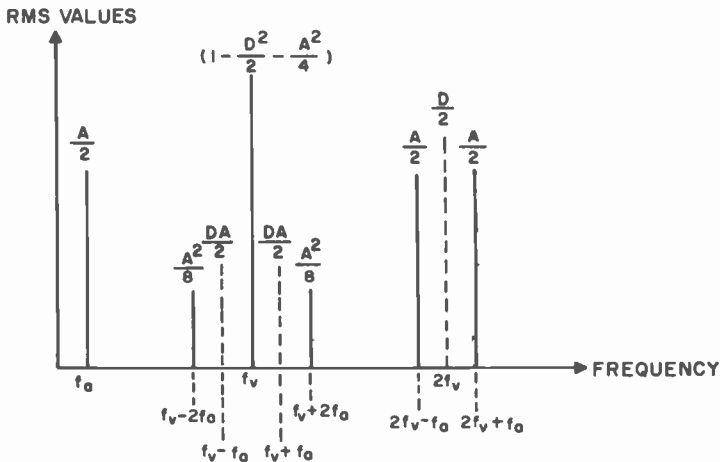

RESULT OF LIMITING $S(t) = \sin 2\pi f_v t + A \sin 2\pi f_a t + D$

Fig. 5—Spectrum of duty-cycle modulation.

is such that sometimes the average duty cycle will have an offset. This can be represented by adding a dc value to the sum of the signals. Let the sum signal $S(t)$ be

$$S(t) = f_v(t) + f_a(t) + D.$$

For small values of D the average duty cycle will be $0.5 + (D/\pi)$ rather than 0.5 when the duty cycle is defined as

$$\frac{t_1}{t_1 + t_2},$$

where t_1 and t_2 are the duration of the two parts of the cycle with $t_1 \geq t_2$. In this case, the spectral components would also contain the dashed lines in Fig. 5. The components of interest are at $f_v \pm f_a$. Again, in the ideal case they are due to amplitude modulation of the video carrier and will be eliminated by band-pass filtering and limiting.

In the actual case, these AM components of the video carrier may be changed to FM and be detected as interference. This can be caused by noncorrected frequency tilt or filtering before limiting in the player. The components at $2f_v \pm f_a$ are another major problem. They must have the correct phase or be attenuated significantly before the limiting in the player or phase modulation of the video carrier by the audio carrier will occur.

Another source of audio interference into the video is phase shifts in the pickup itself. As was noted in the description of the capacitive pickup, there will be an apparent shift in the position of the detected signal if

the elevation of the stylus is changed. If the recorded signal on the disc is not an ideal ON-OFF signal, there can be some vertical modulation of the recorded track by the audio carrier. This will be converted into phase modulation of the video carrier by the pickup. Fortunately, since the diamond or sapphire is always on the leading side of the electrode, the direction of the shift is known. The tolerance level of acceptable discs for phase modulation of the video carrier by the audio carrier can, therefore, be increased by approximately a factor of 2 by adding a signal to the video before encoding. This signal is the FM-modulated audio carrier but changed in phase such that it will tend to cancel any audio FM-carrier interference in the video. The level of this signal is so low that it is not visible in the final picture even if there is no interference. Alternatively, the audio carrier can be increased by a factor of 2 without changing the tolerance level.

For electromechanical and optical recording, the audio carrier is added in a linear manner to the video carrier. Here there are no components due to duty cycle modulation. In Fig. 5 only the components at f_v and f_a would appear in the encoded signal. The same nonlinearities of the system will apply, but there are fewer components to deal with and, therefore, fewer beats are generated. The stylus-to-track distance is now directly modulated by the audio carrier. This causes a very predictable response, and cancellation by an out-of-phase audio carrier is very effective.

2.2 The Encoding System

The encoding system is designed to reproduce high quality signals in the presence of the distortions shown in Figs. 4 and 5. These channel distortions affect the design decisions of video encoding, audio encoding, and their combination.

2.2.1 Buried Subcarrier Video Encoding

The luminance bandwidth of the system was chosen to be 3 MHz to be consistent with good resolution in a home receiver. From the baseband interference shown in Fig. 4, it would seem that the lowest FM video-carrier frequency would have to be 6 MHz for a 3-MHz luminance bandwidth. The components due to baseband interference at 3 MHz would then be 3 MHz away from the carrier. If the video information is all luminance information, this carrier can, in fact, be lowered. If the picture carrier were lowered to 5 MHz, the interference from the 2 to 3 MHz region of the baseband would cause interfering signals in the 2 to 3 MHz portion of the detected picture. Interference in this frequency band is, however, hardly noticeable partly because it is small and partly

because it is almost exclusively caused by edge information in the picture. As a consequence, the interference will only appear on the edges. The harmonics of these frequencies are not conveyed by the system since there is a 3-MHz low-pass final filter. In addition, the visual perception of noise components around an edge are masked by the edge.⁷ A continuous pattern of edges, such as a picket fence, is a special case but the above description still applies for the most part. The result is that little picture degradation occurs when the video carrier is moved down to 5 MHz for a luminance signal of 3-MHz bandwidth. It is quite another matter, however, if a chroma carrier or audio carrier is placed in this region. They will cause unacceptable visible continuous beats in flat areas of the picture.

One way to make use of this technique for lowering the video carrier frequency, thereby increasing the wavelengths and allowing increased playing time, is to record the color information in another channel such as by duty cycle modulation. The separation of luminance and chrominance into separate channels causes difficulties, however, since they must ultimately be matrixed together, and the amplitudes, frequency responses, and even the noise characteristics of the two channels should be matched.

For this reason, the concept of the buried color subcarrier was developed. Fig. 6A shows a typical spectrum of a video signal with a buried NTSC color subcarrier. The color subcarrier is placed at 1.53 MHz so that if the color carrier sidebands are less than 500 kHz, there will be no undesired color information within 3 MHz of the 5-MHz video FM carrier as a consequence of the interferences shown in Eqs. [9] and [10]. A comb filter technique allows the color signal to be placed in the luminance band and recovered in the player. This is possible because adjacent lines in a television signal contain closely related information. When all lines of a field are identical, the spectrum of the signal is discrete, with the energy concentrated at multiples of the line frequency f_H . When the lines are not identical, as in a typical picture, there will be some spread of the energy around each multiple of f_H , but the energy is still heavily concentrated in the vicinity of multiples of f_H . This was shown by Mertz and Gray.⁸ Because of this property of the video signal, it is possible to transfer the luminance signal through a comb filter as shown in Fig. 6B with minimal degradation of the picture. The frequencies from 1 to 3 MHz are combed, leaving the band below 1 MHz uncombed.

The quality of the picture when the video signal is passed through this filter suffers very little degradation. The comparison between a combed and uncombed video picture will be described in detail in a future paper. An example of what a comb filter does to a specific signal may help the understanding of the more general case, since it is somewhat difficult to visualize.

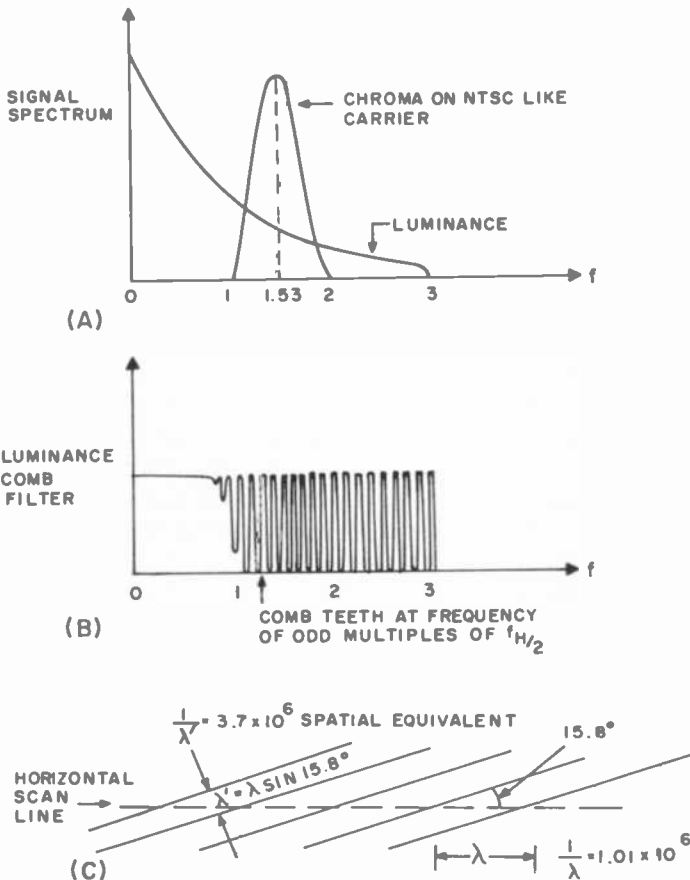

Fig. 6—Buried subcarrier video: (A) spectrum of typical video signal, (B) luminance comb filter, and (C) spatial pattern of a 1.01-MHz signal.

Consider a signal of 1.01 MHz which would fall in a comb tooth near the lowest frequency of combing and thus be rejected. If this signal were displayed on a TV screen, it would form the pattern shown in Fig. 6C or its mirror image. This pattern is a diagonal bar pattern at 15.8° from the horizontal scan line. The spacing along the scan line would be that of 1.01 MHz. However, the spatial equivalent frequency would be 3.7 MHz. Of course, this spatial pattern would not be reproduced either if it were oriented vertically, since the system has a 3-MHz bandwidth.

The chrominance information is also very similar from line to line. Therefore, the chrominance signal can be combed and placed on a carrier which is an odd multiple of $f_{H/2}$, specifically, we use $195f_{H/2}$ or 1.53 MHz. In this way, all components of the chrominance signal will be frequency

interleaved with the components of the luminance signal. As a consequence, the chrominance and luminance can be separated in the player by comb filtering. The chrominance signal can then be easily translated to the NTSC frequency of 3.58 MHz.

For a chrominance bandwidth of ± 500 kHz, the buried subcarrier system keeps the chrominance components below 2 MHz in the video band and allows the low FM carrier frequency of 5 MHz for a 3-MHz video bandwidth.

There is another advantage of the lowered chrominance carrier frequency when FM is used. Since the noise power density in an FM system is proportional to the square of the difference in frequency from the FM carrier, lowering the carrier frequency improves the SNR for a given chrominance carrier level. Lowering the frequency from 3.58 to 1.53 MHz improves the chroma SNR by 7.4 dB for a given carrier-to-noise level.

The placing of the chrominance at a relatively low frequency in the luminance band, a technique that we have called buried subcarrier, has several advantages. First, it allows a low FM carrier frequency even with channel distortions. Second, lowering the color carrier frequency improves the chrominance SNR when FM is used. Third, since the entire signal is contained in 3 MHz bandwidth, simpler video circuitry can be used. In fact, the player circuitry, which is described by R. N. Rhodes in another paper in this issue of *RCA Review*,⁹ uses a single inexpensive 1H delay line to separate the chrominance and luminance by combing and for defect substitution in full color.

2.2.2 Video Frequency Modulation

From the previous discussion, it is clear that with the buried subcarrier system the instantaneous frequency of the FM video carrier can be as low as 5 MHz without any perceptible beats in the picture. For this reason, the instantaneous frequency for black video level has been selected to be 5 MHz. As the video level moves from black toward white, the FM carrier is deviated upward in frequency. Therefore, as the video level moves toward white the interfering signals of Eqs. [9] and [10] will have less effect. Sync will deviate the carrier below 5 MHz. However, during the sync interval itself, there is no chrominance signal and, therefore, it cannot interfere with sync.

Since the interferences become less as the carrier frequency is raised, the upper carrier frequency can be chosen strictly on the basis of SNR and recorded wavelength, assuming that the CNR remains above the FM threshold.

The SNR ratio can be improved by pre-emphasis and de-emphasis of the higher frequencies. The pre-emphasis causes the video signal to swing higher than white level and lower than black level. If the swings

become too large, they must be limited or the wavelengths will become too short to be reproduced and the CNR will drop below the FM threshold. The optimization involves the parameters of CNR, desired SNR, white-level carrier frequency, pre-emphasis, and the transient effects caused by amplitude limiting.

The chosen system parameters are best described with the use of the video portion of the encoding block diagram (Fig. 7). The luminance portion of the comb filter is shown in Fig. 6B. The signal from the comb filter is pre-emphasized with a two-breakpoint network with the time constants shown in Fig. 7. The maximum pre-emphasis is approximately 12 dB at frequencies above 1 MHz. The pre-emphasis causes swings in the video which are amplitude limited at -66 and $+140$ IRE units.* This signal is then added to the chroma signal. The chroma signal portion of the comb filter is a band-pass filter of ± 500 kHz about 3.58 MHz with rejection teeth at multiples of f_H . This is equivalent to combing the

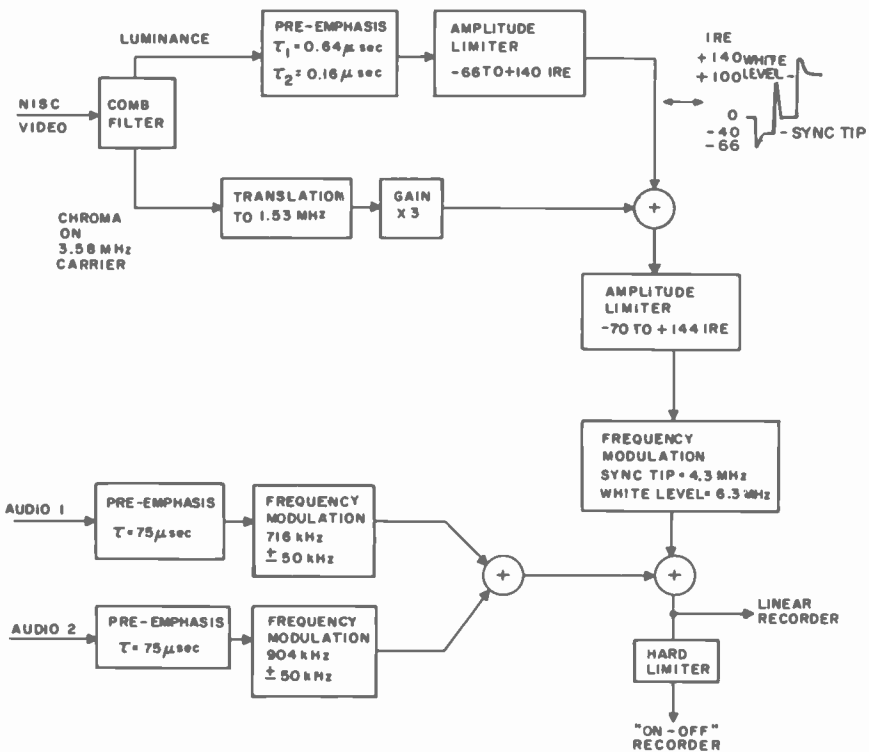

Fig. 7—Block diagram of encoding system.

* IRE units are defined for a video signal: blanking level = 0 IRE; sync tip = -40 IRE; white level = 100 IRE; black level is usually set at 7.5 IRE.

chrominance signals with a comb filter with rejection teeth at odd multiples of $f_{H/2}$ and modulating the result onto a 3.58 MHz carrier. The output of the chroma comb filter is translated to 1.53 MHz and is amplified to a value 3 times that of a standard chroma signal before it is added to the luminance signal. This increase in chroma increases the chroma SNR during playback. Adding this increase to the increase obtained by lowering the carrier frequency more evenly balances the noise contributions from chrominance and luminance.

The resultant sum is again limited to slightly wider levels, -70 and $+144$ IRE units, to avoid relimiting the luminance signal in the presence of the chroma signal, which would cause some undesired cross products before application to the video FM modulator. The carrier frequencies are 4.3 MHz for sync tip and 6.3 MHz for white level. This also fixes the limit levels to be 3.9 and 6.9 MHz and black level at 5 MHz. It should be noted that the pre-emphasis has forced the highest frequency from 6.3 to 6.9 MHz. If the white level instead was moved to 6.9 MHz, the SNR_w would be increased 3.3 dB. The pre-emphasis, however, increases the SNR_w 10.8 dB, giving a much better trade-off for the increase in carrier frequency while maintaining good transient response.

2.2.3 Audio Encoding

The placement of the audio carriers also requires careful consideration. If the audio carriers are placed below 2 MHz, they will not directly interfere with the video. However, baseband video may cause interference in the audio channel. It is, therefore, desirable to keep the audio carriers below 1 MHz so that the relatively high level chroma carrier at 1.53 MHz in the baseband signal can be avoided. The very low frequencies are also undesirable because of large luminance components. In addition, there is more disc noise at low frequencies. For these reasons, the frequency band between 0.5 and 1.0 MHz was selected for the audio carriers. Within this band, the frequencies are chosen such that any audio interference from the components at $f_v \pm f_a$, as shown in Fig. 5, into the video will be interleaved with the video spectral components. This lowers the visibility in the picture considerably, even though they cannot remain interleaved as the carrier is frequency modulated. The two audio-carrier frequencies were chosen to be $91f_{H/2}$ and $115f_{H/2}$.

The audio encoding is shown also in Fig. 7. The two audio signals have a bandwidth of 20 Hz to 20 kHz. Each signal is pre-emphasized for a playback de-emphasis time constant of 75 μ sec. The two audio carriers have a maximum deviation of ± 50 kHz at frequencies of 716 and 905 kHz, respectively.

The levels at which the audio signals are added to the video carrier signal depends upon the recorder. The input to the linear recorder is the

sum of the audio and video carriers, and the audio levels are 20 dB below the video carrier. The "ON-OFF" recorders use duty cycle modulation and the audio carrier levels are 17 dB below the video carrier before limiting; limiting lowers the level 6 dB. It should be noted that with duty cycle modulation, each audio carrier changes the duty cycle by $\pm 4.5\%$. This, of course, changes the smallest recorded and reproduced signal element accordingly.

2.2.4 Audio Video Combination

A detailed discussion of the interaction of the audio and video and the accurate derivation of the magnitude of the beats between them and the way the signal system deals with them is beyond the scope of this paper. What follows is, therefore, only an overview of the subject.

Consider first the case of audio encoding by duty cycle modulation. Fig. 5 shows the result of duty-cycle modulation of the video carrier. In the more general case, the carrier will be frequency modulated with video. All of the components in Fig. 5 with the exception of those at frequencies of 0 and f_a will be frequency modulated. The deviation of each component by video information will be proportional to the multiples of f_v (e.g., the deviation of the component at $2f_v - f_a$ will be twice that of the component at $f_v - f_a$). All of these components will have video FM sidebands with amplitudes related to the component amplitudes and their deviations.

Fig. 8 shows the approximate spectrum for a single audio carrier with amplitude $A = 0.14$ (see Eq. [13]) and a video carrier that is modulated with a full-amplitude color carrier without including any distortions indicated by the dashed lines in Figs. 4 and 5. Fig. 8A shows the video at black level and Figure 8B the video at white level. The spectrum only includes components more than 40 dB below the level of the main video carrier and does not show the luminance modulation components. When the distortion components are added in, the result is even more complicated and is not reproduced here. The interferences in Fig. 8 may seem very large. The parameters of the system, however, were chosen in accordance with the previous discussion and are consistent with a very high quality picture. In fact, the distortion components of baseband and 2nd harmonic shown in Figs. 4 and 5 are more significant.

There are a number of properties of the signal system that counteract the interferences. First, not all of the frequencies occur at the same time and certain interferences that might appear to overlap during video modulation never do overlap because they move together. Second, only components within 3 MHz of the frequency as averaged in the detector low pass filter are of significance. Third, components that are only on one side of the video and audio carriers are reduced 6 dB in the limiting

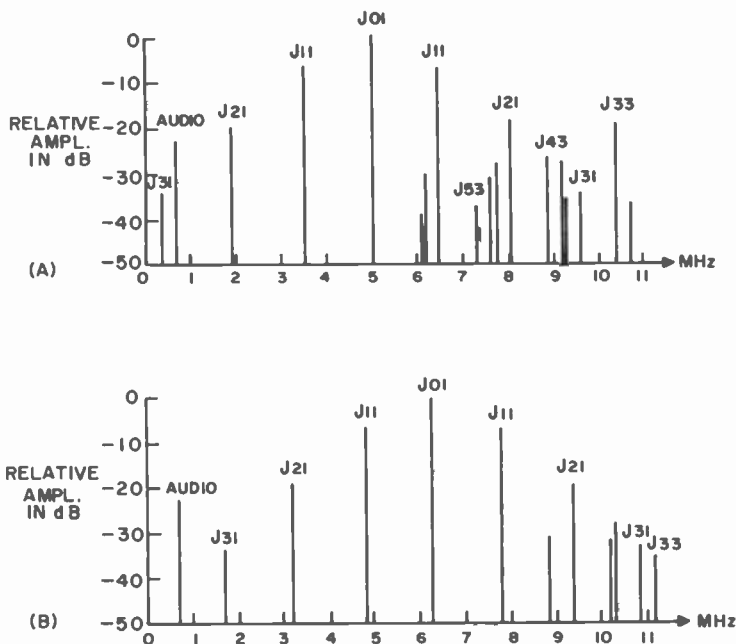

HARD LIMITING OF $S(t) = f_v(t) + A \sin 2\pi f_0 t$
 VIDEO CONTAINS 100% AMPLITUDE COLOR CARRIER
 TERMS LABELED J_{ik} ARE VIDEO ONLY COMPONENTS

Fig. 8—Spectrum of video and audio combination by duty-cycle modulation: (A) luminance at black level and (B) luminance at white level.

process. Fourth, de-emphasis by the luminance and audio networks and the chroma three-times gain reduction in the player reduces the interference significantly. Fifth, the visibility of some interferences are low even though their measured value may be significant; e.g., interference in the picture has reduced visibility if the interfering frequencies are interleaved with multiples of f_H .

The other case is audio encoding by the linear addition of audio and video carriers. This case is shown in Fig. 9 and is much simpler than the spectrum of Fig. 8. In this case, it is also possible, if desired, to reduce the spectral components of the video FM carrier at the audio carrier by filtering.

It should be noted, however, that although the spectrum at the encoder is less complex, the nonlinearities and distortions of the channel still apply, and the signal system must be designed to handle them. The inclusion of baseband and 2nd harmonic distortion components is shown in Fig. 10.

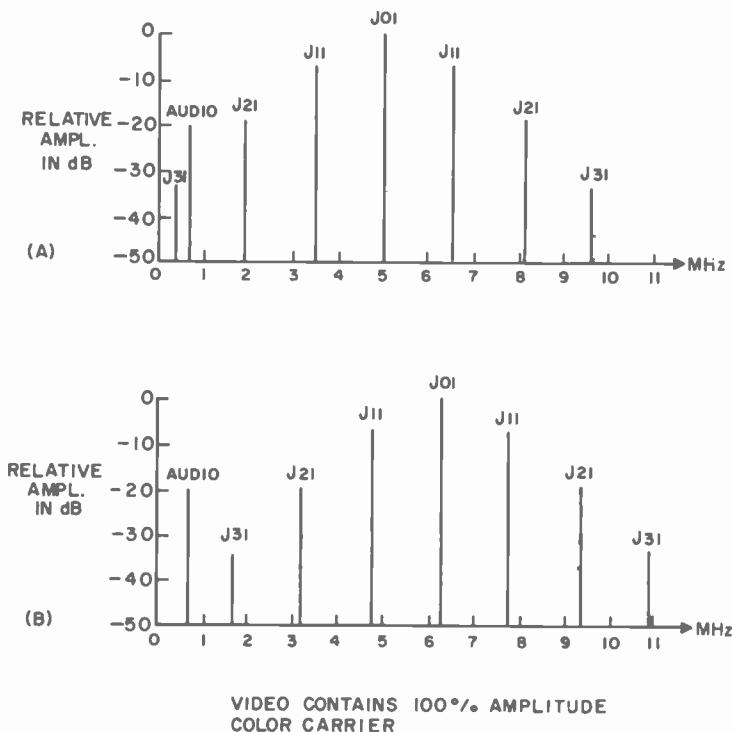

Fig. 9—Spectrum of video and audio combination by linear addition: (A) luminance at black level and (B) luminance at white level.

2.3 System Parameters

Beside the signal system parameters discussed above, the other system parameters of importance are groove pitch (GP), disc rotations per minute (RPM), outer recorded radius (R_o), inner recorded radius (R_i), and disc playing time (PT). These parameters can not be independently chosen and must relate to outside constraints, the most important of which are minimum recorded wavelength (λ_{min}), stylus life, tracking, and effects of defects. There are, of course, many other constraints.

The most crucial constraint is λ_{min} , which should be kept as large as possible. Longer wavelengths are easier to record, easier to replicate, easier to resolve with the pickup, and cause less signal loss due to electrode lifting from either debris or severe disc warp.

A stylus is worn out when it becomes too wide or too long to play well. If it becomes wider than a groove it will pick up adjacent groove signals and if it is too long the electrode will lift when playing warped discs. For a fixed playing time and recorded area, the groove pitch is inversely re-

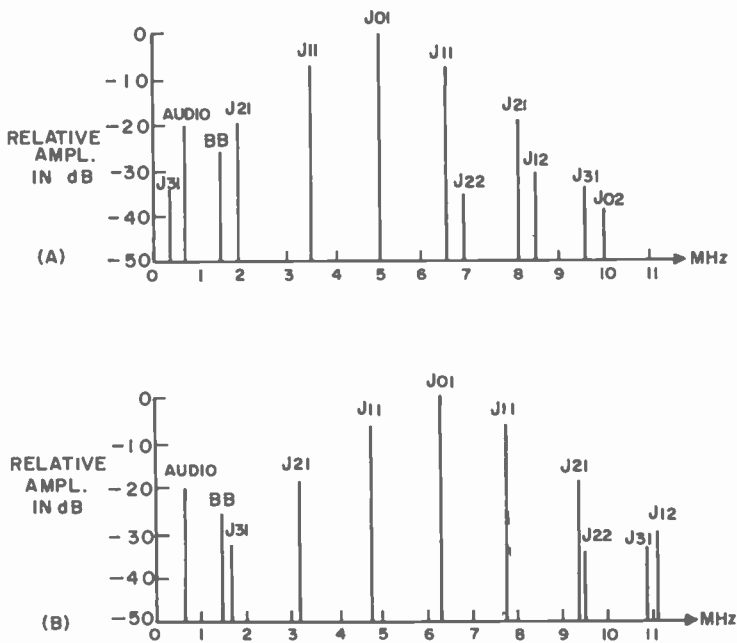

VIDEO CONTAINS 100% AMPLITUDE COLOR CARRIER
 DISTORTION ASSUMED: -30 dB BASE BAND,
 -26 dB 2nd HARMONIC

Fig. 10—Spectrum of video and audio combination by linear addition with distortion: (A) luminance at black level and (B) luminance at white level.

lated to the RPM. As the RPM is lowered, the GP can be increased. This will increase stylus life because with a low RPM the stylus has less distance to travel causing less wear per hour and with a high GP the stylus can become wider without exceeding the width of a groove. Of course, with lower RPM the recorded wavelengths are shorter. This forces the trade-off between stylus life and minimum recorded wavelength. This trade-off is relieved somewhat by recent advances in the shapes of styli, which now change width very slowly with wear.

Tracking is also easier for a large GP and low RPM. This, however, is not a major factor since the tracking ability is quite good over a range of GPs and RPM.

Defects are inevitable in mass production of discs. The system must be able to handle these defects gracefully. For this reason, a large GP is also important, since a defect will cover a smaller number of grooves.

On the basis of the above, the RPM should be as low as possible and λ_{\min} and GP should be as large as possible.

For a constant RPM disc, the parameters are related by

$$PT = \frac{(R_o - R_i)}{RPM \cdot GP}, \quad [15]$$

and the minimum groove velocity is

$$v_{min} = 2\pi R_i \cdot RPM. \quad [16]$$

If f_{max} is the highest frequency, then

$$\lambda_{min} = \frac{v_{min}}{f_{max}} \quad [17]$$

Eqns. [15] and [16] can be rewritten to yield GP as a function of R_i ;

$$GP = \frac{2\pi(R_o - R_i)(R_i)}{PT \cdot v_{min}}. \quad [18]$$

This shows GP to be a maximum when $R_i = R_o/2$ for fixed PT and λ_{min} . Alternatively, λ_{min} can be found as a function of R_i ;

$$\lambda_{min} = \frac{2\pi(R_o - R_i)R_i}{PT(f_{max})GP} \quad [19]$$

For fixed GP, PT, and f_{max} , λ_{min} is a maximum for $R_i = R_o/2$. Therefore, both conditions of large GP and large λ_{min} are optimized for $R_i = R_o/2$ under the above constraints. This optimum, however, is broad, and small changes about $R_i = R_o/2$ are inconsequential.

Fig. 11 show GP versus λ_{min} for various playing times and for $R_o = 2R_i = 14.5$ cm. In this case, λ_{min} was calculated for $f_{max} = 6.9$ MHz. This frequency is the limit level of the video and not of the white level, which would be 6.3 MHz. RPM is also indicated for certain specific RPMs on the λ_{min} axis. It is desirable to keep an integral number of TV frames in one revolution. This allows the possibility of "live search," that is, searching for a particular spot in the disc with the stylus down, without affecting the periodicity of the sync signals. 600, 450, 360, and 300 RPM correspond to 3, 4, 5, and 6 frames per revolution, respectively.

The system goal was a disc with 60 min. playing time per side. The parameters were then set with PT = 60 min. Since there is not a sharp optimum at $R_i = R_o/2$, R_i can be varied to match other constraints. Fig. 12 shows λ_{min} versus GP with RPM as a parameter, when R_i is allowed to vary. It can be seen that simultaneous large λ_{min} and large GP is not possible. If there is a limit on λ_{min} , however, there is an optimum RPM and GP at this limit.

Due to the constraints mentioned above, the system parameters selected are

$$\begin{aligned} PT &= 60 \text{ minutes} \\ RPM &= 499.550 \text{ (4 fields per revolution)} \\ GP &= 2.66 \mu\text{m (9541 grooves per inch)} \\ R_o &= 14.5 \text{ cm (5.7 inches)} \end{aligned}$$

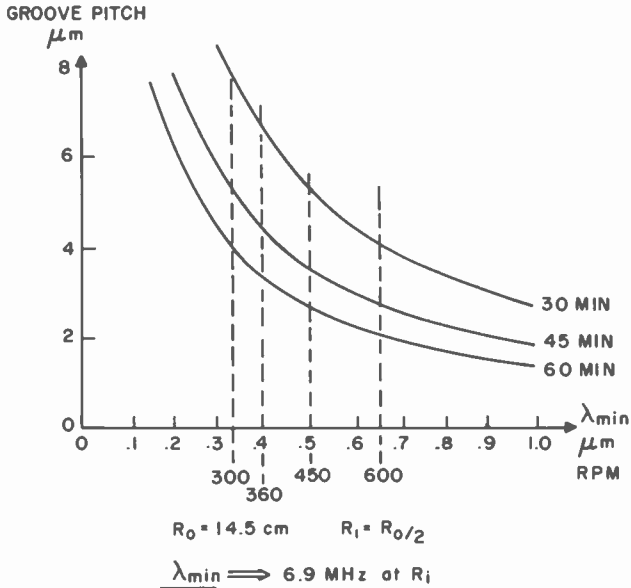

Fig. 11—Groove pitch versus λ_{min} for various playing times and RPM with $R_i = R_0/2$.

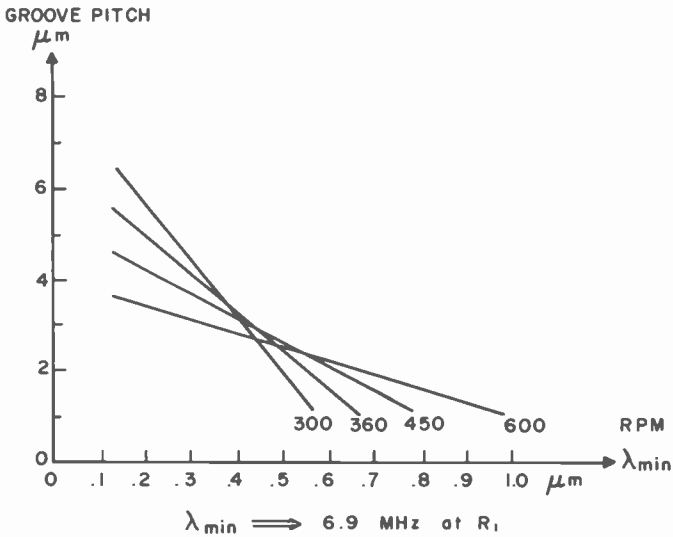

Fig. 12—Groove pitch versus λ_{min} for various RPM for a 60-minute disc.

$$R_i = 7.3 \text{ cm (2.9 inches)}$$

$$\lambda_{min} = 0.50 \mu\text{m (6.9 MHz @ } R_i)$$

$$\lambda_{max} = 1.75 \mu\text{m (3.9 MHz @ } R_o)$$

2.4 System Performance

Because RPM is constant, the performance at an inner radius is inferior to that at an outer radius. The system is designed to give high quality pictures at the inner radius, which is reached after 60 minutes of play. This means, of course, that the performance of most of the disc is superior to the design point.

Fig. 13 shows a typical signal and noise response obtained at the arm pre-amplifier output when playing a 60-minute coated disc. The signal frequency response at the inner radius must be corrected before the signal from the arm is supplied to the limiter in the player. The needed frequency-response correction or aperture correction is small enough and so uniform and predictable, however, that the correction can be set in the player and no adjustment is needed to play the outer and inner radius. Automatic aperture correction is, therefore, not used and the aperture correction is set in the factory.

Due to the high resolution of the pickup and the recorder (see Ref. [10]), the inherent phase response of the system is very good. This good phase response and the amplitude response shown in Fig. 13 allow high-quality video signal responses, such as transient response and differential gain and phase.

The noise response in a 30 kHz bandwidth is only shown in Fig. 13 at the inner radius. The amplifier noise is well below the disc noise over the frequencies of interest.

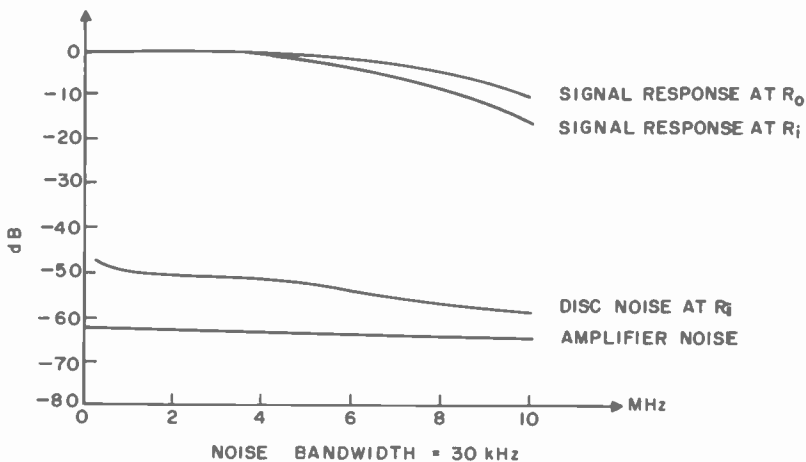

Fig. 13—Signal and noise response for a 60-minute coated disc.

The video SNR obtained when playing a disc is a function of the signal and noise responses shown in Fig. 13 and FM signal parameters. The pre- and de-emphasis was chosen to minimize visible noise and gives a 10.8 dB reduction in noise when measured with CCIR weighting. There is also a 2.2 dB improvement in measured SNR due to the combing of luminance. The measured video and audio SNR when playing a coated disc are shown in the following table. The results obtained when playing a conductive disc at the present time are approximately 2 dB lower than these values.

Table 1—Measured Performance

$$\text{Video SNR}_w = 20 \log \frac{\text{black-to-white signal}}{\text{RMS noise}} \text{ CCIR weighted}$$

$$\text{Audio SNR} = \frac{\text{RMS 400 Hz 100\% modulated signal}}{\text{RMS noise in 200-15000 Hz filter}} \text{ unweighted}$$

Video SNR_w = 52 dB typical

Video SNR_w = 48 dB lowest accepted at 60th minute

Audio SNR = 57 dB typical

Audio SNR = 55 dB lowest accepted at 60th minute

3. Conclusions

The capacitive pickup as shown in this paper is an excellent pickup for consumer video disc systems. The light weight tracking arm in conjunction with the grooved disc allows an inexpensive system without tracking or focus servos. Although the sliding stylus must wear, the resolution does not change with wear if contact with the disc is maintained. The end of stylus life is reached when the stylus becomes wider than a groove and it then can be inexpensively replaced. In addition to providing excellent signal reproduction under normal conditions, the pickup performs very well under adverse conditions. When the stylus and electrode is lifted due to defects in the disc, debris on the disc, or disc distortions such as warp, the signal is reduced only according to the height it is lifted and the signal quality is merely temporarily reduced.

The buried subcarrier encoding system as shown in this paper is a very efficient high quality video encoding system. In the presence of nonlinearities and distortions normally occurring in video discs, the FM carrier can be placed at a comparatively low frequency. This translates directly into longer playing time for a disc because the recorded and

reproduced wavelengths are longer. The chrominance carrier frequency is lower than the NTSC chrominance carrier frequency yielding a higher chrominance SNR after FM demodulation. In addition, the chrominance and luminance signals are handled together, permitting high quality decoding with inexpensive player electronics.

Acknowledgments

The members of the Signal Systems Group have contributed heavily to the concepts described in this paper and in efforts to successfully develop the system. Their contributions will become more apparent in future papers dealing with the details alluded to in the text. The members of this Group are: J. J. Gibson, H. Kawamoto, R. C. Palmer, M. D. Ross, R. L. Truesdell, and until recently, J. S. Fuhrer and H. G. Schwarz. Other contributors were: J. Amery, J. P. Bingham, T. Christopher, E. O. Keizer, D. H. Pritchard, A. C. Schroeder, H. Wharton, and J. Wilder.

References

- ¹ C. Bricot, J. C. Lahureau, and C. Puech, "Optical Readout of Videodisc," *IEEE Trans. Consumer Electronics*, CE-22, No. 4, p. 304, Nov. 1976.
- ² P. W. Bogels, "System Coding Parameters, Mechanics, and Electro-Mechanics of the Reflective Video Disc Player," *IEEE Trans. Consumer Electronics*, CE-22, No. 4, p. 309, Nov. 1976.
- ³ I. Gorog, "Optical Techniques Developed for the RCA VideoDisc," *RCA Review*, 39, No. 1, p. 162, March 1978 (this issue).
- ⁴ G. Dickopp and H. Redlich, "Design Simplicity Cuts Costs for German Color Video Disk System," *Electronics*, 46, No. 20, p. 93, Sept. 27, 1973.
- ⁵ J. S. Winslow, "Mastering and Replication of Reflective Video Discs," *IEEE Trans. Consumer Electronics*, CE-22, No. 4, p. 318, Nov. 1976.
- ⁶ L. P. Fox, "The Conductive VideoDisc," *RCA Review*, 39, No. 1, p. 116, March 1978 (this issue).
- ⁷ R. Cohen, "Applying Psychophysics to Display Design," *Proc. International Conf. Psychophysics of Image Evaluation*, Rochester, N.Y., Oct. 1977.
- ⁸ P. Mertz and F. Gray, "A Theory of Scanning and Its Relation to the Characteristics of the Transmitted Signal in Telephotography and Television," *Bell Systems Tech. J.*, 13, p. 464, July 1934.
- ⁹ R. N. Rhodes, "VideoDisc Player," *RCA Review*, 39, No. 1, p. 198, March 1978 (this issue).
- ¹⁰ E. O. Keizer, "VideoDisc Mastering," *RCA Review*, 39, No. 1, p. 60, March 1978 (this issue).

VideoDisc Mastering

E. O. Keizer

RCA Laboratories, Princeton, N.J. 08540

Abstract—Three different methods were developed for making master recordings from program material for the RCA VideoDisc system—electron beam, optical, and electromechanical. Materials, processes, and recorders were developed for each method. Each method has produced high-quality masters and each has its advantages. This article presents a summary of the development and results achieved with each method, and of the reasons for now preferring the electromechanical method. The signal-encoding system and the disc format used in mastering are described in companion articles^{1,2} in this issue of *RCA Review*.

1. Introduction

As indicated in a preceding article³ in this issue of *RCA Review*, simplicity of the player and low cost per hour of play of the finished discs, along with high performance, were paramount goals in the development of the RCA VideoDisc system. The resultant 450-rpm grooved-format disc, optimized for long stylus life and long play time, imposed problems on mastering that required a very substantial amount of exploration and development effort to solve. The problems were in four general areas:

- (1) Finding materials and technology for reliably recording with sufficient resolution to make well-defined topographical signal elements approximately 1000 Å deep and as short as 0.25 μm, with a high degree of surface smoothness.
- (2) Recording in real time, which required the making of signal elements at an average rate of 5 MHz.
- (3) Doing the above in a fine spiral groove, maintaining uniformity of

its cross-sectional shape and of the amplitude of the signal elements.

(4) Developing processes for obtaining from the original recording a flaw-free metal master qualified to be the starting point for fan-out to stampers for use in pressing thousands of finished discs.

During the early part of the program diverse tests of an exploratory nature were made with different materials, recording techniques, and replication processes. Many of these had utility beyond the scope of this article by providing sample replicas useful in testing pickups and other components of the system. When a steady supply of full-sized disc masters was needed for overall system development, electron-beam mastering was chosen to supply that need, and along with a particular method of processing received the main thrust of development work over a period of several years. Its versatility in generating different types of signal patterns was particularly useful in making the variety of masters needed for testing system variations. More than 2500 masters were made; some were replicated in quantity—over 300,000 discs were derived from them. Meanwhile, the concurrent development of both optical and electromechanical mastering methods resulted in the solution of their basic problems and demonstrated their capability of also producing high-quality masters. Each method has unique advantages, and will be discussed in this paper.

In addition to criteria that are strictly technical, the choice among mastering methods also depends on commercial considerations such as capital and operating costs, yields, ease of evaluation, etc. On the basis of both technical and commercial criteria, electromechanical mastering is presently the preferred approach and is currently receiving the most effort in continued development for mastering of the RCA VideoDisc System.

2. Electron-Beam Mastering

For electron-beam recording, a metal disc containing a precut spiral groove is coated with an electron-beam-sensitive material, typically a positive-acting photoresist, and mounted on a turntable in a vacuum chamber. Smooth rotation of the turntable is achieved by driving it with jets of vacuum pump oil. The rotational speed is measured by an optical tachometer, and is accurately locked to the signal-generating rate by means of servo control of the oil flow. The turntable rotates under an electron-optical column and translates under it at about 20 $\mu\text{m}/\text{sec}$ to keep the groove continuously in line with column axis, while the beam is deflected slightly so it remains centered in the groove while it exposes

the resist. The beam is blanked on and off according to the applied signals representing the video and sound information.

Following exposure, the resist is developed chemically to produce the desired relief-pattern track in the spiral groove. Evaporation of a thin conductive layer onto the recorded master, which is built up further by electroplating and separated from the original master, produces a negative metal master. Further generations of metal parts for molding the final plastic discs are made from it by methods similar to those used in the audio record industry and are described in a companion article by R. J. Ryan.⁴

2.1 Processing

Materials Selection

A number of available materials were screened for resolution, smoothness, and sensitivity using available electron-beam and optical exposure sources. The materials screened included ablative materials, dichromated gelatins, photoconducting thermoplastic materials, photochromic plastic materials, silver halide materials (both evaporated and in emulsion), and both positive- and negative-working photoresists. Of these, a positive-working photoresist, Shipley AZ-1350* was selected for use in succeeding experiments on the basis of its high resolution and smooth surface, suitability for use with either optical or electron beam exposure, and commercial availability. It was used extensively until new recording materials, described later, were developed.

Process Selection and Techniques

The initial plan for making the grooved, coated substrates was to machine the groove into a lacquer coating, replicate it by standard audio matrix techniques to produce many nickel copies with identical groove shapes, and then apply a thin conformal coating of the resist to the copies.

With a thin conformally coated substrate, an exposed signal element forms a hole after development, as shown in Fig. 1a. Three ways of forming a metal replica or master from it are shown in Figs. 1b, 1c, and 1d:

(1) Etching, preferably ion sputter etching to avoid undercutting, may be used to transfer the holes to the substrate as shown in Fig. 1b. For this

* Registered trade name of the Shipley Co., N.J.

method, the substrate should be grooved, and the metal master will be a "positive", i.e., will be like the resist master.

(2) Metalizing of the surface, for example by evaporating $\approx 500 \text{ \AA}$ of gold onto it, then electroplating to form a layer approximately 0.2 mm thick, followed by separation from the EB substrate master as shown in Fig. 1c. For this method the substrate also should be grooved, but the metal master will be a "negative" of the resist master.

(3) Selective electroplating into the holes in the resist coating, then dissolving away the resist material, to build up a signal element on the

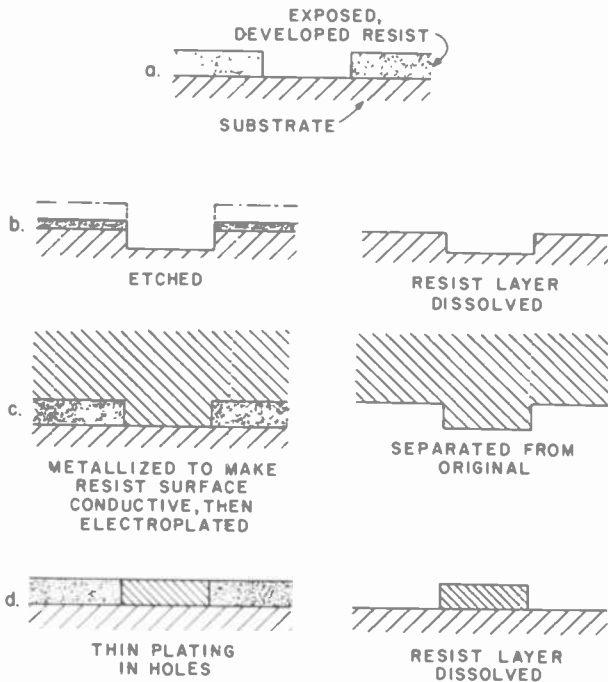

Fig. 1—Methods for transferring a signal element hole that has been developed in a thin layer of photoresist to the metal substrate: (a) hole formed by exposure and development, (b) hole-to-hole transfer by ion etching, (c) hole-to-bump transfer by plating a thick overall layer, and (d) hole-to-bump transfer by selectively plating in the hole.

substrate as shown in Fig. 1d. For this method the substrate itself should be a negative, having ridges instead of grooves, and the resulting metal master will be a negative similar to that obtained by method (2) above, although made by a different process.

In the early stages of the system development, the groove was rela-

tively deep and coarse, making conformality and uniformity of thickness of the resist coating particularly difficult, and the above methods were of limited usefulness.

Another general approach to making a recording master that was explored was that of applying a thick coating of resist to a flat substrate disc and forming a groove in the resist by one of several techniques: machining, recording with a beam of light or electrons, or molding. The desired groove-surface smoothness was difficult to achieve by this approach. In the approach selected for another development a groove, deeper than the desired final groove depth, is machined into the surface of the metal substrate, and a coating ($\approx 2 \mu\text{m}$) of resist in dilute solution is applied to the substrate. As the solvent evaporates, the surface of the resist sags to form a smooth, uniform, and shallower groove above the substrate groove.

It was found that a 0.5-mm-thick bright copper layer electroplated upon a smoothly machined flat $\frac{1}{2}$ -inch aluminum disc provided an excellent substrate material into which to machine the groove with a sharp diamond cutting tool. The finish machining and groove machining of the substrate demands high precision and was done on a modified jig-bore (see Fig. 2). Controls introduced in plating, cutting tool profile, and machining techniques resulted in a consistent product with excellent surface finish.

Application of the resist to the surface of the grooved substrate was done by a spinning process. After a brief period at approximately 450 rpm to help level the dilute solution, the master disc was spun continuously at a lower speed in a clean room (class 100 environment) until the solvent evaporated. The uniformity of the coating thickness and of the groove cross-sectional shape were both quite repeatable by this process, and no difficulty was experienced in maintaining the thickness at $1.0 \pm 0.1 \mu\text{m}$ for a groove depth of $0.3 \mu\text{m}$, which was used for the 5555-groove-per-inch (GPI) $\frac{1}{2}$ -hour-per-side format. For this GPI format, trapezoidal-cross-section substrate grooves (see Fig. 3) were used to provide the desired slightly cusped groove shape. For the one-hour-per-disc-side, 9541-GPI format, triangular-cross-section substrate grooves were required to provide a desired final groove depth of $0.2 \mu\text{m}$.

The treatment of the coated master before exposure, the type of development, and the treatment after development to prepare it for replication depended on the type of resist used. For Shipley AZ-1350 resist and for the Mark II' material described later, carefully controlled drying and storage before exposure were useful in keeping the sensitivity uniform. Development by immersion was superseded by spray development, which minimized staining of the surfaces. The exposed, developed

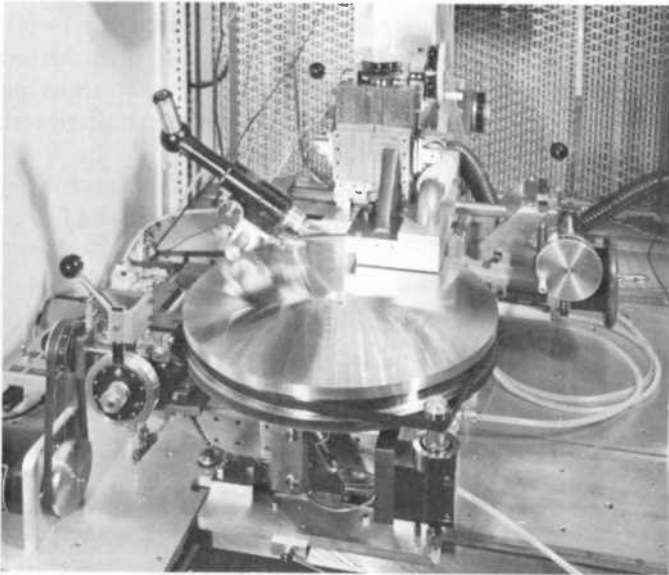

Fig. 2—Modified jig bore with hydrostatic turntable used for master substrate machining.

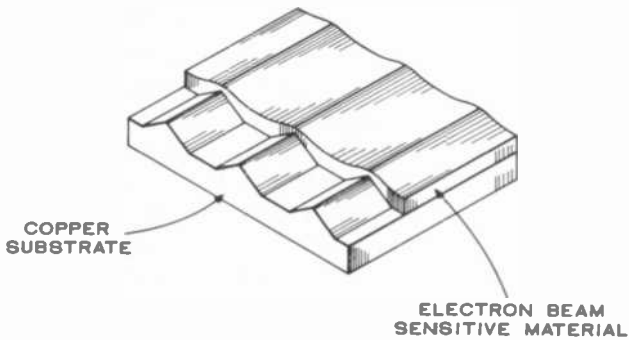

Fig. 3—VideoDisc groove formation (sag-coated resist on grooved substrate).

masters were baked, then metalized by evaporating a thin ($\approx 500 \text{ \AA}$) layer of gold onto them. Then they were optically tested for surface defects and for signal characteristics.⁵ Finally, a metal master was made by electroforming a 0.20-mm-thick nickel layer on the metalized resist master and then separating it from the resist master.

For the full-sized discs, a test signal (see Fig. 4) was recorded near the outer and inner radii of the master. This signal included a few cycles each

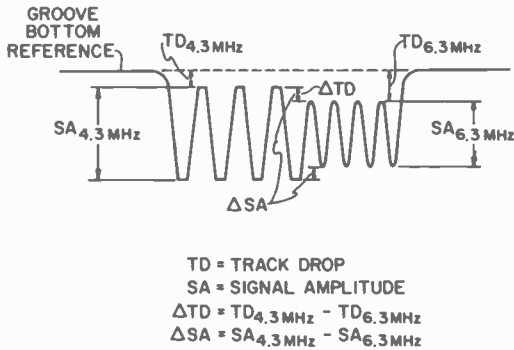

Fig. 4—Drawing showing an idealized pattern formed using SW7 test signal and quantities measured from it.

of 4.3 MHz and 6.3 MHz signals of controlled, repeatable phase relationship. By scanning-electron-microscope (SEM) evaluation of small samples punched from a replica of a master, the relative amplitude of the 6.3 and 4.3 MHz signals could be measured; for good playback performance, a ratio of greater than 0.7 was desired. The tops of these high-frequency signals generally lie slightly below the unexposed surface of the groove and by different amounts. The difference, called “ Δ track drop”, was also measured. To avoid sound beats in the recovered picture, it was important to keep this difference below 150 \AA . Specifications for signal depth ($800\text{--}1000 \text{ \AA}$) for the master were a compromise between a large enough depth to provide a good playback signal level and a small enough amount of “ Δ track drop”. Shallower signal elements, e.g., $300\text{--}500 \text{ \AA}$ deep elements, would provide adequate recovered signal quality under normal playback conditions. However, the deeper signal elements that are specified provide a margin of signal level that results in greater immunity to adverse conditions that slightly lift the stylus, such as the accumulation of some types of debris under the stylus.

To aid recording speed, the exposure level was kept as low as possible, just above the threshold of sensitivity. Consequently, to meet the specifications, a high degree of control of the resist exposure and processing

was needed. The amount of electron beam exposure could be controlled to $\pm 5\%$. The spot size was reduced to a half-intensity width of about $0.12 \mu\text{m} \pm 0.02 \mu\text{m}$ by recorder developments, which are outlined later. Another factor in the reproducibility of signal depth and shape was variation in the solubility of the resist. To reduce this variation was one of the major reasons for developing an improved resist and for careful standardization of each step of the procedure. In addition, before use, each new lot of resist was characterized and adjustments made (e.g., in development time) to compensate for changes in sensitivity or solubility rates. With careful control, the spread in effective sensitivity and signal depth was in the order of $\pm 20\%$.

An extraneous particle can result in several types of defects on the finished master. If it adheres to the resist surface at the time of replication, it will produce a hole in the metal master and a bump in the final disc. If it adheres to the resist master before exposure and development, it can cause local desensitization of a 5- to 50- μm diameter circular area surrounding the particle; there is no removal of resist from this area during development so it remains as a raised plateau that appears as a shiny spot by visual inspection. The number of surface defects was reduced by thorough cleaning, filtering of liquids, and doing all processing in the class 100 clean room atmosphere.

2.2 Recorders

Developmental

High-quality scanning electron microscopes became commercially available just in time to be useful in many areas of development of the RCA VideoDisc project. In no area were they more useful than in the development of electron-beam mastering. Not only were they excellent for evaluating results, but they provided an available source of a small-diameter controllable beam for making test exposures. Transfer of the electron-optical column of an SEM to a vacuum chamber large enough to handle a 14-inch diameter grooved and coated substrate on a turntable and drive mechanism was a key element in constructing the first experimentally useful full-sized electron-beam disc recorder (see Fig. 5). Techniques for blanking the spot off and on and for deflecting it to form desired test patterns were used with the column in the normal SEM position. For full-sized mastering the column was moved to the recorder position. Typical results are seen in Fig. 6.

The recording depicted in Fig. 6 used signal elements with segments of varying lengths to generate a particular experimental form of ampli-

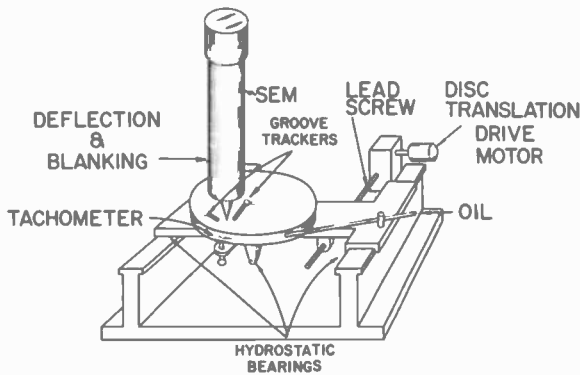

Fig. 5—Simplified schematic drawing of EB disc recorder.

tude modulation that was being tested at the time. The electron beam used to make the pattern was circular in cross section, and was deflected radially (i.e., across the grooves) to expose signal elements up to $15\ \mu\text{m}$ in length across the groove and 0.3 to $0.5\ \mu\text{m}$ deep. For the recording of frequency-modulated signals, the beam was swept across the groove with a triangular waveform applied to the deflection coils at a frequency much higher than that of the carrier and was blanked at the FM frequencies. The first good FM recordings were made at $1/200\text{th}$ of the playback rpm;

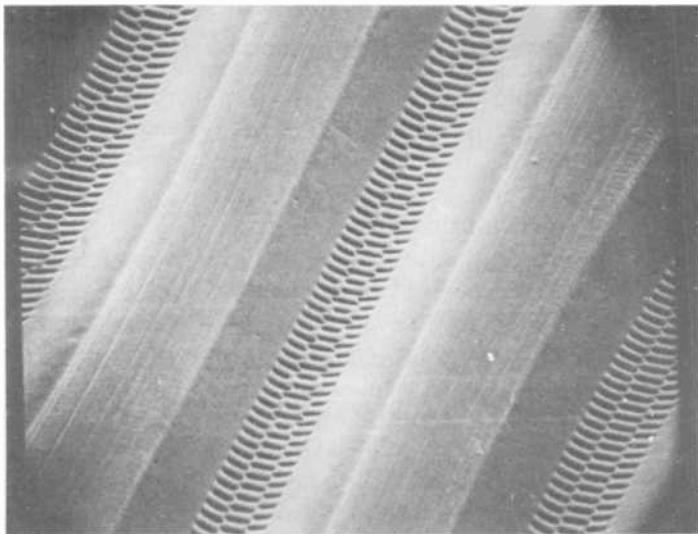

Fig. 6—Example of early SEM recording of a balanced AM-carrier-signal waveform.

by the time the capabilities of the swept beam reached their limit, recordings were being made at 1/9th of the playback rpm.

A major effort was made to develop the electron-beam recorder into a reliable production machine. An efficient oil-driven turntable capable of over 500 rpm rotation was developed, along with means to control its speed to synchronize accurately with the video input signal source speed. The beam improvements needed to reach real-time recording speed were obtained using a line source and a specially designed electron-optical column that imaged the source at reduced size (1/250) directly on the resist coating of the master being exposed. In the design of the column, a large electron-optical aperture was used to increase exposure density. Also, the column was designed to reduce drift of the focus, intensity, and position of the beam, as well as to improve reproducibility of control settings. The column parameters were adjusted to provide a final beam half-angle of about 2.5×10^{-2} rad, giving a depth of field of about $5 \mu\text{m}$. With a half-intensity line width of 1200 \AA and a source brightness of $5 \times 10^4 \text{ A/cm}^2\text{-str}$, a final image current of about $100 \text{ nA}/\mu\text{m}$ of image line length was produced. This was sufficient to deliver an exposure of up to about $3 \times 10^{-6} \text{ coulomb/cm}^2$ to the resist. A profile of the current density of the beam imaged from the line source is shown in Fig. 7. The cross section in the thin direction is nearly Gaussian. The half-intensity width depends on the final image current as shown in Fig. 8.

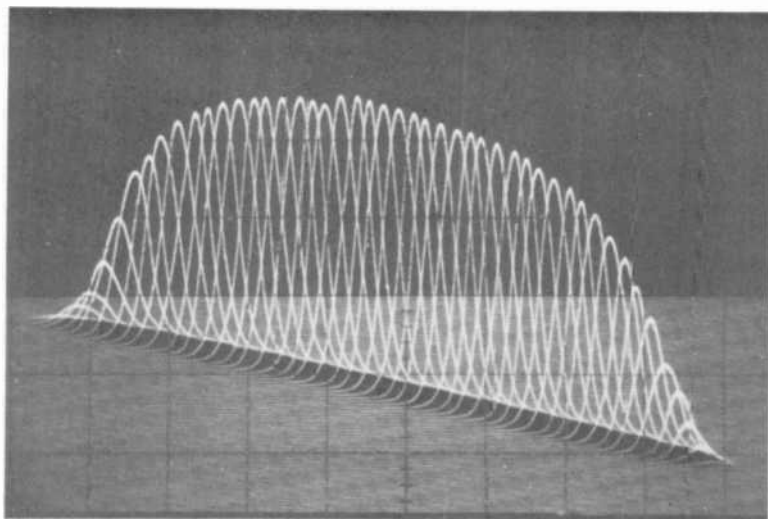

Fig. 7—Profile of beam from a line source.

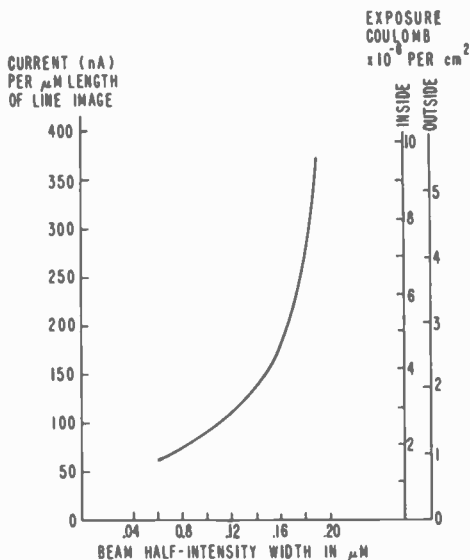

Fig. 8—Beam current per μm length of a line image versus line width at half-intensity level.

Since the substrate rotates at a constant angular velocity, the linear speed with which its coated surface moves under the beam decreases as the recording proceeds from the outside to the inside radius. To maintain constant exposure, the beam current is reduced in proportion to the radius using a weak nonrotating magnetic lens mounted immediately below the electron gun.

It was found that backscattered electron collection varied slightly but measurably with focus, being a minimum at best focus. This permitted initial focus adjustment to be made using the surface of the spinning disc itself. The end-of-recording beam focus was checked by recording a set of "through focus" bands with the focus control offset in steps for recording settings for both shorter and longer focal distances. After development of the resist, the band in best focus could be determined simply since it was the one seen with the most vivid diffraction color by visual inspection with a low-power optical microscope.

Due to imperfect flatness of the substrate or temperature-related dimensional changes, the distance from the final lens to the master surface inevitably varies during a recording. In order to maintain focus with $\pm 5 \mu\text{m}$, a capacitance probe was used to sense these variations and generate a correction current in an auxiliary dynamic focusing coil located within the final lens bore. The sensor was located at the same ra-

dus as the beam but offset to sense an area of the master surface before it passed under the beam. Inserting the proper time delay in the electronic chain between the sensor and the beam permitted good correction of fluctuations in distance encountered in rotation. With the above focus techniques the flatness of the master was no longer critical, and proper focus was achieved consistently over the entire master.

During the period when the recording rpm was less than 1/20th the playback rpm, the signal source was a slow-speed flying-spot 35-mm film scanner. When it was in the range of 1/20th to 1/5th real time (22.5 to 90 rpm), a video slow-down signal processor employing digital signal processing was used. For real-time recording a broadcast video tape recorder was used. In each case, buried-subcarrier encoding and video/sound FM signal processing apparatus was used.²

Prior to the actual VideoDisc master recording, the program material was edited and processed using another tape recorder and a new tape was recorded with the addition of desired fades, logos, etc., as well as adjustments for color balance, gamma, and other signal parameters. Such program preparation processes are necessary because the original source programs may be on a variety of media, often movie film, of variable quality; corrections must be made to put them into a form that results in good quality when they are presented on a TV screen. Program preparation procedures of this type are equally necessary for any type of disc or tape system for pre-recorded video programs. The practice is routinely used in preparation of film for television broadcast, and special equipment had been developed for this purpose. Included on this master tape at the time of its preparation is a Vertical Interval Reference Signal (VIRS) of the type that is standard in broadcast TV. This VIRS signal is processed so that its integrity is maintained through the buried subcarrier encoding and subsequent decoding (in the player). Tests have shown that TV receivers equipped to use the VIRS signal for automatic signal control purposes operate correctly on the VIRS signals derived from the RCA VideoDisc.

A binary-coded groove identification number signal is also recorded during the vertical blanking interval. It has proved to be extremely useful for locating a particular turn of the groove on a master, intermediate replica, or finished disc. This groove identification number can be recovered from the playback signal, or seen by inspection using either an optical microscope or scanning electron microscope. This has great value for quality control purposes as a technique for locating defects or flaws.

Two of the recorders were installed and used in a production environment for more than two years. Their reliability was constantly improved, reaching about 90% uptime for the one-half-hour-per-side disc

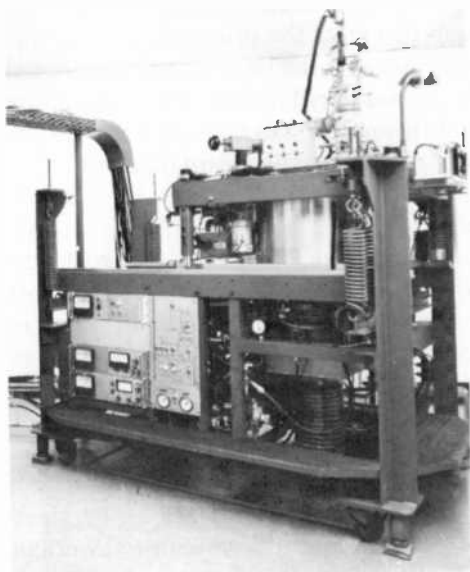

Fig. 9—Photograph of a model B electron-beam disc recorder.

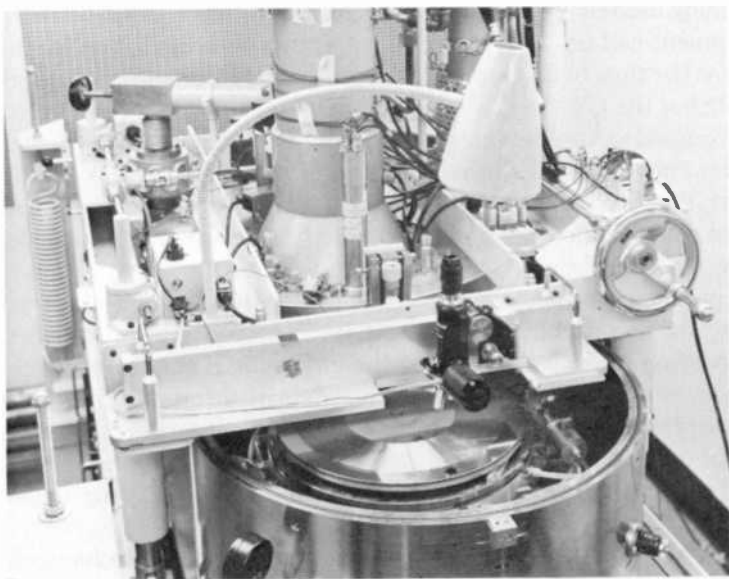

Fig. 10—Master disc loaded in recording chamber.

format. Only minor changes in the recorders were needed to adapt them to the one-hour-per-side, 9524-GPI master format.

Fig. 9 shows one such recorder (the control console and the signal equipment are not shown). Fig. 10 shows a master loaded in the recorder.

Improved Electron-Beam-Sensitive Materials

The need for reliable electron-beam recording of highly resolved relief patterns as small as $0.25 \mu\text{m}$ for the RCA VideoDisc required the development of a suitable high-resolution, positive-working electron-beam-sensitive medium with a sensitivity of 1- to 3-microcoulombs per cm^2 . Commercially available Shipley AZ-1350 photoresist, a two-component system including a resin and *ortho*-diazoketone sensitizers, was

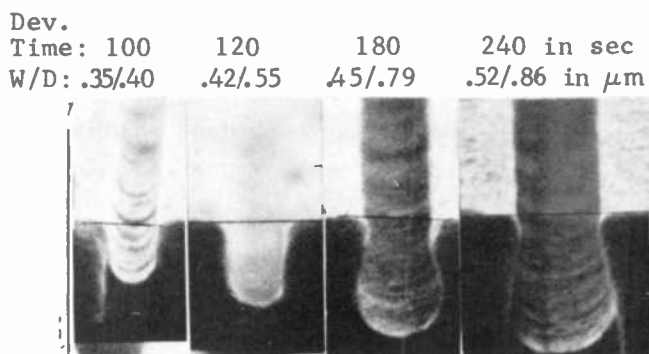

Fig. 11—Examples of profiles obtained with Mark II resist.

used for much of the earlier development work, but somewhat better and more uniform sensitivity was desired. Through the examination of a number of highly pure sensitizers, a two-component resist with enhanced electron-beam response was developed.⁶⁻⁸ During the development of the resist, the characteristics of sensitivity (the relative development rates of exposed and unexposed material), edge definition (the resolution of signal elements with good depth and narrow width), and surface smoothness were evaluated. The same characteristics were evaluated on small-sized samples and on full-sized masters for the new material and for different exposure and development conditions (see Figs. 11 and 12).

As indicated earlier, the measurements of signal elements produced with a special test signal were used to evaluate master exposure and

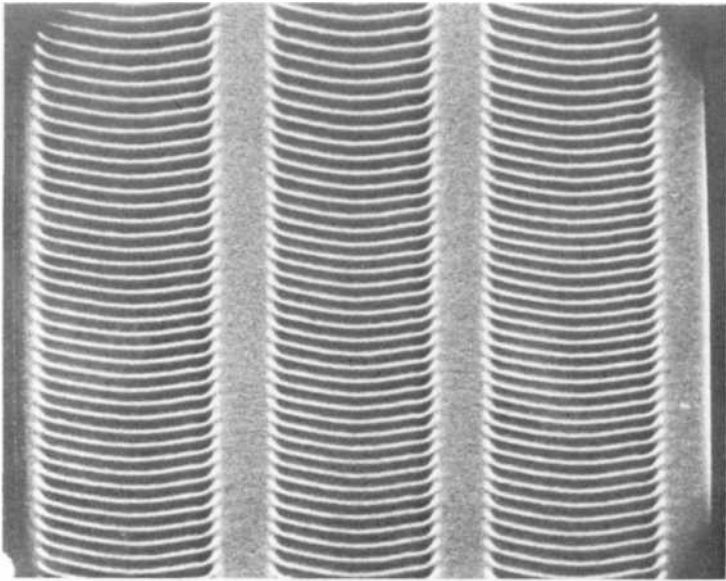

Fig. 12—SEM photo of 9-MHz signal elements recorded on a 1-9 MHz sweep test signal disc.

development results (refer again to Fig. 4). Fig. 13 shows how the ratio of 4.3 MHz amplitude to 6.3 MHz amplitude varied as a function of spatial λ on a test recording. The information was helpful in establishing the format of the one-hour-per-side disc.

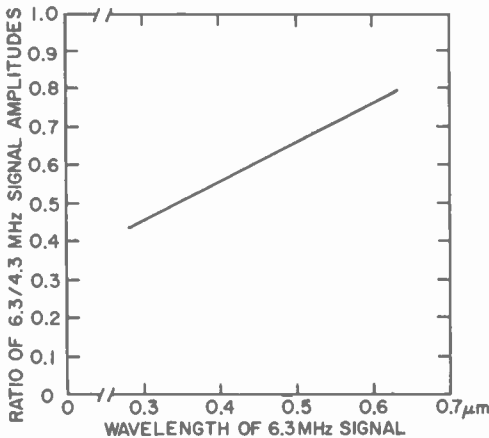

Fig. 13—Signal amplitude versus spatial wavelength.

In further work on materials for electron-beam disc recording, single-component polymeric materials were explored. The basic philosophy utilized was to search for polymers that would have a low probability of cross-linking, a high probability of chain scission, and an available molecular mechanism for a chain "unzipping" process leading to the production, in high yield, of low-molecular-weight fragments. It was found that films of certain copolymers of SO_2 and olefins had high sensitivity and low "track drop."⁹

3. Optical Mastering

Real time optical mastering of RCA VideoDiscs also was demonstrated successfully. The principal technical difficulties associated with the optical recording of high-quality masters in the 450 rpm RCA VideoDisc format were optical resolution to make $0.25 \mu\text{m}$ signal elements and undesired optical standing-wave patterns caused by reflections from the bottom of the grooves.

In early work, optical exposure from incoherent light sources was used to make test patterns on small samples and on the first full-sized discs. A closed ring of $0.5\text{-}\mu\text{m}$ signal elements was made by exposing the surface of a relatively thick layer of Shipley AZ-1350 photoresist at 1/2000 play speed to the image of a chopped line-shaped high-pressure mercury-vapor light source made by using a high quality microscope optical column and a final lens with a numerical aperture of 0.95. The surface was replicated by the metalization, plating, and separation technique previously described. The resulting master was used as a stamper to produce test discs with a closed ring of $1\text{-}\mu\text{m}$ -wavelength signal elements for early pickup development work.

Though useful for experimental pattern making, exposure with non-coherent light sources was much too slow for making long-play recordings. A coherent light source, such as the He-Cd laser, offered the increased beam intensity and, thus, the recording speed needed to make optical recording attractive. Preliminary recordings were made by adding an electro-optical modulator to an He-Cd optical reader of the type described in the paper on optical techniques⁵ in this issue of *RCA Review* and by using sag-coated substrates with trapezoidal groove shape of the same type being used for electron-beam recording. It was found that by careful attention to the optical system, the development of reliable focus techniques, and meticulous care in the development process, patterns of the necessary signal element geometry could be produced.

Focus was maintained by the use of an air-puck servo system that was monitored by a capacitance sensor. The output of this sensor was used for making coarse adjustments that kept the servo system within its

operating range. Accurate determination of focus could be made by observing the frequency spectrum of the beam reflected back from the master surface. The relative amount of high-frequency content, due to resolution of micro-roughness of the master surface, indicated the condition of the spot focus. A colinear beam from an He-Ne laser was found to be well suited for tracking.

To maintain uniform exposure as a function of the radius while recording, the recording beam was appropriately attenuated by gradual adjustment of a variable-density filter through which it passed. A proprietary material developed for electron-beam recording was used for

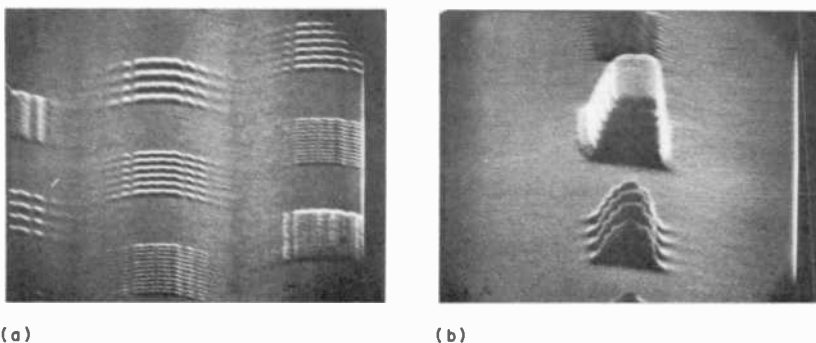

Fig. 14—Examples of the effect of optical standing waves due to reflection from the substrate: (a) segmented signal elements and (b) layered signal elements.

optical recording because of its uniformity and resolution properties. Because the high intensity of exposure resulted in short development times, the remaining surface was less eroded, i.e., smoother than was the case for electron-beam-recorded master surfaces. The “ Δ track drop” of Fig. 4 was also low. However, as a result of reflections from the side-walls and bottom of the trapezoidal groove, the beam tracking signal was ill-defined, and the complex standing wave exposure caused the signal elements to be divided into a series of segments that formed a chain across the groove. Figs. 14a and 14b illustrate how standing waves in a relatively thick coating are visible in the surface of the signal elements after development.

Significant improvement in signal geometry control was achieved by recording onto substrates that had cusp-shaped grooves and that were conformally coated with an approximately $0.1\text{-}\mu\text{m}$ -thick layer of photoresist (see Fig. 15). With this groove geometry, reliable tracking signals were obtained and the standing-wave pattern, coupled with the well-controlled photoresist depth, produced an unusual development char-

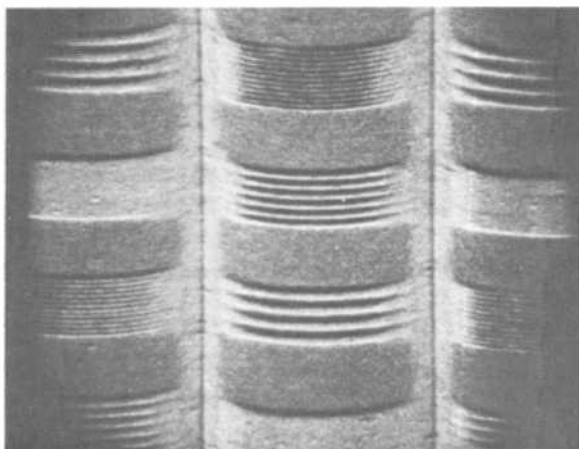

Fig. 15—Example of how use of conformal coating of specified thickness and cusped grooves eliminates segments (compare with 14a).

acteristic that resulted in a flat modulation transfer characteristic over a wider frequency range than one would predict based on standard optical-resolution considerations (see Fig. 16).

An interesting mode of optical recording that made use of the linear modulation capability of laser beams was also explored. In this mode the video and audio carrier signals are linearly added and the composite signal is electronically pre-emphasized to compensate for the modulation transfer function roll-off of the recording beam. The maximum compensation is achievable when the grooves are recorded simultaneously with the signals. These recordings are made onto smooth (ungrooved) substrates coated with a $3\text{-}\mu\text{m}$ -thick photoresist layer, and enough exposure is maintained to expose the groove at the same time the signal is being exposed. This resist thickness is sufficient to substantially eliminate observable interference effects.

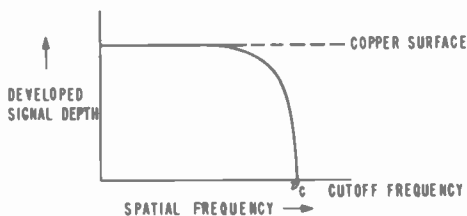

Fig. 16—MTF of thin uniform coating of optimum λ .

4. Electromechanical Mastering

The key elements of an electromechanical recorder (EMR) are shown in Fig. 17. A smoothly turning precision turntable is accurately locked to the signal source by a tachometer and speed servosystem (not shown). A cutterhead is mounted on a sturdy arm with a translation mechanism that moves the cutterhead smoothly a distance of one inch every 9,524 turns. (Due to shrinkage in master replication and in disc-molding steps, the final disc has a slightly different number, nominally 9,541 turns per

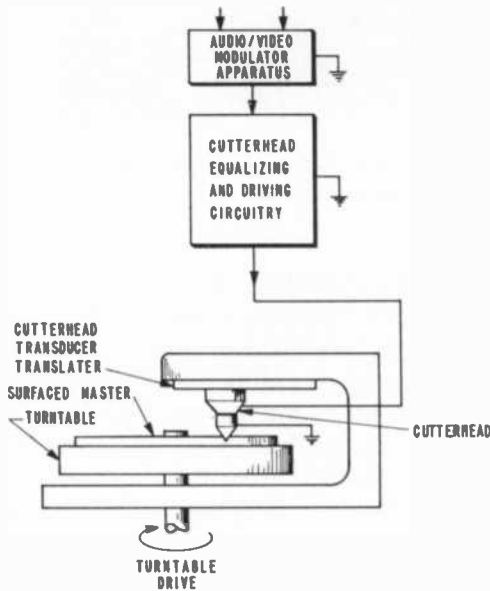

Fig. 17—Simplified schematic diagram of an electromechanical recorder.

inch.) On the turntable is a flat metal disc substrate covered by a layer of material that can be smoothly cut by sharp diamond cutting tools or styli. Before recording, the top surface of the material is carefully machined to be flat. The sharp diamond recording stylus has a tip-face shape that corresponds to the desired cross-sectional shape of the finished groove, and cuts the groove at the same time it is recording the signal. In operation, the depth of the cut is determined by the position of the cutterhead support relative to the machined surface of the recording material. The cut is deeper than the groove, however, so groove depth is controlled by the shape of the recording stylus tip and the amount it has been translated between turns. Means are provided to

remove the chip during the cutting. The amplitude of the signal recorded is determined by the high-frequency motion imparted to the tip. Signals to drive the cutterhead are provided through an equalizing circuit, which is necessary to compensate for the way the amplitude and phase of the high-frequency cutting varies with frequency.

In the overall program of development of the RCA VideoDisc system, electromechanical recording, like optical recording, was used at an early stage to make a small number of very useful system-test disc masters. The chief problems at that time were (1) low recording speed capability, which was limited by frequency response of the available cutterheads, (2) inadequate surface smoothness, which was limited by the characteristics of the available recording material, and (3) lack of uniformity of groove depth and pitch, which were limited both by the characteristics of the material and by the precision of the recorder mechanisms.

Initially, a coating of lacquer on a flat disc substrate was the recording medium. It was cut with a heated stylus. Both commercially available and laboratory-prepared lacquer-coated metal substrates were used in attempts to cut the smoothest possible surface finish and a minimum of low-frequency undulations in the groove. The short wavelengths of video recording make it difficult to employ a cutter tip with burnishing facets as used to make smoother surfaces in audio recordings. Fig. 18 shows the surface smoothness achieved, which was not as good as that obtained by electron-beam recordings of the same era. Later, however, it was found that with a sharp diamond stylus very smooth cuts could be made in certain metals.¹⁰ Furthermore, the stylus did not need to be heated, permitting use of a shorter shank on the cutting tip, which reduced its mass. Fig. 19 shows the surface quality achieved by cutting in electroplated copper.

After a short period during which audio cutterheads were used, development of special video cutterheads began, using piezoelectric rather than magnetic transducers. The basic construction of present cutterheads is shown in Fig. 20. A piezoelectric transducer, typically made from Vernitron PZT-8* material, supports a diamond cutter tip that is bonded to it with an epoxy cement. In turn the PZT element is bonded to a steel element, again with epoxy or a low-temperature metal alloy. The two, loaded by the diamond cutter, form a mechanically resonant unit that is damped by a layer of Kapton† material and Viscoloid** cement used between the steel element and the support, and to some extent

* Registered trade name of the Vernitron Piezoelectric Div., Bedford, Ohio.

† Registered trade name of E. I. DuPont deNemours and Co., Inc.

** Registered trade name of General Electric Co.

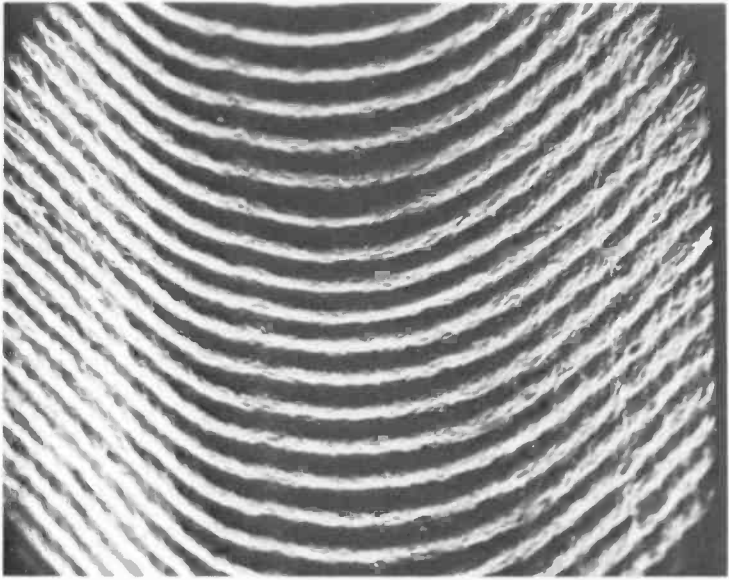

Fig. 18—Surface quality of signal mechanically cut in lacquer. The width of the signal groove shown here is $12\ \mu\text{m}$.

by losses in the bonding materials on both faces of the PZT element. The PZT element and the metal element have dimensions that are tapered and so chosen that the main resonance is broadened and the response is free of undesired resonance modes over a relatively wide frequency range. One of the functions of the steel element is to present, at the higher

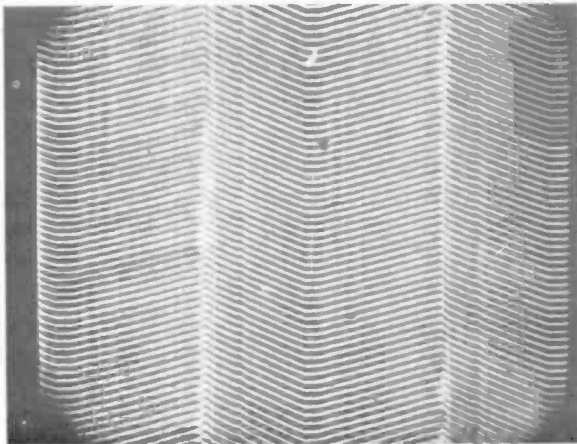

Fig. 19—Surface quality of a signal mechanically cut in copper. The full-width groove shown in the center of the photo is $4\ \mu\text{m}$ wide.

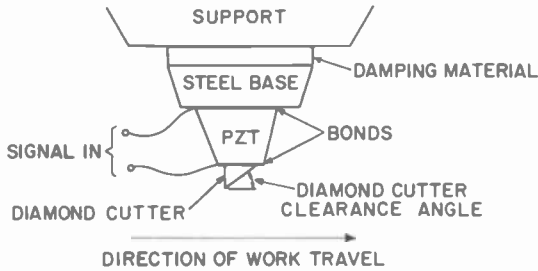

Fig. 20—Schematic of EM cutterhead.

driving frequencies, a high mechanical impedance to the steel-element side of the PZT, so a given motion of the other side, upon which the diamond cutter is mounted, can be achieved at a lower driving voltage.

For real-time recording, the thickness of the PZT element and the steel element are each about 0.1 mm, and their widths and lengths somewhat greater. The diamond tip, which usually has been purchased, is made even smaller; typically its greatest tip-to-base dimension is 0.1 mm. The back clearance angle of 28–35° is needed, so the tip-to-base dimension tapers to zero. Even for this small diamond tip mass, the dynamic stress on the bond between it and the PZT element is in excess of 1,000/pounds per square inch for $\approx 800 \text{ \AA}$ peak-to-peak motion at 5 MHz. Stresses in the PZT/steel bond are also high; if a bond fails in use, it is as likely to be the PZT/steel bond as the PZT/diamond bond.

For uniformity of frequency response, parts are made precisely and special fixtures are used in assembly. The units are bench tested for mechanical impedance and for motion characteristics, both before and after the diamond tip is assembled. Motion characteristics of the partially assembled units can be checked using variable-capacitance sensing techniques (e.g., the 915-MHz capacitance-sensing circuitry of a player pickup arm has been used for this purpose). The most powerful motion-analysis instrument, however, is the laser interferometer described by Gorog.⁵ For example, it can be used to measure the amount of motion of the tip of the diamond cutter; the amount of motion tangential to the groove (orthogonal to the desired cutting motion) must be kept low to preserve the otherwise inherent linearity of the cutterhead.

In general, the cutterhead sensitivity at frequencies well below resonance is independent of the thickness of the piezoelectric elements used, i.e., the displacement is proportional to driving voltage. It is desirable to limit the voltage to avoid breakdown due to heating and to excessive field intensity. To achieve this, the cutterhead is so constructed that its

response characteristic matches that of the energy distribution of the applied signal components, i.e., its response is peaked in the region of 5.5 MHz for real-time recording. An equalizer circuit is used to provide a relatively flat response over the full bandwidth occupied by significant components of the encoded signal. Operated in this manner, the equalizing circuit attenuates the energy level of signal components lying in the region where most of the energy of the encoded signal occurs, thereby protecting the cutterhead from application of excessive electric fields. Distortion is reduced by this method of operation compared to a method where the cutterhead resonance is located above the video spectrum, since the peak voltages applied to the power amplifier are smaller and the response of the cutterhead is reduced at harmonic frequencies that are above its resonance frequency.¹¹

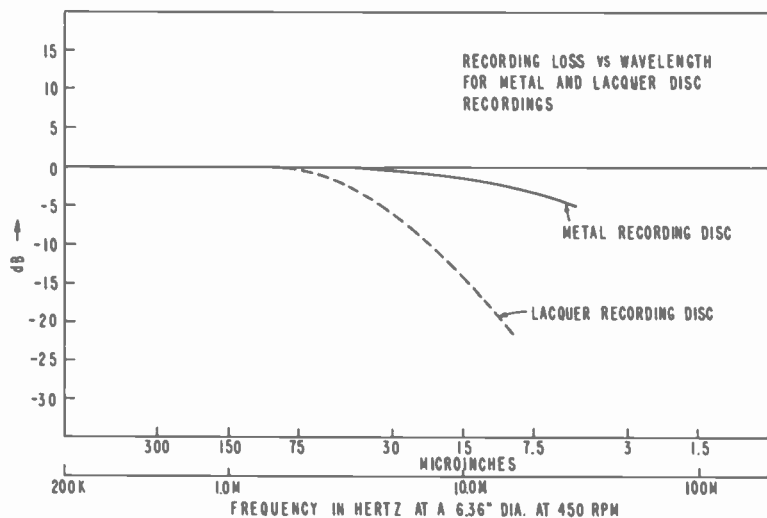

Fig. 21—Curve of EM recording amplitude versus wavelength at 5 MHz for lacquer and for copper showing less recording loss occurs for copper.

With cutterheads able to operate at high frequencies, a further advantage of using a metal as the recording medium was realized. For lacquer, the resulting recorded amplitude at the wavelengths and frequencies used in VideoDisc recordings is substantially less than the cutter motion; for the metal there is little loss (see Fig. 21). This simplifies equalization and it reduces the voltage required to drive the cutter.

Since no development process is required, EM masters can be read out as soon as they are cut. Optical readers⁵ are well-suited for this

purpose. They can be used to check quickly the equalization of the cutterhead, or can be used as monitors during the recording.

The replication process from the metal original masters is simply one of electroplating a layer of nickel onto the original master and separating it to form negative-metal-master copies that then are used to make molds

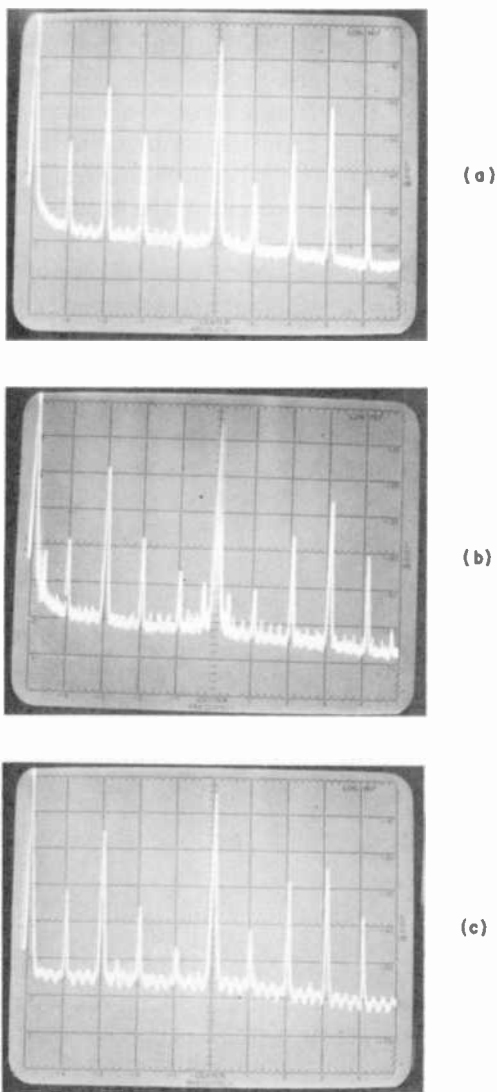

Fig. 22—Spectrum analyzer traces: (a) electron-beam, (b) optical, and (c) electromechanical discs.

and stampers in the usual fan-out process. Multiple metal masters can be made from the original master, so a large number of stampers and pressed discs can be made from a single recording.

For electromechanical recording, as well as for optical and electron-beam recording, it has been the practice to record, in addition to other inside-radius test signals, a short band of 5 MHz signal, frequency modulated ± 0.5 MHz at a 3-MHz rate. Measurements taken in the playback of this signal are used to evaluate certain qualities of the recording, such as the 5-MHz carrier-to-noise ratio. Fig. 22a shows a spectrum analyzer response taken from playback of such a test signal on discs derived from an electromechanical recording. Similar responses for discs made from optical and electron-beam recordings are shown in Figs. 22b and 22c, respectively. The similarity of the results for the three different methods of mastering can be clearly seen.

In terms of master defects that would affect tracking of the stylus during playback, the electromechanical method of mastering was clearly superior to the other methods. The cleanly cut signal and grooves in the copper are almost completely free of any upward protuberances or significant holes. Also, the grooves can be made significantly deeper than those made by the other methods that use a resist coated on a grooved substrate. These two factors, few defects and deep grooves, are important in achieving player performance in which a locked or skipped groove is an infrequent occurrence.

5. Conclusions

A comparison of the mastering methods for RCA VideoDiscs shows that all are capable of making good masters, but electromechanical mastering is to be preferred, for reasons that include the following:

- High yield of defect-free masters.
- Capability of the basic cutting process to cut signals with short spatial wavelength.
- Least demanding of environment cleanliness in the mastering area.
- Smooth surfaces, resulting in high signal-to-noise ratios.
- Simple recording and processing facility needs.
- Immediate readout possible from original master during recording.
- Multiple copies can be made from a single original master.
- Deep grooves, which help stylus tracking during playback.
- Inherently linear recording.
- The groove is cut at the same time the recording is made, simplifying the mastering procedure.

Acknowledgments

Mastering for the RCA VideoDisc system was developed during a period extending more than a decade, and involved many individuals for significant parts of that period. Early pioneers in the area included O. E. Dow, R. E. Flory, R. W. Jebens, and A. Streib, assisted by A. W. Buzgo, E. A. James, C. R. Morris and others. Shortly afterward L. B. Johnston, M. Kaplan, D. I. Harris, W. E. Kozieliec, W. H. Morewood, and R. C. Palmer joined the effort, followed by L. A. Barton, J. B. Halter, D. L. Matthies, S. M. Zollers, and others. In time, teams were established at Princeton and at Indianapolis.

Processing teams headed by L. P. Fox and G. John included, in addition to some of the people already mentioned, H. G. Scheible, A. Arena, J. Levin, D. Fairbanks, H. J. Muller, R. Mehalso, A. Sabo, R. Nosker, S. Seffren, L. DiMarco, E. Holub, T. Rosenkranz, P. Valembouis, and H. Wielecki at Princeton and E. Jackson, D. Woodford, D. Morris, S. Gaskins, J. Harmon, G. Wright, D. Horan, and E. Duke at Indianapolis.

D. L. Ross led teams that provided improved electron-beam- and laser-beam-sensitive materials, including L. A. Barton, M. Kaplan, E. S. Poliniak, R. J. Himics, D. Meyerhofer, E. Gavalchin, A. W. Levine, L. Fech, N. V. Desai, E. B. Davidson, C. Hu, F. E. Jackson, D. M. Gavrilovic, E. F. Pasierb, D. L. Matthies, and C. S. Oh.

The electron-beam recording teams were headed by J. H. Reisner and G. John and included K. Bahrs, W. Bruce, E. Campbell, C. Corson, R. Demers, D. Jose, W. Marz, W. Lees, W. McMillan, C. Whybark, R. Simms, E. Simshauser, G. Riddle, R. Sanford, L. Lin, J. Guarracini, J. Valentine, and J. Valachovic at Princeton and J. Seward, N. Cundiff, D. Stapert, M. Hampton, J. Gold, S. Rowe, and T. Horner at Indianapolis.

The optical mastering team was headed by I. Gorog and included A. Firester, J. Russell, C. Carroll, M. Heller, and Ron Roach, all at Princeton.

Very dedicated pioneering and perservering work by J. B. Halter resulted in the EM cutterhead, while R. Castle, J. Halter, and G. John developed the EM recorder. C. Knottenbelt provided the diamond tip expertise. They were ably assisted by D. Dunham, J. Warner, D. Honer, J. Gold, and M. Pradervand. More recently H. Wharton has joined the Indianapolis EM recording team, while some of the Princeton EBDR mastering team, plus G. Alphonse, J. Bleazey, K. Etzold, N. Foster, H. Moss, M. A. Leedom, and others are focusing on improved EM cutterheads.

J. E. Lang headed all of the Indianapolis mastering work, and through his leadership brought about the development of EM recording to a state of acceptance.

J. K. Clemens and members of his signal system team, especially R. Drake and M. Ross, contributed by supplying signals to be recorded. H. Wharton, S. Aisenbrey, J. James, R. Indan, and B. Jansen supplied signals in Indianapolis.

J. J. Brandinger and an RCA, Moorestown, group developed the video slow-down processing equipment used to supply signals while the gap between 1/20th and full real-time recording speed was being bridged.

There was very substantial support by a number of people, headed by C. R. Kevit, in the mechanical construction of recorders, and by other people in technology support areas under the direction of H. O. Hook and R. S. Shankweiler, and later M. A. Leedom.

Supervisory and management people, over the long period, continuously provided positive incentives, understanding, and encouragement.

To K. Spencer and S. Zollers the author owes special thanks for help in the preparation of this article.

References:

- ¹ "The RCA 'SelectaVision' VideoDisc System," D. S. McCoy, *RCA Review*, 39, No. 1, p. 7, March 1978 (this issue).
- ² "Capacitive Pickup and the Buried-Subcarrier Encoding System for the RCA VideoDisc," J. K. Clemens, *RCA Review*, 39, No. 1, p. 33, March 1978 (this issue).
- ³ "The Evolution of the RCA 'SelectaVision' VideoDisc System," E. O. Keizer and D. S. McCoy, *RCA Review*, 39, No. 1, p. 14, March 1978 (this issue).
- ⁴ "Material and Process Development for VideoDisc Replication," R. J. Ryan, *RCA Review*, 39, No. 1, p. 87, March 1978 (this issue).
- ⁵ "Optic Techniques Developed for the RCA VideoDisc," I. Gorog, *RCA Review*, 39, No. 1, p. 162, March 1978 (this issue).
- ⁶ "Electron Beam Recording Process," D. L. Ross and L. A. Barton, U.S. Patent No. 3,852,771.
- ⁷ "Electron Beam Recording Article with O-Quinone Diazide Compound," D. L. Ross and L. A. Barton, U.S. Patent No. 4,024,000.
- ⁸ "Method of Purifying 2,4-Bis(6-Diazo-5,6-Dihydro-5-oxo-1-Naphthalenesulfonyloxy Benzophenone)," D. L. Ross and L. A. Barton, U.S. Patent No. 4,024,122.
- ⁹ "Electron Beam Recordia Media," M. Kaplan and E. B. Davidson, U.S. Patent No. 3,893,127.
- ¹⁰ "Method and Apparatus for Electromechanical Recording of Short Wavelength Modulation in a Metal Master," J. B. Halter, U.S. Patent No. 4,044,379, Aug. 23, 1977.
- ¹¹ "Wideband Electromechanical Recording System," J. B. Halter, U.S. Patent No. 4,060,831, Nov. 29, 1977.

Material and Process Development for VideoDisc Replication

R. J. Ryan

RCA SelectaVision, Indianapolis, In.

Abstract—This article describes the material and process requirements for VideoDisc replication. Considerations for compound formulation and processing and disc molding are discussed. The development of materials is reviewed from the initial work done with audio-record compounds to VideoDisc compounds for compression and automatic injection molding. The characteristics of various compound resins and additives are discussed together with their effect on melt properties and molded disc surface quality. Development of conductive compounds is also reviewed, and their characteristics are compared with those of nonconductive materials.

1. Introduction

The requirements of materials and processes for the replication of VideoDiscs are dictated by the extremely fine dimensions of the recorded signal elements and by the playback dynamics at high rpm. The capacitive VideoDisc operating at 5 MHz at 450 rpm extends down to wavelengths of $0.5 \mu\text{m}$ at the inside diameter. In comparison, stereo audio-disc frequencies are typically in the order of 10 kHz at 33 rpm, and signal element wavelengths of $6 \mu\text{m}$. Groove widths, while measuring typically $50\text{--}60 \mu\text{m}$ for audio discs, are $2.7 \mu\text{m}$ for the VideoDisc. In addition, groove depth of the VideoDisc is in the order of 4000 \AA with signal element amplitudes in a range of $500\text{--}1000 \text{ \AA}$. The relative differences in surface dimensions of video and audio discs are readily seen in the SEM photographs in Fig. 1. Full details of the capacitive disc system are described by McCoy.¹

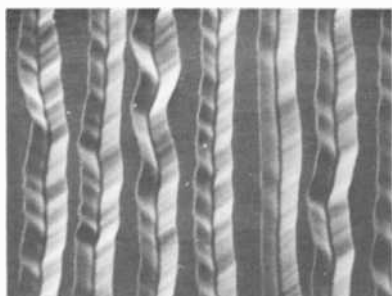

(a) STEREO DISC AT 200× MAG.

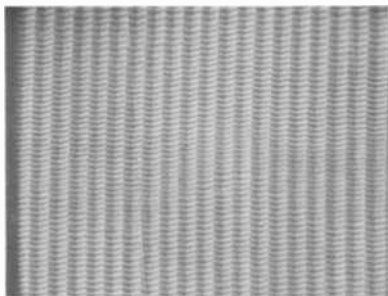

(b) EM VIDEODISC AT 2000× MAG.

Fig. 1—SEM comparison of stereo audio disc and VideoDisc surfaces.

When one considers the fine dimensions of the VideoDisc noted above, it is easy to understand that extreme demands are placed on both the materials and processes used for disc replication. Playback dynamics and environmental requirements must also be considered to ensure good performance over the projected use and lifetime of the disc. Good stylus tracking at high rpm requires tighter specifications for disc surface flatness and a minimizing of acceleration effects, which means more stringent control of as-molded warp and physical surface defects. Environmental considerations are essentially those required for normal audio-disc performance. The higher surface quality noted above, however, requires improvement in material and process operating characteristics over those typically used in audio-disc manufacturing.

The VideoDisc replication system evolved from audio-record technology, a review of which was presented recently by J. Ruda.⁴ Record masters are mechanically cut into a lacquer-coated substrate and electroformed to produce nickel molding stampers. Records are then compression molded using a high-flow polyvinyl chloride compound. Low-temperature acetate copolymers and manual or semiautomatic compression molding are used almost universally in audio-disc production. These materials and processes do not satisfy VideoDisc requirements, however, mainly due to the much higher information density and greater dynamic effects in playback at a higher rotational speed. Rotating at $33\frac{1}{3}$ rpm, audio records can be tracked even when warped by 60 mils (1.5 mm) or more, a physical distortion which can be seen by the user. The VideoDisc, with its rotational speed of 450 rpm and much shallower grooves, may experience tracking difficulties when warped by as little as 20 mils (0.5 mm), which may be difficult to detect by eye. To compensate for these more stringent flatness requirements, higher quality and higher temperature materials are required along with improved process control.

The overall process flow schedule used in VideoDisc replication is outlined in Fig. 2. A master substrate is first recorded with the program information. This master is then replicated into multiple thin metal parts in an electroforming process, commonly called the matrix stage. Metal stampers from matrix are positioned on the mold halves in the press and discs molded to complete the replication process. A final process, such as addition of a lubricant coating, produces the finished disc.

The important material and process parameters in the compounding, matrix and molding stages that are required for VideoDisc replication are presented in this paper. First, we explain considerations applicable to nonconductive discs. Additional considerations for recently developed conductive discs are then discussed. Details of mastering and disc coating technology for the capacitive VideoDisc system are reviewed in separate papers by E. O. Keizer² and D. L. Ross³ in this issue of *RCA Review*.

2. VideoDisc Materials and Formulation Development

To fulfill the requirements for VideoDisc applications, the materials used in disc processing must exhibit three main characteristics: (1) a uniform homogeneous composition, (2) good melt flow with controlled rheology and process stability, and (3) dimensional and environmental stability of the molded disc.

The first two requirements imply a good process-control capability in practical manufacturing equipment, namely, good material blending in the compounding stage, controlled melt flow, and good thermal stability during molding. The third is necessary for good disc life under the environmental conditions encountered in normal use. Polyvinyl chloride-acetate copolymer compounds satisfy these requirements for audio discs, but considerable modification of these compound systems is necessary to meet VideoDisc needs.

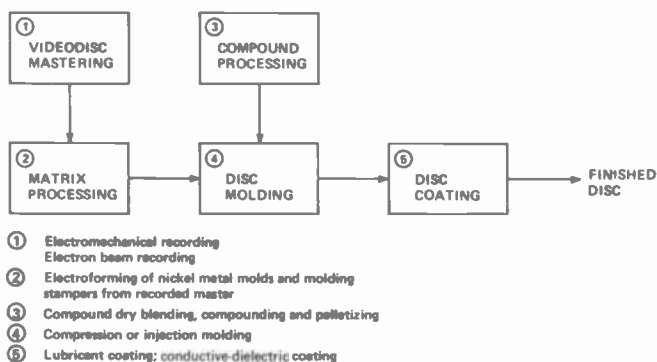

Fig. 2—Process sequence for VideoDisc replication.

PVC compound technology is an established part of the plastics industry and is well documented in technical literature and industrial publications.⁵ Compositions consist generally of three main ingredients: (1) a base resin homopolymer, copolymer, or a mixture of the two, (2) a thermal stabilizer to tie up generated HCl and prevent degradation of the polymer structure, and (3) a process lubricant to aid in fusion of the resin and to reduce friction against process equipment surfaces. Other additives may include processing aids to control or enhance melt blending or flow and colorants to impart desired surface appearance. The choice of resin and additives is determined by the molded part and process requirements and will vary considerably according to application, e.g., injection-molded pipe fittings compared to a clear blow molded bottle. In VideoDisc compounds all components must be considered individually and in combination to establish the effect on disc quality and performance.

Initial work in the capacitive VideoDisc development up to 1973 was done with standard audio type PVC-acetate base compounds. These consisted of 98% PVC-acetate resin, 1.5% metal stabilizer-lubricant such as barium cadmium stearate, and 0.5% carbon pigment. These early compositions functioned adequately in replication of VideoDisc surfaces by compression molding; however, they exhibited degraded performance in high temperature and high humidity environments. In later work, newer audio compounds containing liquid tin stabilizers, small amounts of an epoxidized oil, an antistatic agent, and a calcium stearate lubricant were used. These produced a lower noise surface than the previous compounds. In long press runs, however, antistatic agents were found to attack the nickel stamper and cause some degradation of high frequency disc performance. The compound composition was improved in 1973 by deletion of the antistatic agent and epoxidized oil and the replacement of carbon black by an oil soluble dye. This formulation performed well in compression molding, producing discs of high surface quality. The major problems with this composition were sensitivity to high humidity, degradation of coated disc performance, and a low heat-distortion temperature. These problems were attributed to the acetate copolymer base resin. The calcium stearate lubricant was also found to increase the sensitivity to moisture. Further development led to the replacement of the acetate copolymer by a low-molecular-weight PVC homopolymer and of calcium stearate by an ester wax lubricant, which resulted in acceptable humidity and thermal disc performance. General compositional details of the above compounds are included in Table 1.

Table 1 — VideoDisc-Compound Formulation Development

	Typical Simple Audio Compound	Improved Audio Compound	Early Modified VideoDisc Compound 3-S	Simplified Improved VideoDisc Compound 18-U	Higher Temperature Improved Quality VideoDisc Compound 27-S	High Quality High Temperature Injection Molding VideoDisc Compound 53-T
PVC-Ac Copolymer (Solvent Resin)	88.0	85.75	96.25	96.0	—	—
PVC-Ac Copolymer (Suspension Resin)	10.0	10.0	—	—	—	—
PVC Homopolymer	—	—	—	—	96.6	—
PVC-Propylene Copolymer	—	—	—	—	—	95.25
Carbon Pigment	0.5	0.5	—	—	—	—
Organic Dye Pigment	—	—	—	—	—	—
BaCd Stearate (Stabilizer-Lubricant)	1.5	—	0.0025	0.1	0.1	—
Liquid Organo Tin (Stabilizer)	—	—	—	—	—	—
Solid Organo Tin (Stabilizer)	—	2.0	2.0	3.0	3.0	2.0
Epoxidized Oil	—	—	—	—	—	—
Antistat Material	—	1.0	1.0	—	—	—
Calcium Stearate (Lubricant)	—	1.0	1.0	—	—	—
Monton Ester Wax (Lubricant)	—	0.25	0.25	0.9	—	—
Internal Ester Wax (Lubricant)	—	—	—	—	0.3	0.5
External Ester Wax (Lubricant)	—	—	—	—	—	0.25
Acrylic Process Aid	—	—	—	—	—	2.0

2.1 Base Resin Systems

The major available PVC base resin systems consist of the PVC homopolymers of varying molecular weight, PVC-acetate copolymers of varying acetate content and molecular weight, and, to a lesser extent, copolymers based on propylene and ethylene. In rigid PVC base formulations, the resin constituent comprises 95 to 98% by weight of the total composition of the compound and is the major factor determining the melt flow in a given process and the resultant disc heat-distortion characteristics.

Melt flow at a given temperature is dependent on the molecular weight of the resin and resin composition. The presence of the acetate or propylene groups in the polymer chain of the copolymer systems enhances mobility of the resin molecules. This produces higher melt flow for an equivalent molecular weight and temperature than the corresponding homopolymer system. In the case of the acetate copolymer, the higher flow rate translates to faster compression molding cycles at the steam temperatures typically available in the industry, hence their general use in the record industry.

Melt flow is also a function of the percent copolymer group in the resin. Typical acetate content of audio record resins is around 14%. Rheology data for various resin base compounds taken on an Instron Capillary Rheometer is presented in Figs. 3 and 4. Apparent viscosity as a function of temperature, which is plotted in Fig. 4, clearly indicates the viscosity differences among the resins.

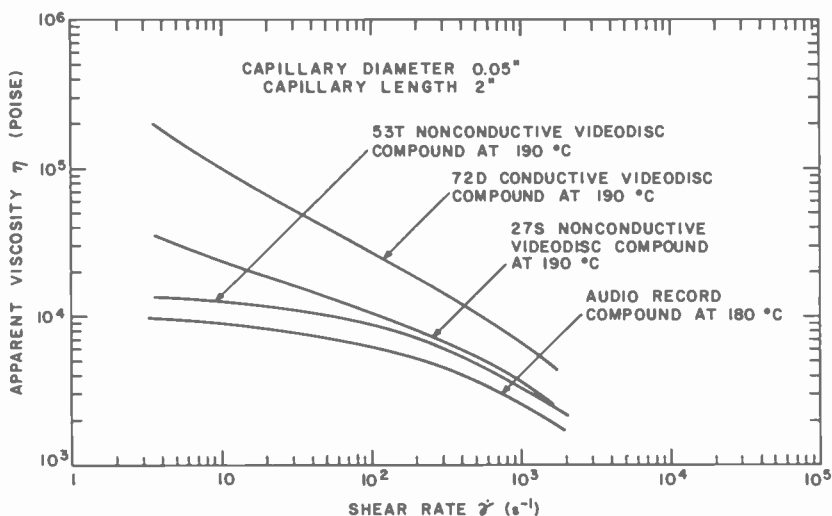

Fig. 3—Melt-flow characteristics of various disc compounds.

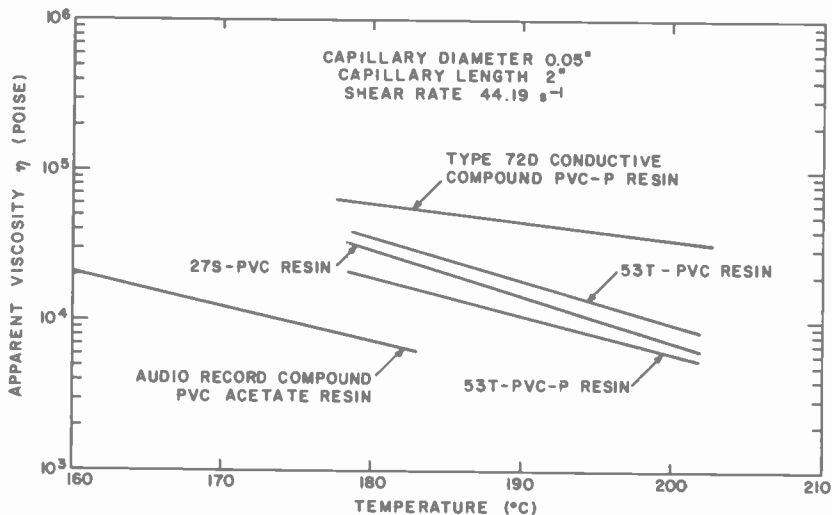

Fig. 4—Melt viscosity versus temperature characteristics of various compounds.

The presence of the copolymer group, while improving melt flow, can have an adverse affect on other properties. Compound heat stability for a given stabilizer system at a given temperature is lower for an acetate base resin in comparison to a homopolymer compound and higher for a propylene resin. The heat-distortion characteristics of the molded disc are directly dependent on the resin composition. The copolymer group leads to a lowering of the glass transition temperature that is proportional to the percentage of copolymer in the resin and to a resultant lowering of heat-distortion characteristics of a molded part. Discs made from acetate copolymer formulations listed in Table 1 show adverse static sag warp of greater than 0.020 inch (.05 cm) at temperatures above 105°F (40.5°C) when tested for 48 hours on a fixture where the playing area of the disc is unsupported. Discs made from a corresponding homopolymer composition or from a propylene resin with less than 6% propylene content show no adverse warp at temperatures up to 130°F (54.4°C) for the 48 hour test.

Moisture sensitivity is also affected by the resin system. Acetate groups and residual vinyl alcohol groups present in acetate copolymers make the resin moisture sensitive in comparison to a homopolymer or propylene copolymer. VideoDiscs of the coated metal-dielectric layer type made with acetate copolymers show degraded performance with much greater incidence of signal loss when tested at humidities above 85%. Homopolymer or propylene copolymer discs show little to no affect.

The problems noted above with audio record type acetate-copolymer

base compounds forced the development of VideoDisc compounds with alternative resin systems, namely, the low molecular homopolymer and propylene copolymer materials.

Other important properties of base resins that must be controlled for use in VideoDisc compound processing include molecular weight and molecular weight distribution, particle size distribution, and percent residual volatile material. Experience has shown that these properties can be controlled adequately in cooperation with resin manufacturers.

2.2 Compound Additives

The general considerations for the selection of additives for use in VideoDisc compounds are adequate performance of the specific additive, good thermal and process stability, and good environmental and life performance in the molded disc. The second consideration implies good compatibility of the additive material within the compound matrix under the thermal and shear stresses experienced during compound processing and disc molding. In this regard, choice of additive materials based on available product information and existing laboratory tests is a difficult task. In most cases, disc molding is the only true measure of ultimate performance of additives within a compound. Tests that have been useful in the study of VideoDisc compound materials include thermal analytical methods, Brabender torque rheometry, and the Instron Capillary Rheometry. In addition, Scanning Electron Microscope (SEM) analysis is mandatory for study of the molded disc surface quality because of video signal element dimensions.

Heat Stabilizers are chemical additives required to retard the thermal degradation reaction of the base PVC resin. Under the high temperature conditions involved in processing, HCl can split out of the PVC chain and lead to unzipping of the polymer molecule if inadequately controlled. The most widely used stabilizers are metal organic salts such as lead, barium, and cadmium stearates and organo-tin compounds such as the tin maleates and tin mercaptides. These materials function to react with the HCl generated and with open bond positions in the polymer chain to inhibit further degradation. Stabilizer efficiency varies according to the total metal content and organic reactant groups. Materials and concentrations of each of the above types can be selected to provide adequate thermal stability for VideoDisc processing, particularly in compression molding where maximum temperatures are in the order of 170°C. Injection molding, however, with its higher process temperature and shear rate parameters places more stringent demands on the materials. Stabilizer selection for compound optimization is determined

to a large extent by its effect on the molded disc surface quality as well as overall compound thermal stability.

In the compounds used in early VideoDisc development and listed in Table 1, barium cadmium stearate type stabilizers were replaced by a liquid tin maleate. This resulted in improved disc surface quality due to better compound homogeneity, and the compound performed well during compression molding. Early injection-molding studies, however, showed a breakdown of the tin stabilizer at the higher process temperature (in the order of 190°C). This resulted in staining of the mold stamper surface, due to volatile by-products, and increased blisters in the disc surface. An extensive study of various stabilizer materials was, therefore, undertaken. It disclosed that the inherent thermal stability of the additives had a direct bearing on molded-disc surface quality. Tests further showed that certain stabilizers of the solid organo-tin type had the lowest volatility at temperatures in the order of 200°C. Compounds subsequently developed using the solid tin stabilizers produced excellent process stability and surface quality.

Lubricants are materials required to provide adequate processability of PVC compounds during compound processing and disc molding. Such materials have a two-fold requirement, namely, to control shear effects between resin particles and to aid fusion and, secondly, to reduce interfacial frictional effects between the compound and process equipment surfaces. In this second role, they also act as a release during molding to prevent sticking of the molded disc to the mold surface. Lubricant materials are generally classified as internal and external according to their function in a compound. Internal lubricants are highly compatible and act like a plasticizer; external lubricants are less compatible and tend to migrate to the surface in processing. Both types are derived from similar materials, such as various waxes, oils, and low molecular weight polyolefins, and their functional behavior is determined by their chemical compatibility with the base resin.

Selection and performance of lubricants for VideoDisc compounds is guided by the process requirements and operating parameters, and by the molded-disc surface quality. The effect of the lubricants on the disc surface quality is the dominating factor in compound optimization, since a variety of lubricants can provide adequate process performance. As is the case with stabilizer additives, the behavior of lubricant materials is highly dependent on the molding process. Prediction of performance based on laboratory tests is difficult and, at best, useful only to establish general behavior. With compression-type VideoDisc compounds, calcium stearate provided good process performance but was found to contribute to surface noise, probably as a result of skin effects. It also affected moisture sensitivity as noted previously. Substitution of a Monton acid ester wax reduced playback noise by 2 dB.

Injection molding, with its increased shear rate and higher temperature operation, places different requirements on the lubricant system. The high shear stresses experienced through the injection nozzle can produce a separation of lubricant additives because sensitivity to bleed-out of materials is increased. Selection and control of the lubricant compatibility and addition level is more critical than in compression molding. In order to provide acceptable performance, the lubricating action of other components must also be considered. Studies of various lubricants showed that organic acid and alcohol ester waxes used in combination with a lubricating processing-aid additive provided better control and a wider latitude of additive levels than other lubricant types. These waxes also exhibit low volatility at the temperatures encountered during molding and produced no detrimental effect on the molding stamper or disc surface during injection runs of the order of 2000 discs.

Process aids are non-PVC resin base additives that function to improve fusion and melt blending of PVC compounds and aid compound flow uniformity during molding. The most common materials used include acrylic, ABS, and EVA type resins. These materials are generally not compatible with the base PVC resin and remain as a separate phase within the compound matrix. Also, the melt and fusion temperatures may be considerably higher than the PVC, and the discrete particles can remain. This must be considered when used in VideoDisc compounds, as process-aid particles can impart a fine structure to the disc surface causing increased high frequency noise. Studies with acrylic type modifiers showed no apparent effect on disc surface noise at concentrations up to 3%.

The effect of acrylic process aids in acetate copolymer base compounds is much less than when they are used in homopolymer systems. Capillary rheometer tests show the high flow PVC-acetate compounds without process aid produces a smooth glossy extrudate surface over the shear-rate test range of 4–1500 sec^{-1} . Equivalent homopolymer compositions, however, exhibit a reduction of surface smoothness and gloss with increase in shear rate, mainly as a result of their poorer fusion and flow characteristics. Addition of a suitable process aid eliminates these surface flow effects.

Compression-molding-type compounds show little difference in performance with the addition of a process aid since shear rates encountered in compression molding are low. Injection-molding studies, however, show a marked difference in compound behavior as a function of process aid addition. PVC compounds without process aid exhibit banding due to nonuniform flow effects. Addition of an acrylic process aid improves flow uniformity and eliminates this problem and is a necessary part of an injection molding composition.

Other Additives to the compound that may be used include a colorant to impart a certain surface appearance and flow modifiers such as plasticizer type materials to reduce melt viscosity. Selection of such materials must be guided as above, i.e., according to their compatibility within the compound and effect on disc surface quality. These types of additives are not required for VideoDisc compounds of the nonconductive type in either compression or injection molding compositions.

2.3 Compound Rheology

The study of melt properties is a necessary part of VideoDisc compound development, since it provides significant data on the effects of materials and permits the assessment of behavior under approximate process conditions. The use of various rheometric techniques in the study of plastic materials is well documented in the literature, and their application to audio-type PVC compounds was reviewed recently by Khanna.⁶ Of the available test methods, the Brabender torque rheometer and the capillary rheometer have been used extensively in the study of VideoDisc compounds.

The Brabender torque rheometer with mixing head attachment is useful in measuring the fusion characteristics of compounds, the effects of various additives, and for relative comparisons of compound melt viscosity and lubricity. Variation in dry-blend fusion time as a function of additive type and amount provides a first-order characterization of the additive's effect within a compound. Lubricants, for example, decrease fusion rate with increase in level in proportion to their internal-external behavior. The lubricating effects of other components are measured in a similar manner as are combination effects. A fast fusion rate is generally desirable in compounding processing, since it extends melt blending time through the compounding system. Examination of equilibrium torque, release properties from the mix rollers, and compression molding of melt samples in a laboratory bench press give further insight to process behavior. This type of data has been used to optimize VideoDisc formulations by correlation to process and molding performance. Typical behavior of a VideoDisc injection molding composition is shown in Fig. 5.

While the torque rheometer gives useful relative data on melt viscosity, a capillary rheometer is required for more in-depth rheological study. Instruments of the Instron type provide shear stress data over a broad shear-rate range by controlled temperature and shear-rate parameters. Typical data for VideoDisc compounds with different base resins is presented in Fig. 3 over a shear-rate range of 4 to 1500 sec^{-1} . The data is uncorrected from direct shear-stress measurements, as corrections

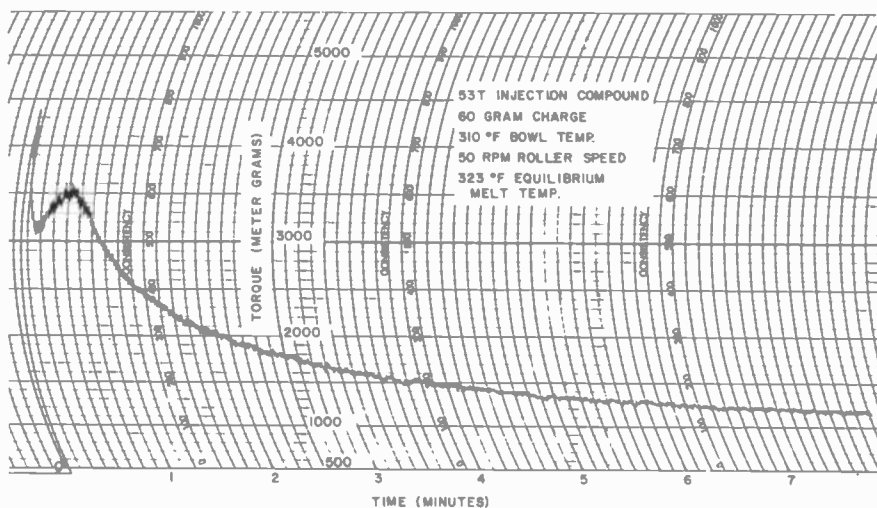

Fig. 5—Typical Brabender characterization curve of an injection molding VideoDisc compound.

for capillary entrance and exit effects with PVC materials are small. As noted previously, the effect of resin on compound flow behavior is apparent.

A closer analysis of compound and additive behavior can be obtained by study of the change in shear stress as a function of shear rate and its correlation to extrudate quality. As shear rate is increased, a critical level is reached where melt flow becomes unstable or turbulent, and a change in slope of the shear-stress curve results. This effect is also observed in the extrudate as evidenced by increased waviness or surface structure. By careful analysis, the critical-shear-rate point can be approximated for different compounds. This type of study is useful in the development of injection molding disc compounds where high shear rates are encountered in the injection cycle. A comparison of critical shear rate data for compounds made with different resins and additive systems is summarized in Table 2. Study of disc surface quality by SEM and playback analysis showed significantly better performance for the

Table 2—Critical Shear-Rate Data of Various VideoDisc Compounds

Compound	Resin Type	Additive System	Critical Shear Rate (sec^{-1})
A	PVC	1	660
B	PVC	2	1360
C	PVC-P	1	1360
D	PVC-P	2	3040

compound exhibiting a high critical shear rate. Compounds with a low critical shear rate can produce unstable flow effects or jetting through the injection nozzle and affect the microsurface structure on the disc.

Both the torque and capillary rheometers can be used to measure the heat stability of compounds at a constant temperature and constant torque or shear rate. Onset of degradation is calculated as the point where torque or shear stress starts to increase. The main difference between the methods is that the torque rheometer measures a dynamic heat stability under constant mixing conditions, while the capillary method measures a static stability under a low shear rate plug flow. The capillary method is useful to measure both heat stability and homogeneity of a given disc compound and is used in the quality control of disc-compound production. For homogeneous compound samples, both methods give equivalent stability times at the same test temperature. Injection compounds are generally tested at 200°C where optimized compounds exhibit stability times in a range of 15 to 20 minutes. A compound with poor dispersion of ingredients will show a capillary stability time under 10 minutes and show more variation of the shear stress curve.

Other rheological test methods such as the Weissenberg rheogoniometer and mechanical spectrometer extend the test range under dynamic conditions to low shear rates. These enable study of melt elasticity and material properties in the solid state region. The relationship between these properties and disc processing and playback characteristics must be established and is under current study.

3. Compound Processing and Control

The VideoDisc performance requirements are extremely critical and lead to the following demands on a compounding system: (1) a specifically designed formulation, (2) the highest degree of dispersion of the components, and (3) extreme cleanliness of the product. To accomplish this, the base ingredients are first pre-mixed in a high intensity mixer to separate agglomerates and to distribute each particle in the dry blend matrix. This blend is then compounded in a twin-screw extruder where a combination of external heat plus shearing action result in a uniform melt blend without polymer degradation. This melt blend is then formed into pellets and stored in a closed system for subsequent injection or compression molding. The details of the RCA VideoDisc compounding system are shown on the compound flow sequence chart in Fig. 6. The major aspects are discussed in some detail below.

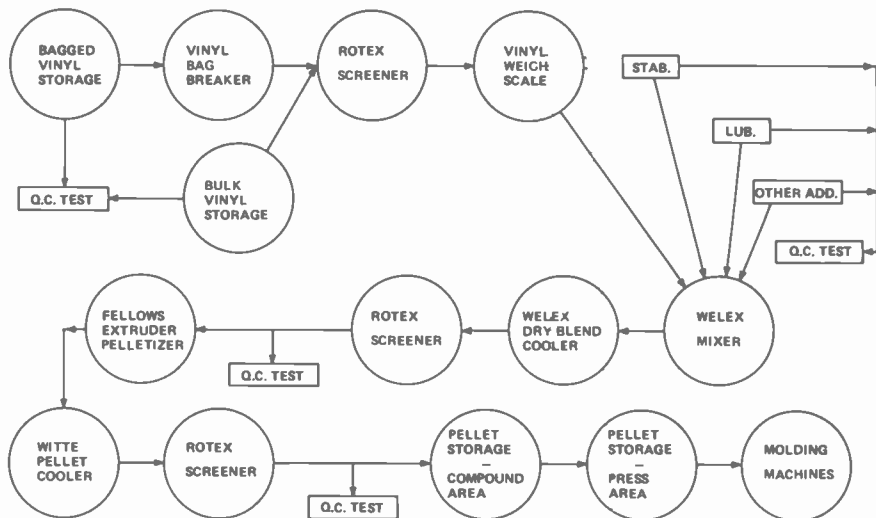

Fig. 6—VideoDisc compounding process flow sequence.

3.1 Mixing

Previous experience with various blending and mixing equipment had shown that the high intensity batch mixer produced the best dry-blend uniform dispersion of ingredients. This is a bowl with a high speed agitator projecting from the bottom. The material is pulled into a vortex at the center of the agitator and then circumferentially around the center of the bowl. A great deal of shear is generated in this process and the material temperature can be raised to 250°F in a 10–15 minute cycle. The main advantage of the high intensity mixer is that different additives can be incorporated sequentially and at predicted temperature levels. After mixing to a desired maximum temperature, the batch is discharged into a separate unit for cooling to room temperature. Batch size is typically 250–300 lbs for a particular nonconductive VideoDisc compound.

High intensity mixers and cooler systems were evaluated from several manufacturers and all performed satisfactorily. Selection of one system over another was based on total system design according to system layout and production rate required. The Welex system was chosen because its M300 model mixer and cooler combination most suitably matched the design-output requirements. A system of this type is shown in Fig. 7.

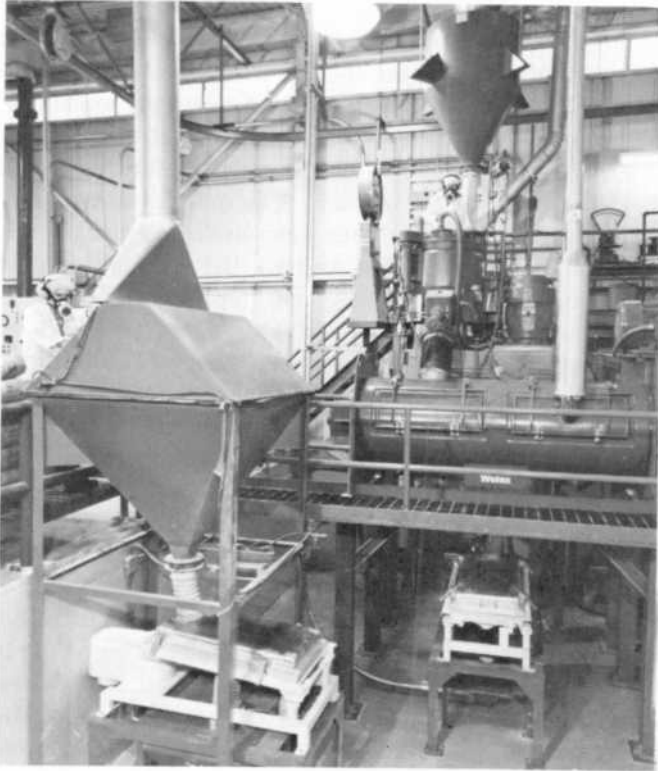

Fig. 7—Dry-blend mixing system.

3.2 Compounding

Many audio record compounding operations use discontinuous systems. The dry blend is made in a ribbon blender, or high intensity mixer, transferred to a Banbury mixer for compounding, and transferred to a two-roll mill for sheeting and subsequential final grinding. Initial development and pilot production of VideoDiscs used compounds produced in such a system. Also, small amounts of samples of developmental compounds are still processed in a similar system using a high intensity mixer and small Banbury and two-roll mill.

Continuous systems involving single or twin screw extruders are much preferred over the above from a cleanliness and reproducibility point of view. After a survey of the industry and the available compound process equipment, the twin screw extruder with intermeshing screws was chosen for a production system. This type of system offers greater processing flexibility, better control of compound shear and temperature, positive throughput and self cleaning action, and good volatile removal

capability. Following study of various units, the Fellows-Reifenhausen counter rotating screw system was selected. The main advantages of this type of unit are better control of shear, a wider screw design flexibility, and the ability to obtain sufficient shear at relatively low screw speeds (40 rpm as compared to 200 to 300 rpm for co-rotating systems). Operation at high screw speeds increases the potential for thermal degradation with VideoDisc type compounds. The main disadvantage for the counter rotating principle is greater wear on screws and barrel.

To complete the compounding system, the BT-100 twin-screw extruder with 4-inch-diameter screws was equipped with a pelletizing die and hot face cutter. Hot pellets are transferred to a Witte vibrating cooler. No water is introduced; pellets are cooled by air bubbles through the transported pellets. This compounding system has been used in the pilot manufacturing of VideoDisc compounds of the copolymer and homopolymer types at output rates up to 900 pounds per hour. The BT-100 extruder is shown in Fig. 8.

The complete compounding system operation from dry blending to cooled pellet output is controlled at a master panel and auxiliary panels at the mixer and compounder units. Resin is fed into a Rotex screener from bag or bulk supply and automatically weighed into the mixer. Compound additives can be added automatically or manually in stages at preset temperature levels. Completed dry blend at 200–250°F (depending on formulation) is dumped into the cooler. Cooled dry blend is fed through a Rotex screener to the twin screw extruder in a continuous manner. Material is compounded, pelletized, cooled in the Witte cooler, screened through a Rotex screener, and transferred to compound storage. Storage in tote bins and drums and direct transfer to the production molding area has been used with this system. In a full production operation, this type of compounding system can be operated in a continuous semi-automatic manner and is completely closed from the raw-material input point to the production molding machines. As seen in Fig. 5, quality control test samples are taken at various stages of the process. Raw materials are tested initially by lot for composition, consistency, and performance in a standard laboratory formulation. Dry blend and finished compound is then sampled and tested for consistency, heat stability, and rheological properties.

4. VideoDisc Molding Processes

Two production methods have been developed within RCA for the molding of VideoDiscs using PVC base compounds—compression molding using typical audio record type equipment and injection molding. Compression molding is the oldest method used for the pro-



Fig. 8—Twin-screw compounding extruder.

duction of audio records and still remains today the technique used almost exclusively for 12-inch-record production. A survey of audio-record molding is included in Ref. [1].

VideoDisc molding by either compression or injection can be generally described in the process flow diagram of Fig. 9. Pelletized compound is transferred into the extruder hopper, plasticated through the extruder to a desired temperature, and a controlled shot of molten compound is delivered to the press. The molten compound is molded under controlled heat and pressure to form the disc; discs are transferred to a post-process step, e.g., deflashing, and then stacked. Although process parameters differ between the methods, the major differences are in the actual disc-molding stage and method of introducing the material into the mold. Both methods utilize nickel molding stampers containing the VideoDisc program information clamped to the surfaces of the press mold. The matrix process for forming the nickel stampers is discussed below.

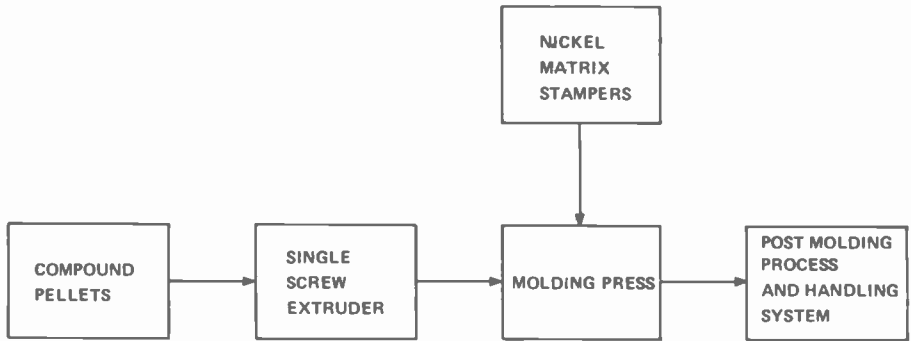

Fig. 9—VideoDisc molding process flow sequence.

4.1 VideoDisc Matrix Process

Matrix is a term used in the record industry for the process of electroforming thin metal replicas of the recorded sound master for use in the molding operation. The process sequence used for production of VideoDiscs is similar and is outlined in Fig. 10. Parts are inspected after each step for possible defects. The recording master, consisting of either an electromechanically cut copper disc or an electron-beam recording in a photoresist-like organic material on a rigid metal substrate, is first nickel electroformed to produce a 0.015-inch (0.038-cm) thick nickel matrix master. The electron-beam master is coated initially with a thin layer of evaporated gold. The nickel matrix master is then electroformed into a series of nickel matrix molds of the same thickness as the master. Each nickel mold is then electroformed in a similar manner into a series

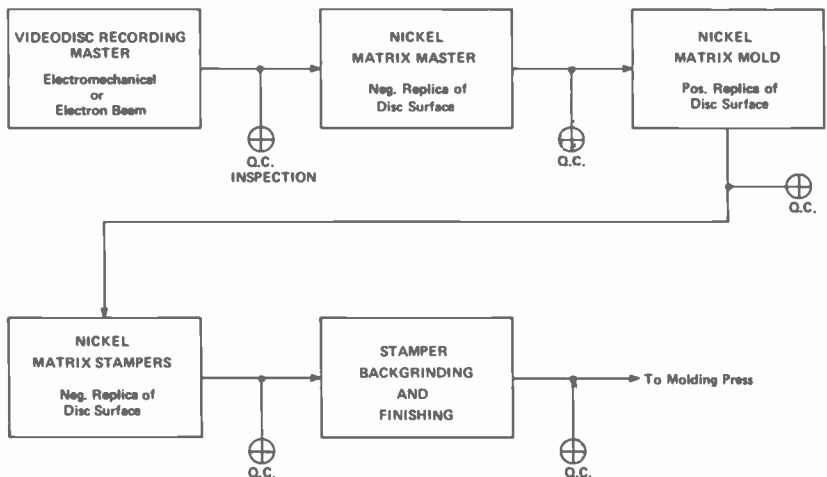

Fig. 10—VideoDisc matrix process flow sequence.

of nickel stampers 0.007–0.008-inch (0.018–0.020 cm) thick for use in molding discs.

The production of VideoDisc stampers from masters is the same as that used in audio record manufacture except that it is highly refined. The same basic processes for metal-to-metal duplication, utilizing nickel as the electroformed metal, and passivation of the nickel surfaces for duplication are used. The major process improvement for VideoDisc matrix production is in the cleanliness of all solutions used in the process and precise control of their operating parameters. The cleaner, acid, and passivation tanks are equipped with pumps and filters that remove all particles larger than 1 μm and are operated continuously. All processing tanks are covered to reduce atmospheric contamination. The filters and solutions are changed on a rigid schedule and are tested daily.

The nickel electroforming solutions are of the low chloride nickel sulfamate type of standard concentration. No additive agents are used. Stress is maintained at a very low level by scheduled carbon treatment and rigid control of impurities by trace element analysis using an atomic absorption spectrometer.

After electroforming, parts are separated, cleaned in a mild alkaline cleaner, rinsed, sprayed with anhydrous isopropanol and dried in a Freon vapor degreaser. All parts are then inspected for surface quality under a bright projection lamp. Inspection is critical to assure quality of the subsequent part or molded disc. Quality-control inspection procedures include inspection in a class-100 clean hood under a 1000-watt inspection light at an oblique angle. Particular defects are further observed microscopically. Parts are inspected for scratches or physical damage, stains, dents or creases, shiny spots, and fingerprints. Rejection criteria include scratches or physical damage that obliterates a groove and are at least two complete signal elements wide, stains obvious under the bright light that can mask signal elements, any sharp dents or creases, shiny spots of greater than 3 sync marks (equivalent to 2 TV lines), and any visible fingerprints. VideoDisc matrix part yield with the above inspection runs greater than 95%.

After inspection, all matrix parts are spray coated on the information surface with a vinyl strippable coating for subsequent part finishing or storage. This prevents potential atmospheric corrosion and handling damage.

Following electroforming and inspection, nickel stampers are prepared for use in the molding process by abrasive grinding of the back surface and trimming and coining to conform to the press mold configuration. Backgrinding is done in a manner similar to audio stampers, i.e., fine grit abrasive cloths are used to reduce the fine nodular pattern of the nickel plating. This step is important in controlling the resultant surface of the

molded disc, which is influenced by the nodular pattern. Centering, trimming, and coining is accomplished in a single operation. Stampers are placed on a die vacuum positioning table in a four-post hydraulic press and centered by means of four video cameras and a centering groove on the stamper. The press is then closed, trimming and coining the O.D. and I.D. simultaneously. The finished stampers are then inspected for TIR (a measure of centering accuracy) and general dimensions. Centering accuracy is better than 0.003 inch (0.008 cm) and average finished stamper yield is above 85%.

Aligning of the stamper to the mold requires critical control to maintain good TIR through the molding process. In injection and automatic compression molding, this is accomplished by positioning the mold pack assembly on an aligning fixture by means of locating pins. The stamper is aligned with four video cameras and an aligning ring, and fixed in place by tightening down the O.D. and I.D. hold down rings. When both stamper halves are set in, the mold pack assembly halves are bolted together for mounting in the press.

4.2 Compression Molding

This process was used exclusively in the development of the RCA VideoDisc system up to 1975 and is still a viable production method. The compression process is characterized by the following:

- (1) thermally cycled mold
- (2) melt temperatures in the order of 350°F
- (3) horizontal mold orientation
- (4) open to the ambient
- (5) medium flow and medium heat stability compound requirements
- (6) low process material shear rates
- (7) low molded part stress

Typical semi-automatic processing uses a four-post automatic cycle compression press tied into a separate two-inch vertical single-screw extruder. The extruder is heated electrically through four barrel and die zones and programmed to supply a controlled weight shot of molten compound (typically 180 grams) in synchronization with the press cycle. A 100-ton-hydraulic-compression press is used, with the mold thermally cycled by controlled high pressure steam and cooling water. The full press cycle including closure time, hydraulics, steam, and water cooling is controlled automatically. Mold temperatures are typically controlled to 365°F at the steam cycle and 90°F at the cooling water cycle. Total cycle time, depending on the compound, is between 24 and 40 seconds with the heat phase being 25 to 35% of the total time.

In semi-automatic disc compression molding, a typical cycle is as follows:

- (a) the extruder activates, forming a shot of compound measuring approximately three inches in diameter by one inch thick and weighing 170–180 grams, while the opened press mold is heating.
- (b) the extruded shot is manually transferred to the center of the heated lower mold surface.
- (c) the hydraulic cycle is initiated, closing the press and flowing the plastic radially out across the stamper surfaces.
- (d) excess compound forms an approximate one inch wide flash on the outside circumference of the mold. Press closure is controlled by a thin flash of compound approximately 0.005 inch (0.013 cm) thick between the two stampers at the outside bead edge.
- (e) after the cooling cycle, the press opens and the disc is manually transferred to an edging station; the extruder and heat cycle activate for the next press cycle.
- (f) the disc is deflashed and manually stacked. A flat aluminum spacer is inserted in the stack after every five discs to maintain good flatness.

Compression molding in a fully automatic press involves the same process sequence as above, except that the transfer of molten shot and the transport, trimming, and stacking of the discs are automatic.

Compound requirements for compression molding are determined by the available molding temperature and shear parameters of the process. Ideally, the mold temperature should be higher than the shot melt temperature to effect good surface replication and minimal cycle times. With lower mold temperature, cycle time must be increased to compensate for reduced melt flow. VideoDisc compounds made with higher-temperature PVC homopolymers and copolymers are generally run at melt temperatures in the 360 to 370°F range and produce good discs at cycle times in the order of 36 seconds.

Analysis of the flow rates involved in the compression process shows that maximum shear rates are low, being in the order of 10 to 100 sec^{-1} . Thus, only mild shear stress is placed on the material. Rheology tests show good stable melt-flow behavior for VideoDisc PVC compounds under these conditions. The low shear rates encountered and time cycle of several seconds at high temperature result in good stress relaxation of the melt prior to cooling and low residual stress in the molded disc. Characterization of compression molded discs by SEM and laser surface analysis⁹ show excellent reproducibility of the signal elements and that good signal-element definition is obtained. Groove- and signal-element depths are replicated to 93–98% of the measured metal stamper depths.

The low disc-stress levels and excellent signal-element definition are the main attributes of the compression process. The chief disadvantages

are limited stamper life due to the movement, or working, of the metal stamper against the press mold during thermal cycling and greater chance of contamination due to the open mold process and trimming operations.

4.3 Injection Molding

The injection process was developed for the VideoDisc in 1975, including both the design of molds and equipment technology. A standard injection process is characterized by the following:

- (1) constant temperature mold.
- (2) melt temperatures above 375°F.
- (3) closed mold to the ambient.
- (4) high process material shear rates
- (5) higher molded part stress
- (6) high-flow-rate and high-heat-stability compound
- (7) vertical mold orientation

The equipment used includes a Husky 300 ton hydraulic clamp molding machine, special design mold and pack assembly built by Husky and an automatic disc handling and spindling system built by Husky. This system is shown in Fig. 11. The process schedule for automatic operation involves the following steps.

- (a) press closes.

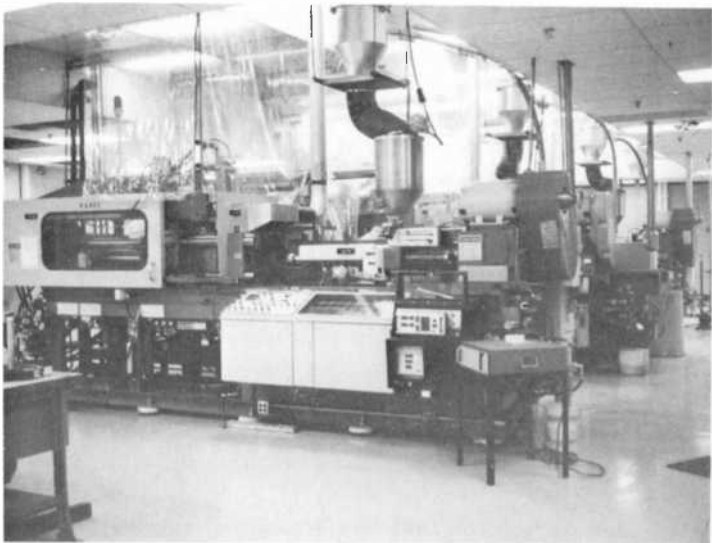

Fig. 11—VideoDisc automatic injection molding machines.

- (b) the disc mold cavity is evacuated.
- (c) compound is injected into the closed constant temperature mold through a center gate in one second.
- (d) the injection-screw ram starts turning and compound in the extruder causes the ram to retract, leaving material for the next shot in front of the ram.
- (e) after the disc is cool and screw retracted, the press opens and simultaneously punches out the disc center hole and sprue.
- (f) the disc is removed from the movable half of the mold by the pickup as the mold reaches full open.
- (g) the press starts to close for the next cycle and the disc is removed from the mold area.
- (h) the disc is loaded onto the handling system by the robot arm and spindled automatically with an aluminum spacer inserted every five discs.

Total cycle time for the molding of nonconductive discs is typically 26 seconds for most compounds. The key aspects of the process, which determine compound requirements, are the high shear rates involved during the injection cycle and the constant low temperature mold. Shear rates through the nozzle during the one second injection cycle are in the order of 10^4 sec^{-1} with an injection pressure of 1500 psi. This is above the critical shear rate for most PVC compounds and unstable flow can occur. Also, high temperatures in the order of 400°F are generated in the nozzle area, making good compound thermal stability mandatory. Further analysis shows shear rates to decrease sharply as the melt flows out radially into the closed cavity.

Since mold temperature is controlled constantly at a low temperature of approximately 135°F, the plastic is chilled instantly as it deposits against the stamper surface with very little lateral surface movement. The combination of fast injection time and cool mold surfaces require high compound melt flow and pressure in order to replicate the fine video signal element geometry. Melt temperatures for VideoDisc compounds are generally in a range of 380 to 400°F. As a result of the high shear rates and temperatures, compound formulation is more critical than with compression molding, as was noted previously in the discussion of compound formulation. Additives must be chosen that are thermally stable at the above temperatures and that will not separate out under high shear stress. Volatiles must also be minimized to avoid potential staining of the stamper and disc surfaces. PVC compounds developed by RCA can be processed at the above conditions and show no adverse surface effects in press runs of 2000 discs.

Good control of the total injection cycle is required to produce discs reproducibly.⁷ The RCA process utilizes a Hunkar ram programming

control system with pressure sensors installed in the center of the mold cavity. Peak cavity pressure controls the material density and resultant weight, shrinkage, surface resolution, and dimensional stability of the molded disc. Once cycle parameters are optimized, the injection ram profile, injection pressure, hold pressure, back pressure, and cavity pressure are controlled automatically. Control of ram profile and pressure is a critical requirement to effect good uniform signal element fill from the inside to the outside of the disc surface.

Characterization of injection-molded VideoDiscs shows higher molded-in stress levels than in compression-molded discs as a result of the high shear rates and rapid cooling of the material. The higher stress has not been found to affect disc performance. The above process effects also result in less fill at the surface. Groove and signal element depths generally measure 5–10% less than comparable compression discs from the same master. The overall advantages and limitations of injection molding in comparison to compression are summarized in Table 3. In general, the injection process produces discs with a better overall quality but puts greater demands on the compound materials. Compounds of the 53T type as described in Fig. 3 and Table 1 perform extremely well in injection and compression molding, producing disc yields in the order of 90%.

Table 3—Comparison of VideoDisc Molding Processes

Advantages	Limitations
Compression Molding Good signal element and groove definition (93–98%) Very low residual part stress Well established process in record industry Relatively low capital and maintenance costs	Limited stamper life Debris generating secondary operations (deflashing) Increased material usage (180 g/disc) Increased potential for surface contamination and blisters Limited control of disc consistency Limited to low temperature materials (mainly PVC)
Injection Molding Good control of part consistency and quality Longer stamper life Less material usage (150 g/disc) Longer mold life (15 million cycles) No debris generating secondary operations Wide choice of materials including non PVC resins	Lower replication definition More stringent material requirements (higher temp. & shear rates) Higher residual part stress Higher capital and maintenance costs

4.4 Disc Inspection and Testing

Molded discs are inspected visually during each run in a manner similar to matrix part inspection. Discs are rejected or press runs terminated pending occurrence of surface defects that can affect playback performance. Discs are also checked for physical dimensions and dynamic acceleration. Acceleration is measured at 450 rpm using a special test turntable and a capacitive probe system. Discs are sampled throughout each press run and performance checked against system specifications for video and audio signal-to-noise ratio, loss of video information, and locked or skipped grooves.

5. Conductive Disc Compound and Molding

The preceding sections reviewed the materials and processes used in the replication of nonconductive VideoDiscs for use in a coated capacitive disc system. During 1977, RCA developed conductive PVC base compounds that enable direct playback in a capacitive playback system without the need for surface conductive and dielectric layers. The material and process aspects of the conductive disc are reviewed below. Specific details of the conductive capacitive disc are reviewed by Fox.⁸

5.1 Formulation Development

Plastics can be made conductive by the incorporation of conductive fillers such as carbon or fine metal particles. Carbon is preferred and has been used in the industry for the formulation and processing of flexible PVC compositions used for cable and microwave shielding and for static-free applications. Little work had been done, however, with rigid compositions suitable for VideoDiscs, and new compositions had to be developed. The approach taken was the modification of existing VideoDisc PVC base formulations using highly conductive carbon. Of the available carbon blacks, Ketjen* EC carbon black, a material manufactured by Akzochemie was found to produce the best results at the lowest addition levels.

When high levels of carbon (in the order of 15% by weight) are added to a standard PVC formulation, three major effects occur: (1) a large increase in internal heat generation due to the frictional effects of the carbon particles during processing, (2) a large increase in shear stress, particularly at low shear rates, and (3) a lowering of lubricity. This results

* Registered trade name.

in a substantial increase in melt temperatures and melt viscosity of the compounds, thus making processing and molding more difficult. The effect of 15% Ketjen EC addition to a 53T type formulation is shown in Fig. 12. Examination of the extrudate surface shows a dull appearance at low shear rates and an increase in gloss with increasing shear rate. Melt elasticity is minimized as evidenced by the practical elimination of extrudate die swell. In the compression molding of discs with this compound, high melt temperatures must be used, resulting in marginal heat stability. The carbon also drastically affects the process lubricity of the compound, thus increasing the chance for compound degradation in the extruder and making release of discs from the mold difficult.

To compensate for the detrimental effects of carbon noted above, the compound lubricant system must be modified and flow modifier materials added to the formulation. Studies have shown that multi component lubricant systems are required along with solid and liquid melt modifiers. Melt modifiers are generally of the plasticizer type. Choice of additives and amount must be closely controlled, as discussed previously, to avoid incompatibility or bleed-out effects during processing.

The characteristics of 72D, a typical modified conductive compression molding compound, are shown in Fig. 12. The compound exhibits good lubricity and a static Instron thermal stability of 15 to 20 minutes at

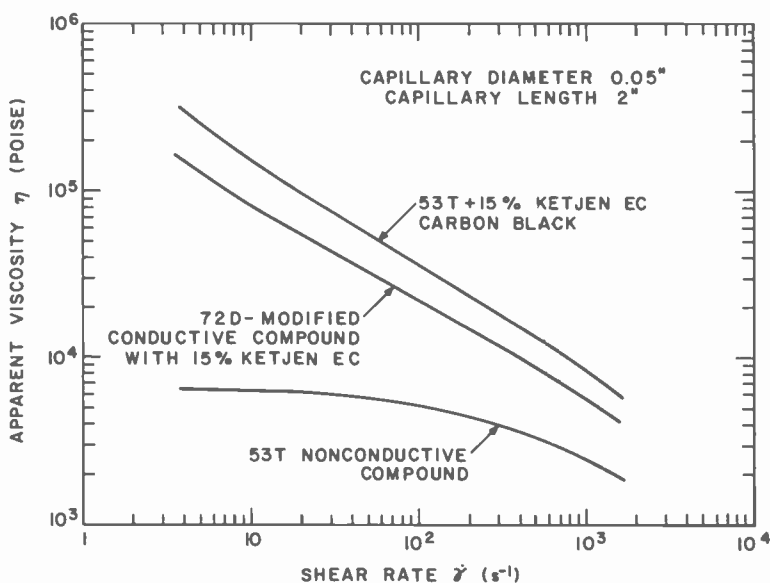

Fig. 12—Melt-flow characteristics of conductive and nonconductive VideoDisc compounds.

200°C. A compound of this type can be compounded and pelletized successfully through a twin-screw system. Compounding equipment is the same as that described previously with the addition of a separate system to weigh and convey the carbon.

5.2 Conductive Disc Molding

Compound of the 72D type has been molded in standard semi-automatic and automatic compression presses. Melt temperatures are in the order of 385°F and cycle times of 36 seconds and 30 seconds, respectively. No problems have been encountered in the extrusion performance of this compound during molding. Although mold temperatures are 20°F lower than the melt temperature and melt viscosity higher than nonconductive compounds, discs of good surface quality and signal element definition are obtained using the same process sequence as described previously.

5.3 Molded Conductive Disc Characteristics

Visual examination of conductive discs under bright light shows a greater occurrence of fine radial surface scratches. These are attributed to the presence of fine agglomerates of carbon and are minimized by better dispersion in blending and compounding. This type of fine scratch does not affect playback performance or signal-to-noise ratio. SEM surface analysis of compression molded discs shows an increased fine background graininess but excellent replication definition of signal elements. Fig. 13(a) shows the compression-molded disc surface detail of replicated signal elements in a test band containing 4.3, 6.3, and 12.3 MHz constant-frequency signals. Fig. 13(b) shows a typical video-program signal-element pattern of a 9541 grooves-per-inch disc.

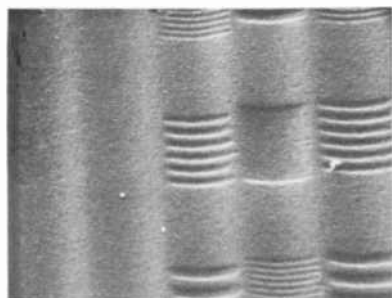

(a) TEST SIGNALS AT 4.2, 6.3, AND 12.6 MHz ON 5555 GROOVES/in. DISC AT INSIDE RADIUS 5k × MAG.

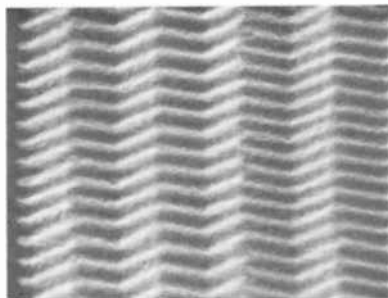

(b) VIDEO PROGRAM PATTERN ON 9541 GROOVES/in. DISC AT INSIDE RADIUS 10k × MAG.

Fig. 13—SEM analysis of compression molded conductive VideoDisc surfaces.

Compression-molded conductive discs show good playback performance and little difference in visual playback quality as compared to coated capacitive discs. Stylus and disc wear characteristics are also similar.

The physical properties of molded conductive discs are affected considerably by the added carbon. Impact strength is reduced and surface hardness is increased. Shock, vibration, and drop tests at room temperature of the as-packaged disc show no apparent problems with the reduced-strength materials. Shrinkage in disc diameter at elevated temperature is also increased with the carbon but is controlled (by compound formulation) to an acceptable level. Disc warp at elevated temperature is decreased by the carbon, with discs exhibiting little static sag warp in tests at 130°F.

The current disc development program within RCA is aimed at the optimization of conductive disc materials and disc processing.

6. Conclusions

The pilot production systems developed at RCA for VideoDisc compounding and molding and the typical characteristics of molded discs have been reviewed. To date, hundreds of thousands of experimental discs have been produced by these systems to confirm production feasibility. The development of conductive disc compounds and their use in the production of capacitive playback discs was also presented. This system has shown acceptable playback performance and offers a simpler process and reduced cost relative to the coated capacitive disc system.

Acknowledgments:

The work embodied by this paper is credited to the various engineering and pilot manufacturing groups in the RCA "SelectaVision" VideoDisc Group in Indianapolis, Indiana. Special credit is given to C. Martin who was responsible for the development of Video Disc compounding, M. Whitehurst for matrix development and M. McNeely for molding systems development. Overall pilot manufacturing systems development is under the responsibility of W. Gordon.

Credit is also given to the basic material development and support efforts of the Material and Process Research Group under L. P. Fox at RCA Laboratories, Princeton, N.J.

References:

- ¹ D. S. McCoy and E. O. Keizer, "The Evolution of the RCA "SelectaVision" VideoDisc System—A Historical Perspective," *RCA Review*, 39, p. 7, March 1978 (this issue).
- ² E. O. Keizer, "VideoDisc Mastering," *RCA Review*, 39, p. 60, March 1978 (this issue).
- ³ D. L. Ross, "Coatings for VideoDiscs," *RCA Review*, 39, p. 136, March 1978 (this issue).
- ⁴ J. C. Ruda, "Record Manufacturing: Making the Sound for Everyone," *Audio Eng. Soc.*, 25, No. 10/11, Oct./Nov. 1977.
- ⁵ *Encyclopedia of PVC*, Vols. I and II, Edited by L. Nass, Marcel Dekker Inc., N.Y. (1977).
- ⁶ S. K. Knanna, "Polymer Science—New Materials for Phonograph Discs," *RCA Reprint RE-22-3-2*.
- ⁷ D. B. Hunkar, "Process Control for Injection Molding," *Plastics Tech.*, Aug. 1974.
- ⁸ L. P. Fox, "The Conductive VideoDisc," *RCA Review*, 39, p. 116, March 1978 (this issue).
- ⁹ I. Grog, "Optical Techniques Developed for the RCA VideoDisc," *RCA Review*, 39, p. 162, March 1978 (this issue).

The Conductive VideoDisc

L. P. Fox

RCA Laboratories, Princeton, N.J. 08540

Abstract—A conductive polymer composition has been developed, from which discs for the RCA VideoDisc system can be compression molded. This development has eliminated the need for the conductive and dielectric coatings previously required for the capacitive pickup. In this article, the material and process considerations are discussed, including the relationship of carbon loading to conductivity, melt viscosity, surface characteristics, and playback performance. The effect of mixing on disc performance, the carbon characteristics required, and the dispersion in the polymer matrix are also addressed. Finally, the advantages of this system over the coated disc are discussed.

1. Introduction

As described more fully in a companion article,¹ the capacitive pickup used in the RCA VideoDisc system requires a conductive disc surface with a thin dielectric coating to prevent shorting of the stylus electrode to the disc. The original construction of this disc consisted of a non-conductive compression-molded disc made from a polyvinyl chloride-polyvinyl acetate copolymer, the surface of which contained the modulating signal information and grooves. The required surface conductivity was obtained by vacuum deposition of a 200-Å thick metallic film, which was then covered by 200 Å of a glow-discharge-deposited organic dielectric film (see Fig. 1).

As early as 1971, RCA experimented with wholly conductive discs, and a program was set up to develop a conductive disc molding compound

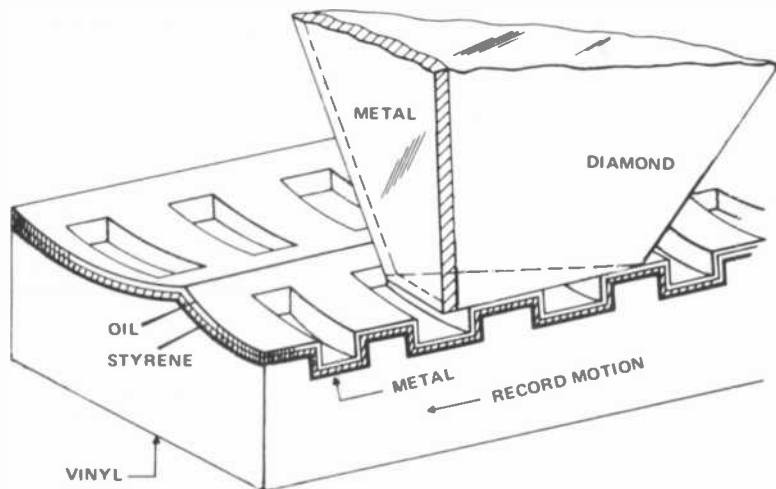

Fig. 1—Cutaway view of stylus tip and coated VideoDisc surface. This figure represents an early stage of development. The stylus shape and the form of the information recorded in the grooves are different in the current system.

capable of being compression molded.² Resin systems tested included:

- (a) polyethylene
- (b) polyvinyl chloride–polyvinyl acetate copolymer
- (c) polyethylene–ethyl acrylate
- (d) polyethylene–vinyl acetate

The basic conductive black used was Cabot Vulcan XC-72. The lowest resistivity obtained for a PVC-PVA material at that time was 510 Ω -cm at 100 MHz. Polyethylene-based compounds were obtained with resistivities at 100 MHz as low as 16 Ω -cm. However, they were sufficiently soft so as to score readily when subjected to a sliding stylus. Playback performance compared to coated discs can be observed in Figs. 2A and 2B.³ As can be seen, the results were quite noisy, which can be understood when one observes the surfaces obtained at that time (Figs. 3A and 3B).

When it became apparent that the coatings described previously and elsewhere in this issue were creating reliability problems, were subject to the corrosive nature of the environment, and were expensive to apply consistently, the search for a conductive disc was intensified. This effort resulted in a conductive molding compound, based on Ketjenblack* EC

* A product of Akzo Chemie, Netherlands.

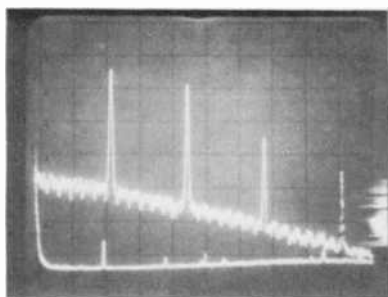

(A)

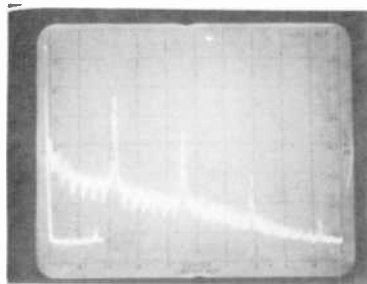

(B)

Fig. 2—Spectrum analyzer scan (A) for metal, styrene, and oil coated disc ($\text{CNR}_{5\text{MHz}} = 35$ dB) and (B) for early conductive disc from the same master as A ($\text{CNR}_{5\text{MHz}} = 22$ dB).

and a propylene-vinyl chloride copolymer, the performance of which has proven to be completely acceptable, eliminating many of the drawbacks of the coated disc.⁴ As the work progressed, it became apparent that there were several fundamental material and process considerations that had to be addressed in order to evolve an acceptable commercial disc. Some of these considerations are discussed below.

2. Material and Process Considerations

2.1 Carbon Loading

The carbon loading level is fundamental to the compound performance and determines the resistivity, the melt viscosity, the physical characteristics, and the surface quality of the disc.

2.1.1 Resistivity

In a companion article in this issue ("Capacitive Pickup and the Buried-Subcarrier Encoding System for the RCA VideoDisc", by J. K. Clemens), the resistivity requirements for the satisfactory performance of the disc are discussed. The objective of the development effort was to achieve a bulk resistivity of less than $10 \Omega\text{-cm}$ when measured at 915 MHz. As will be seen later, a resistivity of $3\text{--}5 \Omega\text{-cm}$ was achieved, which is consistent with the requirements outlined in Clemens' article in order to achieve acceptable performance.

The dielectric film is believed to be formed by a thin surface skin that



(A)

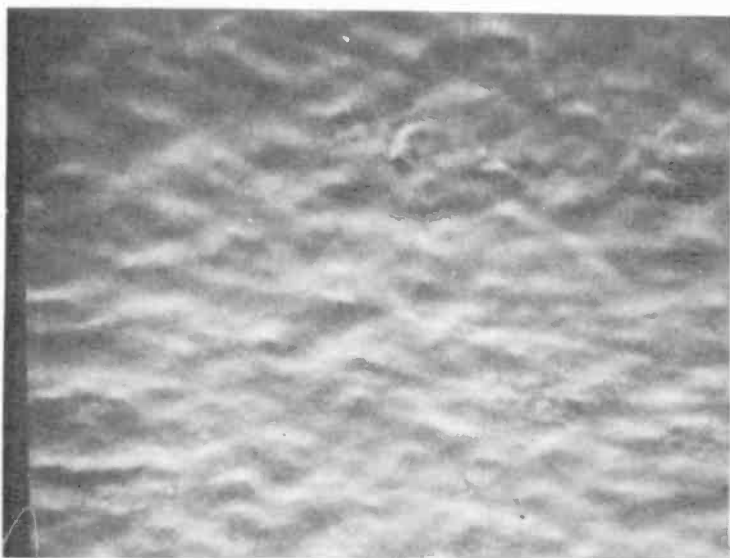

(B)

Fig. 3—Molded surface (A) with 0.2% metallic lubricant in polyethylene ($\rho = 23 \Omega\text{-cm}$ at 100 MHz) and (B) with 35% Cabot Vulcan XC-72 in polyvinyl chloride-acetate copolymer ($\rho = 510 \Omega\text{-cm}$ at 100 MHz). Magnification in both cases is approximately 18,000X.

is rich in polymer as a result of being molded against a surface. Additionally, the lubricant used to enhance stylus life has been shown to raise the stylus above the level of the disc surface during rotation, thus creating a thin insulating film and preventing a short from occurring to the metal electrode on the stylus. Some compound formulations have been shown to generate discs that are playable unlubricated without damage to the disc, suggesting that the combination of the polymer-rich film and molding lubricants that exude to the surface are sufficient to form a satisfactory dielectric film.

At the carbon loading levels required to achieve these resistivities, other material characteristics, such as melt viscosity and physical properties, are dramatically affected. Thus, the selection of an acceptable carbon loading level represents a compromise among these properties. The literature⁵⁻⁷ tells us that the preferred concept of conductivity depends upon the principle of electron tunneling, wherein the tunneling current is an exponential function of the gap width between adjacent particles or aggregates. Therefore, the average width of the gaps between the particles or agglomerates determines the conductivity of the carbon-resin composite. The factors to be considered in selecting the type of carbon are discussed later. However, Table 1 gives some representative resistivity values obtained for several different types of carbon in a rigid polyvinyl chloride system. It can be seen that resistivity varies considerably, depending on the type of carbon. Lowest resistivities were obtained with the Ketjenblack EC. Since the system depends on the passage of a 915-MHz rf current through the conductive surface of the disc, the important resistivity is that measured at 915 MHz. The ac conductivity of disperse systems is fully described elsewhere.^{8,9} Early studies by Kawamoto¹⁰ showed a significant dependence of resistivity on frequency. More recent studies, based on improved techniques and reduced contact resistance, have shown this dependence to be small, particularly in the low resistivity range. Fig. 4 is a plot of resistivity (dc and 915 MHz) versus carbon loading for the Ketjenblack EC-rigid polyvinyl chloride

Table 1—Resistivity Values for Typical Carbon-Propylene Vinyl Chloride Copolymer Mixtures

Carbon	Weight %	Resistivity (Ω -cm)	
		915 MHz	DC
Columbia R3500	25	120	76.8 K
Columbia Conductex 950	25	120	14.2 K
Cabot Vulcan XC-72	35	29	360
Cabot Vulcan XC-72	30	450	∞
Ketjenblack EC	15	9.5	43
Cabot Mogul L	30	1000	73,000

system, which has been compounded in a Brabender extruder. As can be seen, the resistivity is a steep function of the carbon content and does not appear to level off, even at the 19% by weight loading level. Loading levels greater than 19% of the Ketjenblack EC are impractical in rigid PVC systems, since the compound cannot be processed due to the high

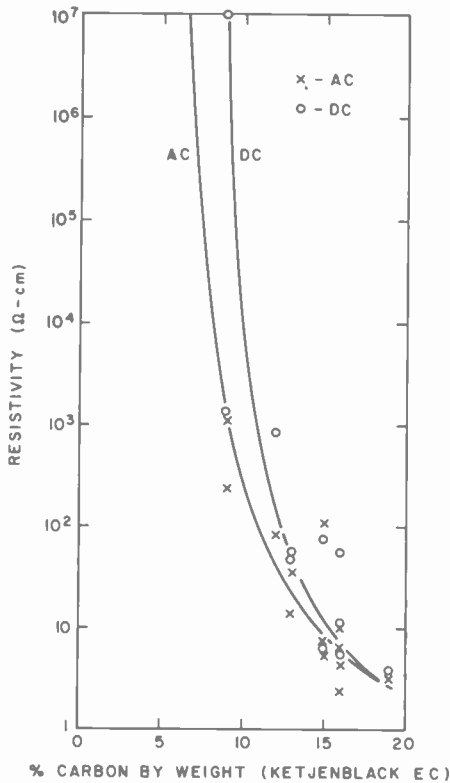

Fig. 4—915 MHz and dc resistivity versus carbon loading in a PVC-based system.

shear stress developed from the particle-particle contact. It can also be seen that, although there is considerable scatter in the data, the difference between the 915-MHz and dc resistivities decreases to nearly zero as the resistivity decreases to a minimum of 2–5 Ω-cm.

Finally, the resistivity has a direct bearing on the performance characteristics of the conductive disc. In general, it has been shown¹⁰ that the carrier output may be expressed as

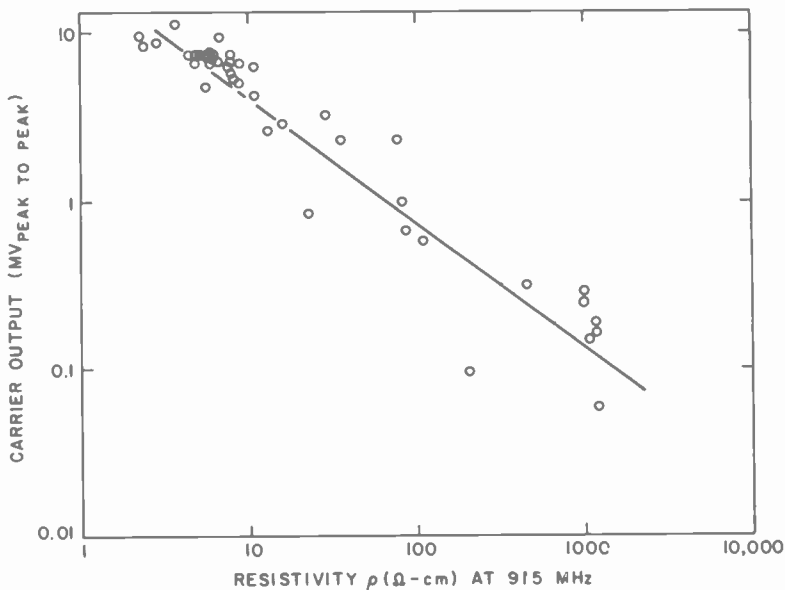

Fig. 5—Carrier output versus resistivity (915 MHz) of a carbon loaded PVC-copolymer resin system.

$$C = 20\rho^{-2/3}, \text{ (see Fig. 5)}$$

where C = carrier output in mV peak-to-peak, and ρ = disc resistivity in ohm-cm at 915 MHz; and

$$\text{CNR} \sim \rho^{-3/10}, \text{ (see Fig. 6)}$$

where CNR = 5 MHz carrier-noise ratio.

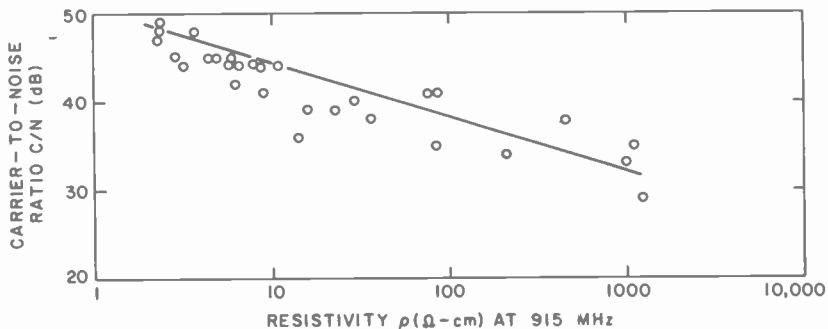

Fig. 6—Carrier-to-noise ratio (at 5 MHz) versus resistivity of a carbon loaded PVC-copolymer resin system.

2.1.2 Rheology

Polymer melts typically display non-Newtonian flow behavior of the pseudoplastic or shear-thinning type. This means that as the shear rate ($\dot{\gamma}$) increases, shear stress (τ) increases but at a rate that is not proportional to $\dot{\gamma}$ (see Fig. 7). Filled systems tend to behave such that at low shear rates the melt acts like a solid and does not flow at all until some critical shear stress, called a yield stress, is reached. Such a material is called a Bingham fluid (see Fig. 7). An equation that describes the viscosity of many kinds of suspensions over a wide concentration range is the Mooney equation;¹¹

$$\ln \left(\frac{n}{n_1} \right) = \frac{k_E \phi_2}{1 - \phi_2 / \phi_m},$$

where

n = viscosity of the suspension,

n_1 = viscosity of the suspending liquid,

k_E = Einstein coefficient,

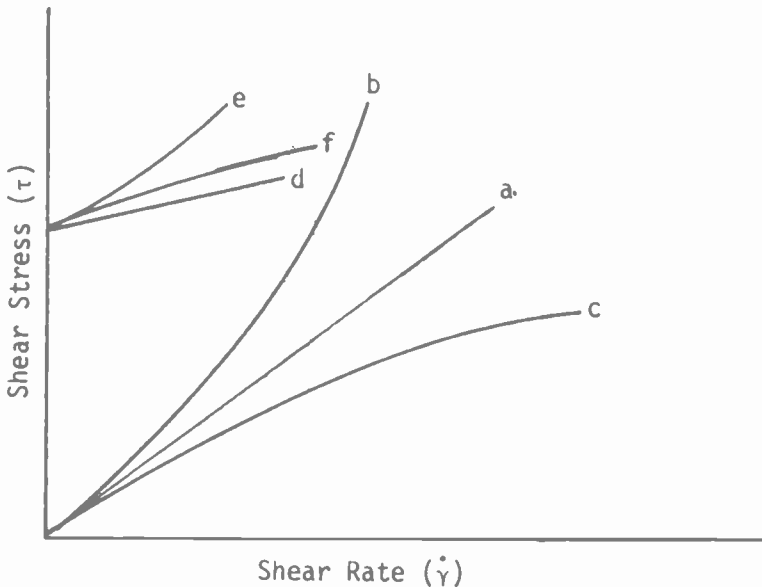

Fig. 7—Hypothetical plot of shear stress versus shear rate for different types of fluids: a. Newtonian, b. dilatant or shear thickening, c. pseudoplastic or shear thinning. Curves d, e, f are Bingham fluid versions of a, b, c, respectively.

ϕ_2 = volume fraction of the filler,
 ϕ_m = maximum possible filler volume fraction

Mathematical treatment of this and other flow equations is adequately handled elsewhere.^{12,13}

Fig. 8 is a shear stress versus shear rate plot of various concentrations of Ketjenblack EC in a propylene-vinyl chloride based resin system. It can be seen that the material behaves as a normal pseudoplastic Bingham fluid, wherein the flow curve moves upward with increasing carbon

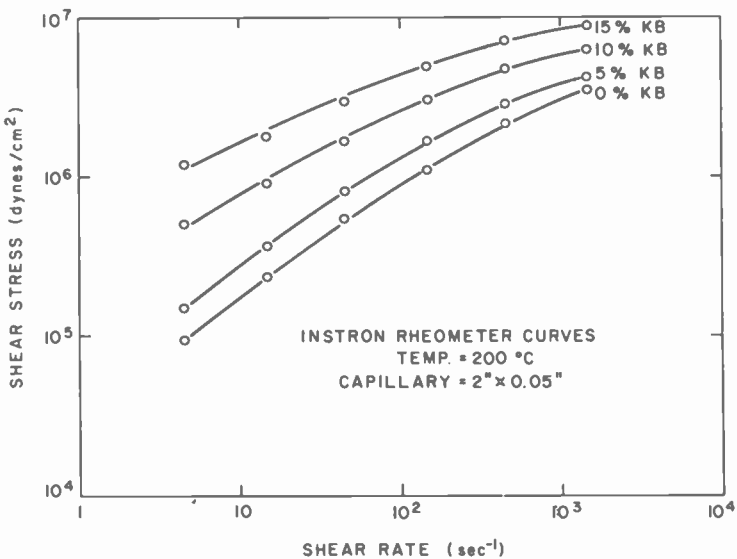

Fig. 8—The effect of carbon loading on the melt flow characteristics of a propylene-vinyl chloride copolymer.

loading, particularly at low shear rates. The uncorrected apparent viscosity curves for these same materials are shown in Fig. 9. Since the surface reproduction, particularly for compression molding, is believed to take place at the lower shear rates (in the order of 10 sec⁻¹), the effect of carbon loading density is quite important. Flow modification to reduce the low shear rate viscosity is required in order to produce optimum surface replication. It is interesting to note that the melt viscosity takes a large jump at 5–10% by weight Ketjenblack EC, implying that particle-particle contact and resistance to flow has been initiated. This can be verified if one looks at Fig. 4, which shows that a reasonable conduc-

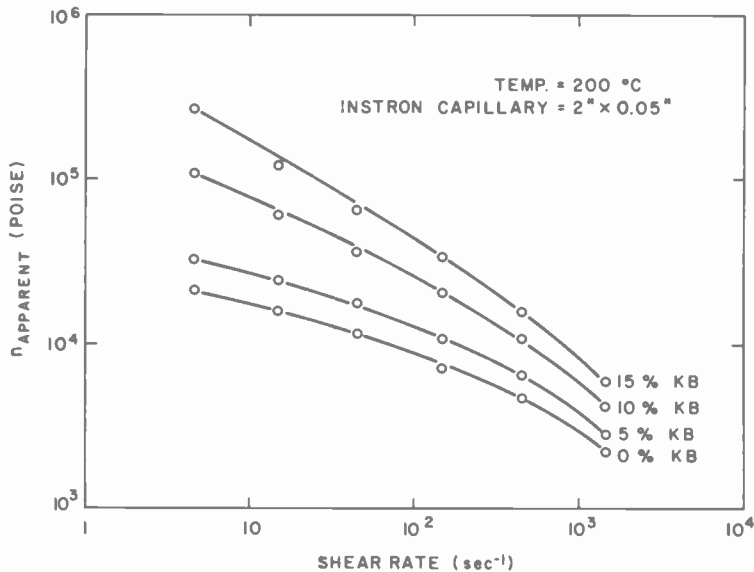

Fig. 9—The effect of carbon loading on the apparent viscosity of a propylene-vinyl chloride copolymer.

tivity of the filled polymer begins to occur close to 10% by weight loading level.

2.1.3 Physical Characteristics

The properties of composite materials are determined by many factors, including the properties of the components, the shape of the filler phase, and the nature of the interface between the phases. An important property of the interface that can greatly affect the physical properties is the bonding strength between the phases.¹² The characteristics of most importance to the VideoDisc are:

a. Resistance to scoring—Rigid fillers are much harder than the polymers in which they are dispersed. Therefore, it is not unexpected to find the hardness of the composite to be increased over that of the polymer matrix alone. Tests were run at RCA¹⁴ using a specially constructed apparatus to measure score resistance, which is one of many possible measures of hardness. The method devised was a slight modification of the Bierbaum Scratch Hardness Test.¹⁵ This apparatus

consisted of a turntable that drives the sample to be tested under an 18- μm -radius spherical diamond stylus. Variable load is applied to the stylus by means of a galvanometer-like device through which a calibrated variable current is passed. Scratch depth was calculated from microscopic measurements of scratch width, and was plotted against applied load. Fig. 10 is a plot of scratch width versus applied load for a PVC-PVA copolymer loaded with various amounts of Ketjenblack EC. This copolymer is commonly used in audio records and mechanically played video discs. As can be seen, the addition of the carbon dramatically in-

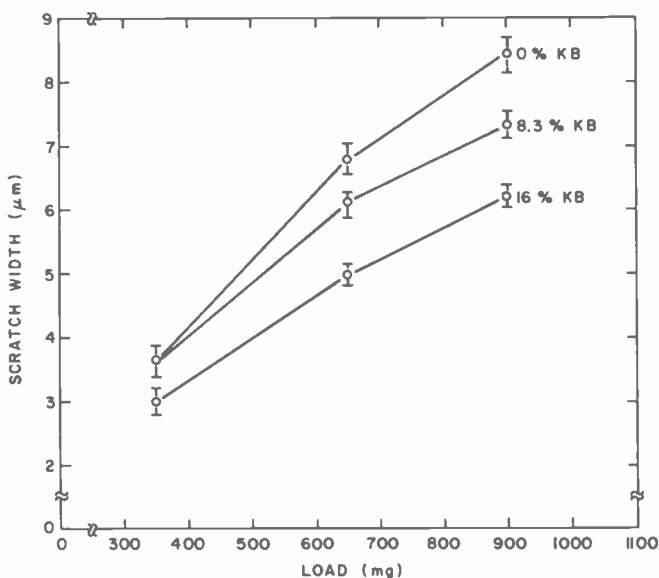

Fig. 10—The effect of carbon loading on the scratch resistance of a polyvinyl chloride-acetate copolymer.

creases the score resistance of the filled polymer over the unfilled material, and the score resistance increases with increasing carbon loading. Thus, at equivalent stylus pressures, discs made from the filled polymer can be expected to exhibit far less scoring than those made from the unfilled material.

b. Disc warp—This is important because of the increased sensitivity to tracking variations imposed at the rotational speed used (450 rpm), which is high compared to the audio rotational speed of $33\frac{1}{3}$ rpm. The commercial product must withstand exposure to a wide variety of tem-

perature conditions. Fillers generally increase the heat distortion temperature¹⁶⁻¹⁹ as a result of an increase in modulus and a reduction of high temperature creep, rather than because of an increase in glass transition temperature (T_g). Limited thermomechanical analysis (TMA) employing a DuPont 941 analyzer confirmed that the addition of carbon to the base resin system has little or no effect on the T_g of the resin system employed. Distortion of the disc depends primarily on the molded-in stresses and the T_g of the base resin. The PVC-PVA systems used in most audio and mechanical video disc systems have a T_g of 70°C and will not meet the warp specifications imposed by RCA for the Video-Disc.* The carbon-filled resin systems used in the RCA discs (propylene-vinyl copolymer or PVC homopolymers) have been shown to have a $T_g > 80^\circ\text{C}$ and will comfortably meet the required specification.

c. Brittleness—Rigid fillers in a rigid polymer generally decrease the impact strength of the system, and the conductive VideoDisc is no exception. However, proprietary additives are capable of modifying this property sufficiently so as to enable the discs to withstand normal handling and drop tests.

2.1.4 Surface Reproduction and Dispersion

Surface characteristics of the molded discs are, of course, quite dependent upon the molding conditions, the filler, dispersion, etc. If one compares the surface of a stamper (Fig. 11A) with that of a compression-molded unfilled disc (Fig. 11B) from a propylene-vinyl chloride copolymer, one sees that the reproduction is exact, with little or no roughness introduced in the replication process. Early experimental attempts in the development of the conductive disc were made with Cabot Vulcan XC-72 in polyethylene and polyvinyl chloride-acetate copolymers. As indicated previously, the surfaces achieved at the time were quite poor (Figs. 3A and B respectively),³ and understandably, the playback characteristics (Figs. 2A and B) were quite noisy. As molding and compound processing techniques were improved, but not yet optimized, surfaces such as shown in Fig. 12A were achieved. Some surface roughness is observable from the particulate filler in the base resin system, which appears to cause a 2-4 dB degradation in carrier-noise ratio from that observed on a coated, non-conductive compression

* Max peak-peak warp of 0.5 mm after 55°C for 48 hours.

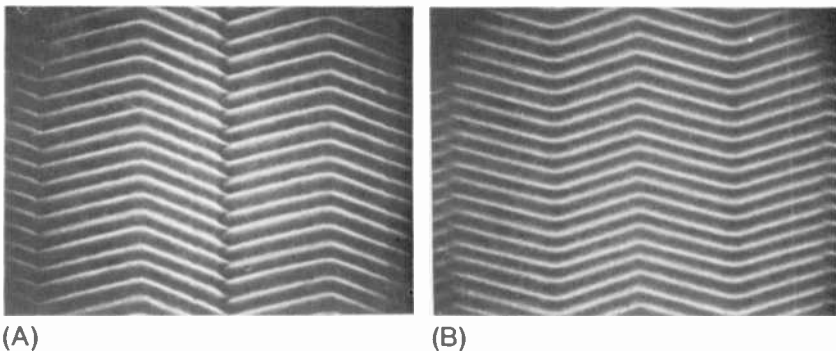

Fig. 11—(A) Surface of stamper from mechanically cut master and (B) surface of compression-molded unfilled disc from same stamper as in A. Magnification in both cases is approximately 5000X.

molded disc. Observed playback pictures were quite acceptable, however. As of this writing, improvements in compound processing and molding conditions have led to the achievement of surfaces such as shown in Fig. 12B. Playback performance is comparable to that of the coated disc.

Typical transmission electron micrographs of the 15% Ketjenblack formulation in a propylene-vinyl chloride copolymer can be seen in Fig. 13. Various carbon materials display different characteristics, as can be seen in Figs. 14 and 15. A 30% by weight loading of Cabot Vulcan XC-72 in a polyvinyl chloride/acetate copolymer (Fig. 14) displays large insu-

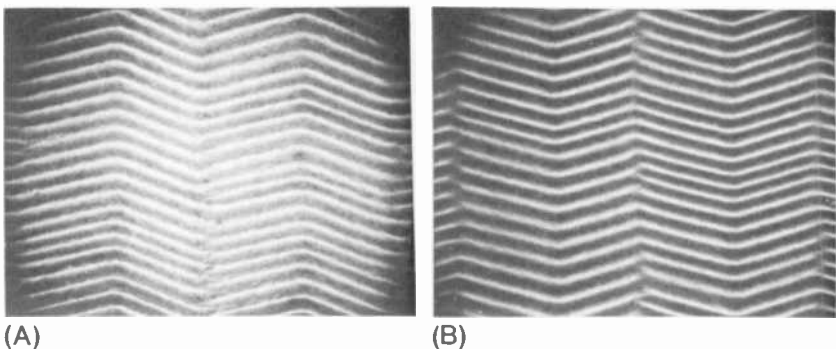

Fig. 12—(A) Replica of disc containing 15% Ketjenblack in a propylene-vinyl chloride copolymer compression molded from same stamper as in Fig. 11A and (B) surface of improved compound disc compression molded from same stamper. Magnification in both cases is approximately 5,000X.

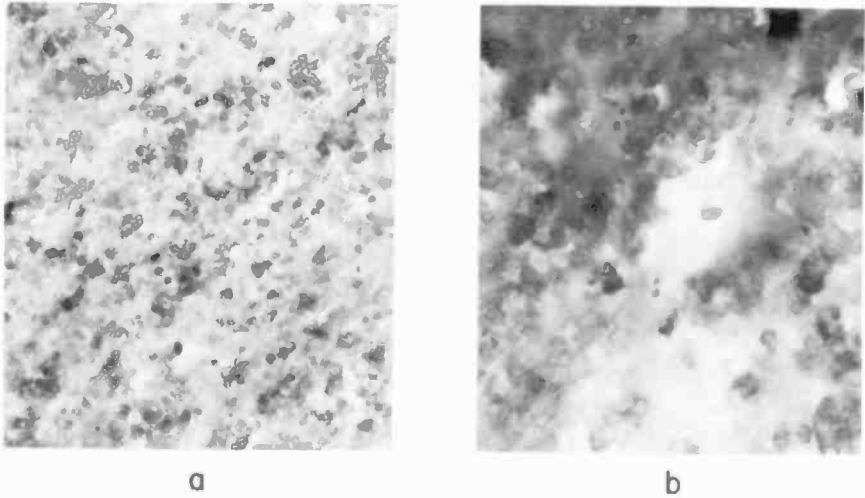

Fig. 13—Transmission electron micrographs of 15% by weight Ketjenblack EC in a propylene-vinyl chloride copolymer. Magnification of (a) is approximately 20,000X and that of (b) is approximately 50,000X.

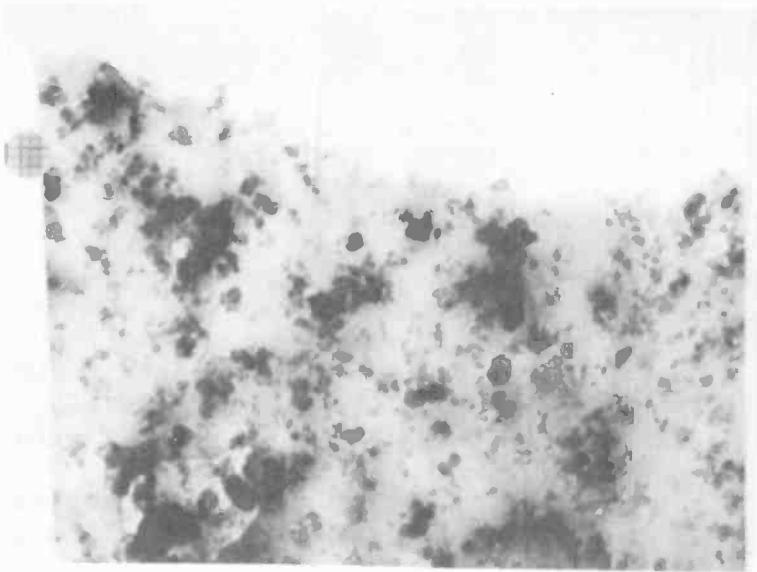

Fig. 14—Transmission electron micrograph of 30% by weight Cabot Vulcan XC-72 in polyvinyl chloride-acetate copolymer (magnification approximately 28,000X).

lating regions of unfilled polymer, which accounts for the poor conductivity and noisy playback with this formulation. Cabot's Mogul L (Fig. 15), on the other hand, displays excellent dispersion at a 30% by weight loading, but the conductivity is poor due to the high surface oxygen content (see below). The effect of low "structure", or degree of agglomeration, is also seen here.

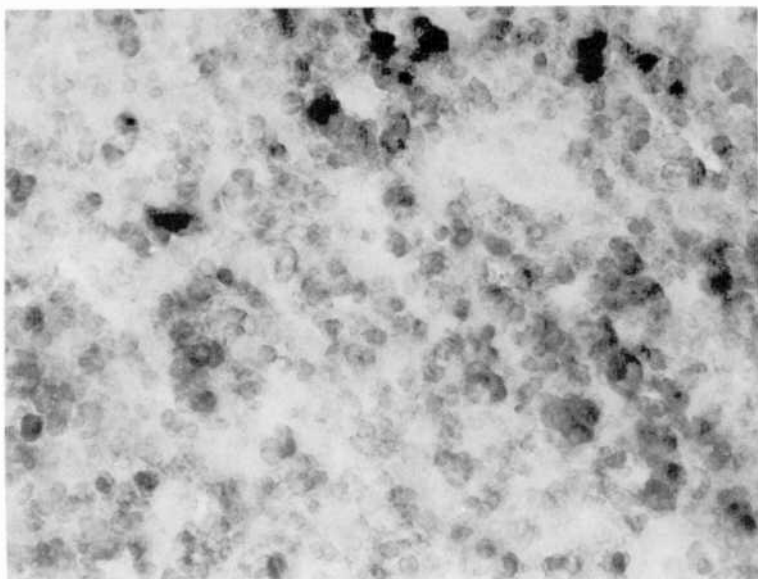

Fig. 15—Transmission electron micrograph of 30% by weight Cabot Mogul L in polyvinyl chloride-acetate copolymer (magnification approximately 65,000X).

2.2 Carbon Requirements

In general, most conductive carbon blacks are formed by the oil furnace process.²⁰ The properties of most interest are those that affect the conductivity, rheology, physical properties, and surface. They are:²¹

- (a) Nitrogen surface area—this is a measure of the porosity and therefore the particle density. A high surface area is desirable.
- (b) Oil absorption—a measure of the structure or the number of particles per aggregate.
- (c) Volatility—a measure of the oxygen-containing groups on the surface (hydroquinones, quinones, lactones, and carboxylic acids),²² which reduce the mobility of free electrons.
- (d) Particle size—this is difficult to define since most carbons consist of agglomerates of small particles. Optimum performance of the

Table 2—Properties of Representative Conductive Carbons

	Ketjenblack EC	Cabot Vulcan XC-72	Columbia Conductex 950
Oil absorption (ml/100g)	340	180	175
Nitrogen Surface Area (m ² /g)	1000	220	245
Volatiles (% by weight)	1	2.0	0.8
Particle Size (Å)	300	300	210

VideoDisc can be expected from well-dispersed, small particles.

Table 2 lists typical values of these properties for some representative conductive carbons. Playback performance of discs pressed from typical formulations can be seen in Table 3. Ketjenblack EC has been shown to be the most conductive carbon evaluated, and because of its large surface area, can be used in low weight percent loadings. This material is presently the preferred conductive carbon for use in the VideoDisc.

2.3 Mixing Effects

Since the structure of the carbon black is a measure of the agglomeration of the particles, the higher the structure, the more porous the aggregate and the smaller the interaggregate distance.⁶ Thus, one would expect that the higher the structure, the lower the resistivity at a constant loading level. As can be seen from previous data, this is indeed true. One would also expect that any mechanical stressing during processing, which would tend to break up these agglomerates, would lead to an increase in resistivity. This also has been shown to be true, within limits. An experiment was performed wherein a compound containing 15% by weight Ketjenblack EC was put through a Brabender extruder for the number of passes indicated in Fig. 16. As can be seen, within a small range, the resistivity goes through a minimum as the dispersion is optimized and then begins to rise as the agglomerates are broken up, surrounding more

Table 3—Performance Characteristics of Typical Formulations

Carbon	Wt. % Loading	Resistivity (Ω -cm)		Carrier Level mVpp	Inside (dB) at 5 MHz
		915 MHz	DC		
Cabot XC-72	35	29	360	3.2	40
Ketjenblack EC	15	2.9	5.0	6.5	47
Ketjenblack EC	9	710	∞	.095	34
Columbia Conductex 950	25	120	14,000	2.3	42

of them by insulating polymer films. Output signal, as measured by the carrier level, also appears to be similarly affected as can be seen in Fig. 17. Since carrier-to-noise ratio is less affected by small changes in resistivity in the range examined, it was shown to vary only 1–1.5 dB over the range examined.

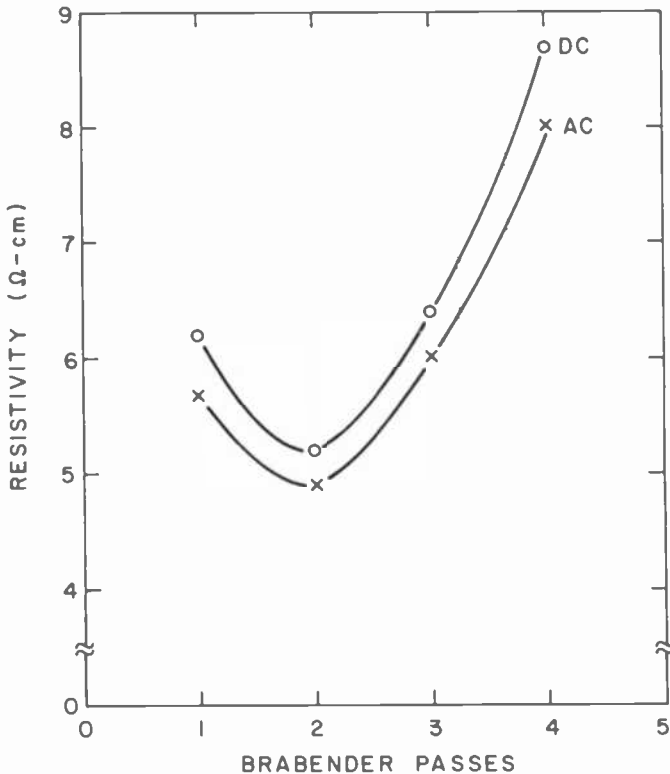

Fig. 16—Resistivity versus number of passes through Brabender extruder for 13% by weight Ketjenblack EC in a polyvinyl chloride-acetate copolymer system.

3. Advantages of the Conductive Disc

As indicated previously, the coatings on the capacitive discs had presented a unique set of problems that made the development of a commercial disc difficult. These coatings, which consisted of copper and/or nickel alloys, were particularly sensitive to environmental exposure. Adhesion of the metal coatings to the disc material was made particularly difficult by the fact that the molding compound, included lubricants,

are designed to provide good mold release. Additionally, the application of the vacuum-deposited metal and dielectric coatings required enormously complex equipment in order to scale-up to production quantities. Although the conductive disc described here has some of its own unique problems, such as increased complexity of the molding compound, the materials can be handled with standard polymer processing equipment, and the coating steps are eliminated. The net result is a less expensive, more stable, and simpler system capable of acceptable consumer performance levels. The simpler construction makes it possible to manufacture VideoDiscs using existing record-pressing capabilities, with a minimum of additional capital investment.

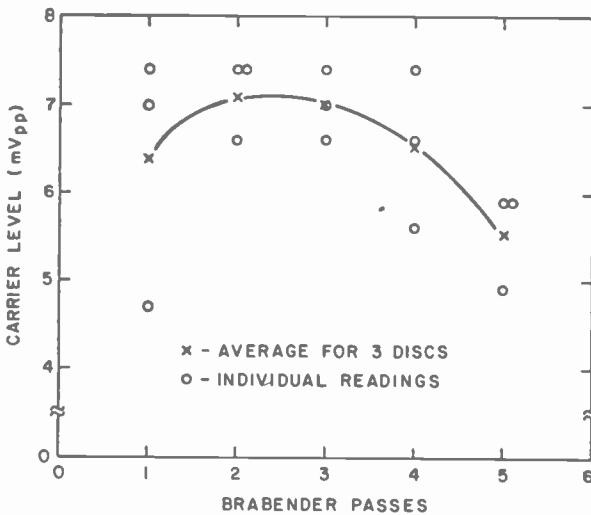

Fig. 17—Carrier-to-noise level versus number of passes through Brabender extruder for 13% by weight Ketjenblack EC in a polyvinyl chloride-acetate copolymer system.

4. Summary

RCA has successfully developed a conductive VideoDisc capable of performing with the capacitive system and requiring no coatings except for the lubricant. The material and process considerations relative to the development and achievement of acceptable performance levels have been described. It has been shown that a formulation consisting of 15% by weight Ketjenblack EC in a polyvinyl chloride homopolymer or a

propylene copolymer based resin system can be processed in commercial equipment to produce a VideoDisc capable of meeting environmental as well as performance requirements.

Acknowledgment

An achievement such as this can only be accomplished with the dedicated contribution of many people. In particular, this would not have been possible without the unselfish dedication of P. Datta, H. Kawamoto, and G. Danovsky of RCA Laboratories, Princeton, NJ, and R. J. Ryan of the Selectavision Record Engineering Group in Indianapolis. In addition, the following people all played major roles in the developments leading to a successful conductive VideoDisc: at RCA Laboratories, E. Allen, A. Arena, R. Auth, J. Berkshire, J. Bleazey, R. Cohen, M. Coutts, L. Di-Marco, F. Dixon, L. Ekstrom, R. Friel, J. Gittleman, J. Gibson, B. Hershenov, W. Lee, A. Levine, G. Lozier, D. Matthies, J. Reisner, S. Seffren, and E. Sichel; at RCA Indianapolis, K. Khanna, C. J. Martin, M. McNeely and M. Voelker. Many others, too numerous to mention, also contributed significantly to this program, and their efforts are deeply appreciated.

References:

- ¹ E. O. Keizer and D. S. McCoy, "The Evolution of the RCA 'SelectaVision' VideoDisc System—A Historical Perspective," *RCA Review*, **39**, p. 14, March 1978 (this issue).
- ² D. S. McCoy, "The RCA 'SelectaVision' VideoDisc System," *RCA Review*, **39**, p. 7, March 1978 (this issue).
- ³ D. L. Matthies, private communication.
- ⁴ L. P. Fox and P. Datta, "Conductive Disc," private communication.
- ⁵ Polley and Boonstra, "Carbon Blacks for Highly Conductive Rubber," *Rubber Chem. Tech.*, **30**, p. 170, Jan.-Mar. 1957.
- ⁶ Verhelst, et al, "The Role of Morphology and Structure of the Carbon Black in the Electrical Conductance of Vulcanizates," *Rubber Chem. Tech.*, **50**, p. 735 (1977).
- ⁷ R. H. Norman, *Conductive Rubbers and Plastics*, Elsevier Publishing Co., Ltd., New York (1970).
- ⁸ F. F. Hanna and A. M. Ghonheim, "Dielectric Properties of Rubber in the Microwave Region and Their Temperature Dependence," *Z. Phys. Chem. (Leipzig)*, **241**, p. 12 (1969).
- ⁹ L. K. H. VanBeek, "Dielectric Behavior of Heterogeneous Systems," in *Progress in Dielectrics* (Ed. J. B. Birks), Vol. 7, p. 69, CRC Press, Cleveland 1967.
- ¹⁰ H. Kawamoto, private communication.
- ¹¹ M. Mooney, *J. Colloid Sc.*, **6**, p. 162 (1951).
- ¹² L. E. Nielson, *Mechanical Properties of Polymers and Composites*, Vol. II, Marcel Dekker, Inc., New York (1974).
- ¹³ C. D. Han, *Rheology in Polymer Processing*, Academic Press, New York (1976).
- ¹⁴ P. Datta, private communication.
- ¹⁵ J. J. Gouza, J. V. Schmitz, and W. E. Brown Ed., *Testing of Polymers*, **2**, p. 225, Interscience, New York.
- ¹⁶ I. E. Neimark, et al, *SPE Trans.*, **2**, p. 135 (1962).

- ¹⁷ W. J. Frissel, *Plastic Technology*, 2, p. 723 (1956).
- ¹⁸ E. A. Noga and R. T. Woodhams, *SPE Journal*, 26, p. 23 (1970).
- ¹⁹ F. G. Krautz, *SPE Journal*, 27, p. 72 (1971).
- ²⁰ F. Spinelli, *Fundamentals of Carbon Black Technology*, *American Ink Maker*, Aug. 1970.
- ²¹ J. H. Smuckler and P. M. Finnerty, *Performance of Conductive Carbon Blacks in a Typical Plastics System*, *Advances in Chemistry Series 134*, ACS.
- ²² D. Rivin, "Surface Properties of Carbon," *Rubber Chemistry and Technology*, 40, p. 307 1971.

Coatings for VideoDiscs

D. L. Ross

RCA Laboratories, Princeton, N.J. 08540

Abstract—In this review, the research that led to the definition and realization of satisfactory production processes for the vacuum deposition of 200 Å layers of metal, dielectric, and lubricant suitable for coating RCA capacitive-playback VideoDiscs molded from insulating thermoplastics is described. These coatings had to meet extremely demanding criteria for strength, uniformity, smoothness, adhesion, and chemical stability. The processes developed utilized an integrated, three-section vacuum system capable of coating 12-inch discs at rates up to 1000 per hour with (1) a sputtered metal layer having a carefully defined graded composition, (2) a plasma-polymerized organic dielectric layer whose chemistry and physical properties were controlled by the geometry of the gas inlet system, the composition of the carrier gas, and the power density, and (3) a vacuum-evaporated silicone lubricant layer.

The criteria developed for this system pertained specifically to use of sapphire styli for playback of the coated discs. Experience gained from experiments with diamond styli led to the discovery of a simpler coating system not requiring a separate dielectric layer. Some aspects of the simplified metal/lubricant system for use with diamond playback styli are discussed.

Studies carried out to determine the minimum acceptable conductivity required of the metal layer for coated discs led to the realization that, through filling the thermoplastic with conductive carbon blacks, adequate substrate conductivity could be achieved without the need for a metal coating. This further simplification of the system leaves only the need for a lubricant. The approaches developed during the definition of coatings for the nonconductive disc provided guidance in the selection of lubricants for the conductive disc.

Introduction

As originally conceived and extensively developed, the capacitive-

playback VideoDisc was molded from a thermoplastic, and two elements of the variable capacitor (one "plate" and the dielectric) were provided by thin conformal coatings applied to the disc surface by vacuum deposition processes. A lubricant is also required in order to reduce wear of the disc surface and, especially, the stylus to a minimum. Although recent advances made in the technology of conductive carbon-filled molding compounds have permitted VideoDiscs to be fabricated that no longer require separate conductive and dielectric coatings, the research that led to the definition and realization of satisfactory production processes for the deposition of extremely thin (ca. 200 Å) coatings of well-defined composition and excellent stability is of sufficient interest to warrant this review.

The work to be discussed truly stretched the state of the art of thin film technology to its limits and has posed a number of questions in the fields of lubrication and tribology that are still unanswered. The production thin film vacuum coater used in this program is, to the best of our knowledge, the only factory apparatus ever developed for the large-scale deposition of plasma polymerized organic dielectrics. The knowledge and techniques developed during the research effort led to the recognition that carbon-filled plastic discs were feasible and have provided the basis for the selection and testing of the one remaining coating still required, the lubricant.

In this review, we first consider the properties required of the coatings and deposition processes. Each of the three layers is described: metal, dielectric, and lubricant. The evolution of a simpler system, not requiring a separate dielectric layer, is then discussed. Finally, lubrication of the carbon-filled conductive disc is treated.

Coatings Systems Requirements and Constraints

A set of *a priori* specifications can be developed for the coatings by examining the basic nature of the system in which they are to be employed. First, from the standpoint of electronic signal recovery (playback), the metal layer must be conductive, conformal and continuous, and free of any features (point defects, pinholes, grain structure) larger than perhaps 100 Å. The dielectric must insulate the stylus electrode from contact (shorting) with the metal layer, and it also should be smooth, continuous, and defect free. This layer must be as thin as possible because the signal strength and the system aperture response are both adversely affected in proportion to the separation between the stylus electrode and the disc conductive plane.

The requirements imposed by the mechanical properties of the system are considerably more severe. The stylus sliding rate is about 500 cm/sec

and its pressure is $1 - 2 \times 10^8$ Pa. It has been calculated that, due to elastic deformation of the disc, the stylus shoe rides in a depression as deep as 2500 \AA whose intersection with the undistorted disc surface has an extremely sharp radius of curvature (see Fig. 1). The coatings are subjected to severe impacts whenever the stylus is set down or encounters point defects. Accelerations produced by disc warp or "orange peel" roughness add to the stylus pressure. The coatings must possess high cohesive strength and adhere tenaciously to one another and to the substrate in order to withstand these forces. The pressures and shear forces involved lead to the need for a lubricant. It must form a thin continuous film that inhibits intimate contact between the stylus and the dielectric layer to prevent wear of these two surfaces.

A subset of *a posteriori* physical requirements were derived as the result of an extensive analysis of the principal VideoDisc playback failure mode, which is strongly dependent on the properties of the coatings. This failure mode is the loss of recovered signal caused by the physical separation of the stylus from the disc surface when particulate matter accumulates either at the base of the stylus or under the stylus shoe. There are several sources of this stylus-lifting material: small point defects in the molded disc surface or embedded in the coatings will be sheared off by the stylus; if the stylus is chipped, or if it experiences a sudden acceleration, it may dig into the coatings and shave off material; as a result of play-induced coatings stresses or because of chemically induced loss of cohesion/adhesion, particles of the coatings can flake off; dust particles of a variety of sizes, shapes, and chemical composition will settle on the disc surface. In many cases, the stylus will push these various particles

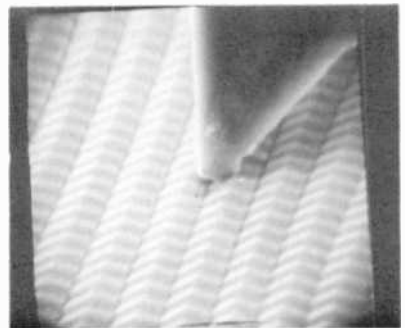
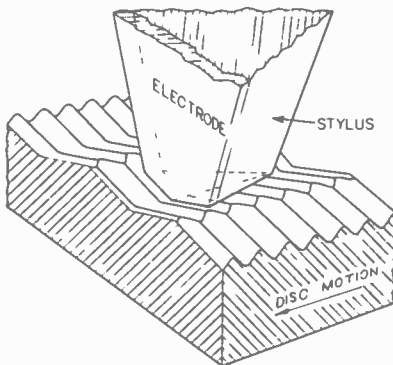

Fig. 1—Left: Schematic drawing of the capacitive stylus in a groove on a VideoDisc. Right: Scanning electron micrograph showing the trailing (electrode) edge of a diamond stylus on a 9524 groove-per-inch electromechanically-mastered (V-groove) disc.

aside, but, in some cases, an accumulation of them will build up around the stylus, held together by mechanical or electrostatic forces and/or the wetting action of the lubricant. Such accumulations can become spontaneously detached or they may build up to the extent that they engulf the end of the stylus and lift it. In the most severe cases, particles can become wedged between the disc and the stylus "prow." They then have a high probability of becoming interposed between the stylus shoe and the surface, whereupon they lift the stylus (loss of signal strength) and, because of the extremely high pressures, cut the coatings (generating more particles) as they are dragged along. The high pressures produced can literally weld the particle to the stylus shoe resulting in extensive disc damage and disablement of the stylus. It was experimentally demonstrated that particles 2-5 μm in size were more likely to cause stylus lifting than were particles 1 μm or smaller. Particles 20-30 μm in size cause locked and skipped grooves.

To protect the system from this mode of failure, the dielectric should have high cohesive strength and adhere well to the substrate. The lubricant should prevent adhesion of particulate matter to the stylus shoe and of dust particles to the disc surface. The dielectric layer should, if detached, break up into submicron-sized particles.

The deposition processes and chemical composition of the coatings must be chosen to produce the properties discussed above. The metal layer must be amorphous. Its adhesion to the extremely smooth disc surface will be dominated by van der Waals and electrostatic forces and will require low intrinsic stresses. The dielectric surface energy and the surface tension of the lubricant must be compatible to ensure good spreading and retention of a permanent film.

Once the desired properties are achieved, they must have high intrinsic stability and must resist the chemical and physical stressing the disc will experience in the field. Extremes of temperature and humidity are encountered in many parts of the country (Fig. 2) and they have been shown to accelerate or change the courses of chemical reactions inherent in certain coatings. Of greater significance is the highly corrosive nature of atmospheric pollutants, salt air, fingerprints, and ordinary house dust. Dust was found to have a particularly malignant effect on VideoDiscs. Many of the components of ordinary house dust have a high content of inorganic salts. At a relative humidity of about 80%, these particles, when resting on a surface, absorb enough moisture, by a combination of capillary forces and the hygroscopic nature of the salts, to cause a fluid solution of the salts to form around them. When the humidity later drops, this pool of salts dries out, leaving the dust particles firmly adhered to the surface (Fig. 3). These adhered particles cause locked and skipped grooves on playback of VideoDiscs and serve as a source of particulate

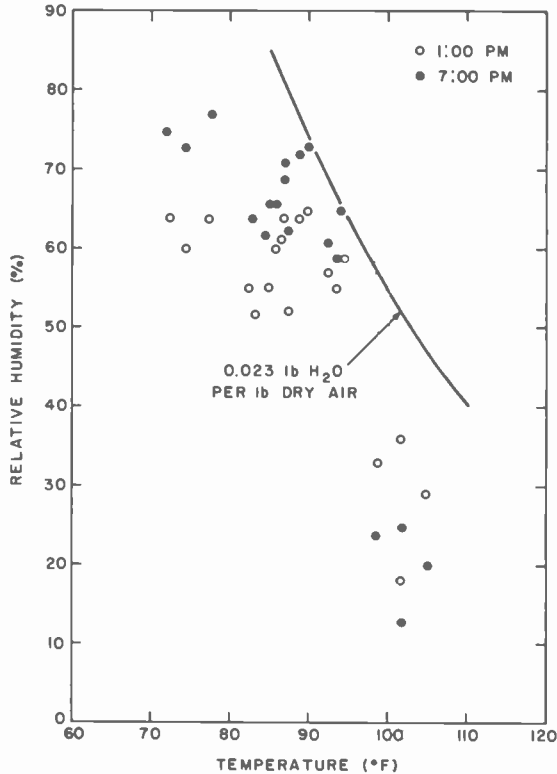

Fig. 2—The average daily maximum temperatures for the 3 hottest months versus the average relative humidity for each of these months at 1:00 PM (open circles) and 7:00 PM (filled circles) for six cities in the U.S. (Atlanta, Baltimore, Houston, Miami, Phoenix, and San Diego). The solid curve shows the relative humidity versus temperature for an absolute humidity of 0.023 pound of water per pound of dry air. This curve served as a basis for establishing certain coatings stress tests. For example, 85°F and 90% RH is used for accelerating the corrosive effects and adhesion of applications of controlled quantities of house dust.

material. In addition, the salts eluted are rich in chloride and sulfate ions and are, thus, capable of attacking a susceptible metal layer.

The methods used for deposition of the coatings affect to first order the choice of materials and their properties. The decision to utilize an in-line continuous vacuum system for production deposition of all three coatings had a profound influence on the selection of materials to be used. This equipment was designed for a continuous throughput at a rate of 720–1000 discs per hour. The deposition rates used were at least ten times those achieved in laboratory bell-jar systems. All three coatings processes were in line, the only isolation between them being provided

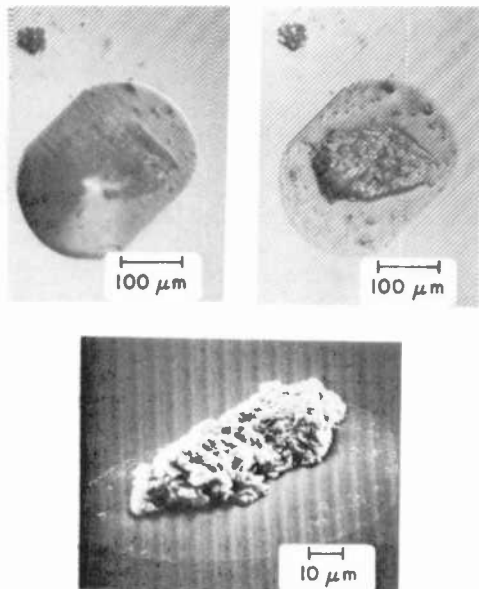

Fig. 3—Optical photomicrograph of a dust particle on a coated VideoDisc surface examined in a high-humidity ambient (top left). The particle is surrounded by a liquid droplet formed by deliquescence of salts borne by the particle. Note that the smaller particle, of different composition, remains dry. Within 30 sec of reducing the ambient humidity (top right), the water evaporates leaving a stain comprising water-soluble components eluted from the particle. Bottom: Scanning electron photomicrograph of a similar particle on a VideoDisc surface following exposure to high humidity. Note the surrounding stain. Capillary forces tend to limit the spread of the liquid droplet to directions parallel to the grooves.

by narrow tunnels that separate the chambers and some pumping at the tunnel positions (Figs. 4 and 5). As a consequence, the entire coater had to operate at an internal pressure of about 5–10 millitorr. This pressure was dictated primarily by the metal sputtering process. Efficient metal and dielectric deposition processes were required because the power that could be dissipated in these two chambers was limited by the thermal distortion (warping) temperature of the discs. Some flexibility was possible in terms of the number of kinds of metal electrodes that could be fitted, although the choice of metals was limited to those available in large ($26 \times 14 \times 1$ inch) slabs. Plasma polymerization of organic monomers was chosen as the dielectric deposition process. The space available and the number of electrodes that could be accommodated in the dielectric chamber permitted considerable variations among deposition rate and power density. Obviously, a lubricant that could be deposited by vacuum evaporation had to be chosen. The permissible

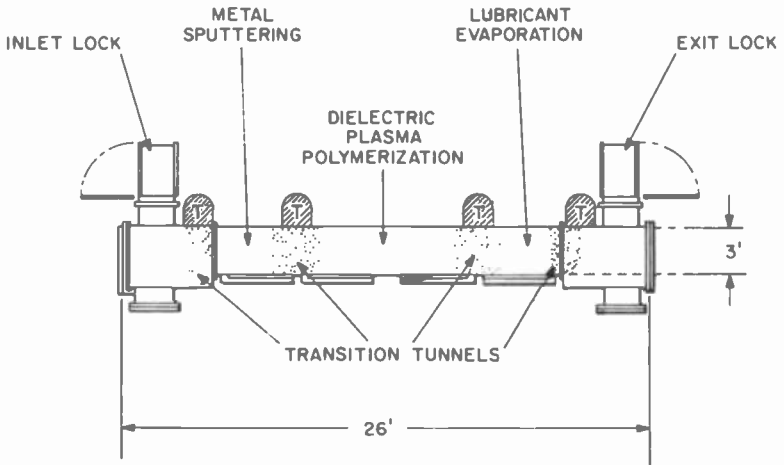
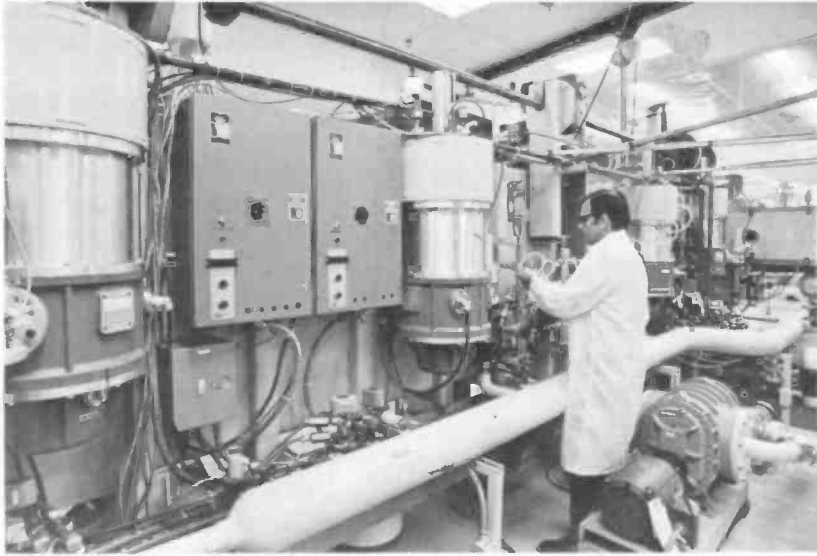

Fig. 4—Schematic horizontal-section view of the production in-line vacuum coater. Stokes mechanical pumps were used to pump from atmospheric pressure to 1 Torr. Roots Blowers provided pumping from 1-0.1 Torr. Turbomolecular pumps (shown as "T" in this diagram) pumped to about 10 millitorr. The coater was loaded with racks containing 48 discs. After passing through a vacuum lock, the racks were unloaded. The discs were passed through the coater in an upright position at a rate of 720 per hour and then reloaded into racks at the exit end for removal.

pressure differentials between chambers were quite limited in that it was necessary to prevent cross contamination of gases and organic materials between the metal and dielectric processes and, similarly, of oil vapors and organic monomers between the dielectric and lubricant processes.

The pumping capacity of the coater was designed to deal with only a small amount of disc outgassing and the relatively modest flow rates of argon (sputtering process) and carrier gas (dielectric process). The dielectric deposition chemistry was believed to be nearly static, i.e., the monomer was expected to be essentially all consumed and deposited on the discs, electrodes, and chamber walls. The turbomolecular pumps were not very efficient for hydrogen removal. Two somewhat unanticipated factors affecting pumping dynamics were discovered early in the operation of the coater: under the high-energy conditions that pertained in the sputtering chamber the discs outgassed more than had been expected, and an appreciable amount of hydrogen is produced on plasma excitation of most organic monomers. On the other hand, some flexibility was possible in the placement of gas inlet positions and, thus to some extent, the directions of gas flow through the chambers. Internal baffling for further refinements of the paths of gas flow was also possible.



A



B

Fig. 5—(A) View of the "back" side of the coater showing the four turbomolecular pumps. (B) View of the "front" side. A mass spectrometer head is attached to a port in the dielectric chamber. The control panels for the coater are seen at the left.

Finally, it must be stated that an "optimum" coating can only be defined with reference to the disc substrate to be coated and the stylus used to play the coated discs.

The thermoplastic from which the disc is molded, and the specific molding conditions, will influence the performance of the coatings. All the discs used in this program have been pressed from resins based on poly(vinyl chloride). This material thermally liberates HCl during compounding and pressing and, it was found, evolves additional HCl under the influence of the high ambient radiation and particle bombardment during vacuum deposition of metal and dielectric layers. Indeed, analyses found high concentrations of chloride ion at the disc/metal interface and, in many cases, at the metal/dielectric interface. These trapped chloride ions influenced the corrosion resistance of the metal layers. The modulus of the molded disc, and molded-in stresses at the surface, determine the depth and radius of curvature of the stylus-induced deformation and, thus, the degree to which the coatings are stressed on playback. Asperities formed during molding will generate particulate matter when sheared off by the stylus. Certain materials added to the compound to aid its processing can migrate to the disc surface and influence the adhesion of applied coatings.

The stylus plays a most significant role in the specification of an acceptable coatings process. The material of which it is made will determine its wear rate and the degree to which the lubricant, or particulate matter, can adhere to it. The stylus shape is the primary determinant of how readily material will become trapped between the shoe and the disc surface. The stylus tracking force and pressure will influence the degree to which the coatings are stressed. The coatings system developed in the work to be described was oriented toward the use of sapphire as the stylus material.

With the orientation provided by the foregoing discussion, we shall now examine the conductive metal, dielectric, and lubricant coatings in some detail. Their evolution from laboratory to production processes and the influence of the production coater on the coatings properties will be treated. Finally, two improved and simplified disc/coatings systems that emerged as a result of the knowledge gained during development of the coatings processes are described.

The Conductive Layer

Initially, VideoDiscs were metallized by vacuum thermal evaporation of aluminum. Much of the original development of the dielectric and lubricant coatings was done using this substrate. A resistivity specification of 10 ohms per square was set to meet the electrical requirements

of the dielectric deposition process. As the mastering and disc pressing processes improved, it was found that the inherent roughness (grain structure, point defects) of evaporated aluminum was responsible for some electronic noise in the recovered signal on playback. The substitution of evaporated gold led to an improvement of several dB in playback signal-to-noise ratio, and this was used for some time as the laboratory standard metal layer, although it was recognized that cost considerations would preclude the use of gold coatings for a commercial product.

The choice of a metal for the conductive layer was influenced to a great extent by the manufacturing process to be used for its deposition. Because of its efficiency and relatively low thermal contribution, planar magnetron sputtering was decided upon as the metal coating process in the production vacuum coater. Changes in the electrical configuration of the dielectric deposition process (see below) permitted the resistivity specification to be relaxed to 600 ohms per square. The low materials cost, ease of application by sputtering, and the good adhesion characteristics of copper led to its extensive evaluation as the metal layer. Copper, however, has two drawbacks: the grain size is large (sizes greater than 1500 Å were observed, with an average size of 400–500 Å, see Fig. 6), and, of considerably greater significance, it is extremely prone to corrosion. Fingerprints led to rapid deterioration of copper layers, and storage for one week in a seashore residence rendered copper-coated discs unplayable. Further, as treated in the discussion of the dielectric layer, there was evidence that, when deposited on copper, the dielectric and its metal interface underwent spontaneous changes on storage even in a relatively benign environment.

A search for a corrosion-resistant replacement for copper having a reasonable sputtering rate was begun. An H_2S - H_2O -air exposure test was used for screening candidates. An 80/20 Ni/Cr alloy (Nichrome V) exhibited excellent properties, but it was not available in the one-inch thicknesses needed for fabrication of electrodes for the production coater. Inconel 600 (a 76/16/8 Ni/Cr/Fe alloy) was chosen for system tests. While sputtered layers of this material were amorphous (Fig. 6) and performed well on corrosion tests, their adhesion to the poly(vinyl chloride) discs, and the adhesion of the organic dielectric layer to them, were found to be unsatisfactory, especially following high-temperature/humidity stressing. An analysis of this problem led to the realization that adhesion at these interfaces could be obtained by creating high electrostatic forces at the two surfaces and reducing the intrinsic stress within the metal layer to a minimum. Measurements made on Inconel films coated in a laboratory sputtering system showed the stress to be of the order of 10^{10} dynes/cm², and it was anticipated that, at the ten-times greater deposition rates in the production coater, this value would be even higher.



A. TEM OF SPUTTERED
COPPER

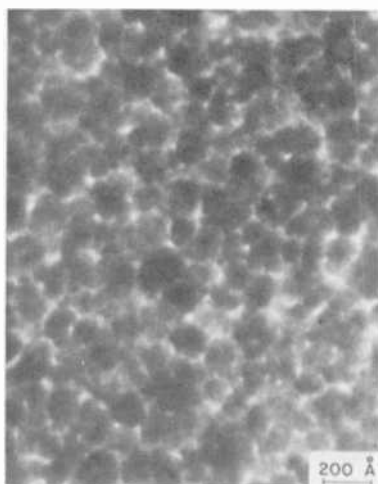

B. TEM OF SPUTTERED
INCONEL 600

Fig. 6—Transmission electron micrographs of sputtered metal layers: (A) copper shows a coarse grain structure. (B) Inconel shows an extremely fine grain structure.

The desired electrostatic forces were achieved by depositing a very thin ($<50 \text{ \AA}$) layer of a free (unoxidized) metal at both interfaces. Copper was chosen for this metal because the free energies of formation of the oxides of Ni, Cr, and Fe assured that, even if the bottom copper layer were to become oxidized during deposition, it would subsequently be chemically reduced during the formation of the Inconel layer. Similar arguments suggested that, during deposition of the dielectric, reduction of any oxide in the top copper layer would occur, and, indeed, ESCA measurements established this to be the case.

The stress relief was obtained by incorporation of some 20–30 atomic percent of oxygen in the Inconel layer through the introduction of carefully controlled amounts of oxygen into the sputtering chamber. The oxygen was efficiently “scavenged” by the sputtered metal. This served to convert all of the chromium and iron, and much of the nickel, to their oxides. A similar approach that was investigated involved co-sputtering copper and Inconel in an argon-oxygen atmosphere so as to produce a layer of Inconel containing 12.5 atomic percent copper plus 20 atomic percent oxygen. This latter approach was not pursued, however, because it was realized that co-sputtering would be difficult to achieve in the production coater and a cast “alloy” of 12.5 percent copper in Inconel would be quite brittle due to segregation of the copper.

As was expected, the “trilayer” composition gave excellent adhesion

at both interfaces, but this drastic modification of the metal layer chemistry reduced its corrosion resistance as compared with simple Inconel coatings, largely as a result of the presence of the top layer of copper. Further, rather high local concentrations of chloride ions were found at the disc/copper interface. This is a consequence of the HCl formed on bombardment of the poly(vinyl chloride) substrate by high-energy particles and radiant energy during the sputtering process, plus the outgassing from the disc of HCl formed during the compounding and molding operations.

An extensive set of tests showed that the resistance of trilayers to H₂S corrosion is proportional to the distance of the chloride ion layer from the surface and the square of the oxygen content of the Inconel layer, and is inversely proportional to the amount of chloride ion present at the metal/disc interface and the thickness of the top copper layer. Thus, the corrosion resistance is seen to be a steeply rising function of the oxygen content. From the standpoint of this test, then, the optimum trilayer would contain about 30 atomic percent oxygen and no more than about 25 Å of copper at the top surface.

The trilayer metal composition, principally because of the superior adhesion achievable, was adopted and used for over a year, including the first six months of operation of the production coater. During this period, many thousands of VideoDiscs were coated and subjected to extensive testing in the laboratory and the field. It became apparent that these coatings also were characterized by time-related deterioration of the dielectric layer. The top layer of copper was active in catalyzing chemical reactions in the thin organic film, and outward migration of copper ions through the dielectric was taking place. Moreover, a corrosion mechanism different from that of H₂S was identified. Salts, especially chlorides, from fingerprints and from the deliquescent components of certain dust particles, attacked the coatings and caused adhesion failure at the dielectric/metal interface. At least part of this latter corrosion took place through an electrochemical reaction—the trilayer in contact with an electrolyte (salts) was found to produce an emf. The metallic copper was being oxidized and, thus, the "adhesive" for the dielectric was destroyed.

After an unsuccessful attempt to substitute Monel 400 (65/35 Ni/Cu) for the top copper layer, it was decided to eliminate this layer entirely and work with a "bilayer" consisting of 25–50 Å of copper under about 200 Å of Inconel/oxygen. This put the requirements for corrosion resistance and stress relief (high oxygen content) and those for adhesion of the dielectric layer (free metal at the surface) in direct conflict. The elimination of the top copper layer permitted a reduction in the amount of oxygen needed for corrosion resistance, but it was to impose a greater

burden on the design of both the bilayer and the dielectric layer in terms of achieving good adhesion at this interface.

It was through work on the bilayer deposition process that one of the advantages of the production coater was recognized. The flexibility of the gas inlet/flow configuration provided a needed refinement required for improving metal/dielectric adhesion. It was desired to provide free (unoxidized) metal at the surface of the bilayer coating. By locating the oxygen inlet at the very "front" (near the copper electrode) of the sputtering chamber, a high peak oxygen content in the Inconel layer could be obtained with a skewed distribution such that the maximum was positioned in the bottom half of the coating, leaving a high concentration of unoxidized nickel at the surface (Fig. 7). Thus the oxygen needed for stress relief and corrosion resistance could be introduced while providing for electrostatic bonding of the dielectric.

This measure, in conjunction with a similar adjustment in gas flow to be discussed in connection with the dielectric layer, served to increase the metal/dielectric adhesion to the point where it passed the most severe tests.

The Dielectric Layer

The requirements that the dielectric layer should be thin, conformal, and defect-free would seem to dictate that it be applied by a vapor deposition process. Some early experiments were performed on metal oxide dielectrics formed by anodization of appropriate metal layers. Electron-beam-evaporated poly(tetrafluoroethylene) was examined but was found to be too soft, as were other noncrosslinked organic materials. Although it was shown that acceptable dielectric films could be produced by the spinning on and curing of certain ultraviolet-crosslinkable resins, the majority of the research done involved the plasma polymerization of organic monomers (glow discharge polymerization).

In this process, the vapors of the monomer are introduced into a vacuum glow discharge. Upon bombardment by high-energy charged particles and, to some extent, by the radiation present (e.g., ultraviolet), the monomer molecules are excited to ions and radicals that recombine to form a crosslinked amorphous film whose composition and chemical and physical properties are influenced by the specific deposition conditions (e.g., monomer, carrier gas, pressure, substrate, power). During the development phase, these coatings were applied in bell-jar vacuum systems. The metal-coated discs comprised one electrode of the electrical circuit (hence, the early metal conductivity specification). After a pump-down, a measured quantity of monomer was introduced, the chamber was back-filled with air to a pressure of approximately 500

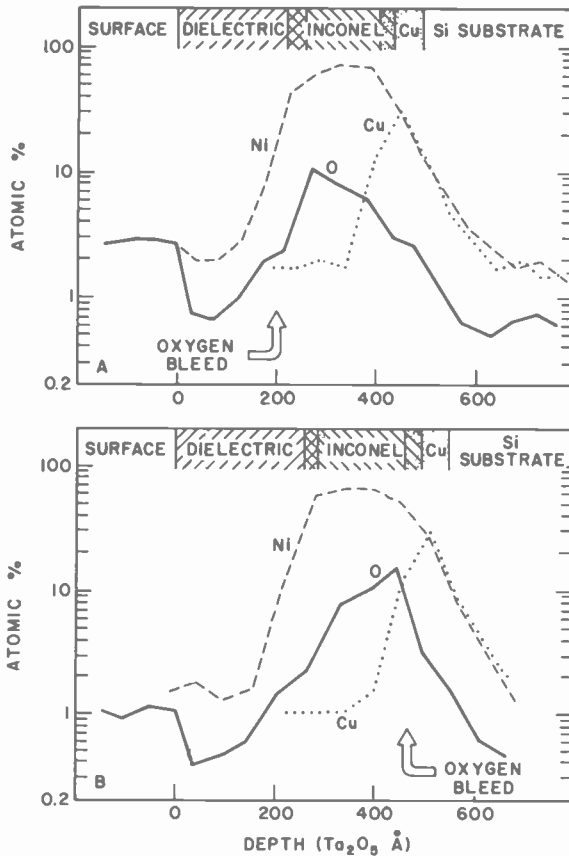

Fig. 7—Auger depth profiles showing the oxygen content (solid lines) of Inconel coatings sputter deposited on thin layers of copper in the presence of oxygen. A change in the position of the oxygen gas inlet from the exit end of the chamber (A) to very near the copper electrode (B) produced a skewed oxygen concentration profile. This permitted the incorporation of the desired average oxygen content while retaining some free (unoxidized) nickel at the metal surface. The data were taken using a PHI Mod. 540A Thin Film Analyzer with a $2 \mu\text{A}$ $0.7 \times 1.2 \text{ mm}$ defocused 3-keV electron beam at a 30° angle of incidence. Sputtering (ca. $30 \text{ \AA}/\text{min}$) was done with a 2-keV Ar^+ beam at 5×10^{-5} Torr. The thicknesses were calibrated against the measured sputter rate of Ta_2O_5 films.

millitorr, and a glow was initiated and maintained for a specified period of time. Depending on the rate at which the monomer was consumed, the coatings were thereby subjected to the effects of continued bombardment ("post-glowing") by excited species and radiation after the deposition of material had stopped. A brief investigation indicated that power frequency up to 20 kHz did not influence the coatings, and 60 Hz was chosen as standard.

The coatings produced were characterized principally in terms of physical durability, i.e., a stylus was placed on a slowly rotating disc and its force was increased until the film failed. Inspection of the scratch produced gave an index of the softness–brittleness of the coating. Multiple-play wear tests were also conducted. Styrene was found to be the most useful monomer, especially from the standpoint of the deposition rates achievable. Films produced from styrene showed good durability and adhered well to the metals then of interest (Al, Au, Ni). This “high pressure” process was used to produce the standard laboratory dielectric layer for several years.

The design considerations for the production vacuum coater required profound revisions of the standard glow discharge process. It was not feasible to make electrical contact to the disc as it passed through the system, and the chamber pressure was of the order of 10 millitorr. It was expected that nitrogen or argon would be used as the carrier gas, and, since the coating process itself was continuous, the introduction of monomer had to be continuous, thereby eliminating any beneficial effects of “post-glowing.” To produce a stable glow and to confine the active species to a region near the disc, magnetron electrodes were used. Coatings made in bell-jar systems using these conditions were found to be markedly different from those made by the standard laboratory process. They showed poor adhesion to gold and nickel surfaces, although freshly prepared films had good adhesion to copper. It was soon found that these films, especially when deposited on copper or “trilayer,” changed their chemical and physical properties on storage, leading to severe deterioration in playback of coated discs.

Analysis of the deterioration mechanism showed that several significant processes were operating. On copper substrates, there was a slow migration of this element, accompanied by chloride ion, through the dielectric film to the surface. The migration rate was accelerated by exposure to high temperature and humidity. The organic films themselves changed in chemical composition with time: oxidative reactions led to the incorporation of oxygen and the formation of polar functional groups (hydroxyl, carbonyl). There were concomitant changes in the surface energy. These changes resulted in loss of adhesion of the dielectric to the metal layer, loss of film strength (cohesion), and a decrease in lubrication efficiency due to changes in surface chemistry. The consequences were disc wear and the generation of particulate matter.

A detailed investigation of the new “low pressure” deposition process was carried out to explore the influence of monomer, carrier gas, carrier gas/monomer ratio, deposition rate, power density and frequency, gas inlet and electrode configurations, and thickness on the chemical and physical properties of the coatings. These properties, in turn, were cor-

related with the stability of the coatings to accelerated stresses and "natural" changes with time.

A large number of different monomers was investigated. With those that contained only carbon and hydrogen, no significant monomer-dependent differences were seen in the composition of the films produced. Infrared spectroscopy showed that deposits made with styrene contain few remaining aromatic groups, suggesting that the plasma fragments the monomer molecules into very small units. In general, it was found that the monomer must be highly unsaturated to obtain satisfactory deposition rates. Two potential replacements for styrene were identified. Acetylene is capable of giving extremely tough, durable dielectric coatings. Plasma polymerization of a number of organosilane materials in appropriate reactive carrier gases was found to give, on room-temperature substrates, continuous, near-stoichiometric hydrated layers of SiO_2 . While dielectric layers fabricated from these two materials have good mechanical and chemical stability, they produced high stylus wear rates. In addition, it was difficult to deposit them with the necessary rates in the production coater without compromising their physical properties. Styrene remained the most useful monomer.

The carrier gas, and the carrier gas/monomer ratio, are major determinants of the properties of the dielectric film. When present in the plasma, oxygen, nitrogen, and water become incorporated into the chemical structure of the deposit. Films prepared in the presence of oxygen and water contain molecularly bound oxygen as hydroxyl, carbonyl, and ester groups that are readily detected by infrared spectroscopy. Nitrogen, when used as the carrier gas, is also incorporated (amine, amide, nitrile groups). Freshly prepared films using air or argon as the carrier gas contain unsatisfied bonds (free radicals) that can be detected by electron spin resonance. Peroxides are also formed in the presence of oxygen. On subsequent heating of the films, they produce additional free radicals. These can gradually react with atmospheric oxygen and water, resulting in chain scission (less crosslinking, poorer cohesion) of the coating and the incorporation of additional polar groups.

The use of nitrogen as a carrier gas leads to a number of beneficial effects. The formation of free radicals is inhibited. The polar component of the surface energy can be controlled by the amount of nitrogen incorporated in the film which, in turn, is a function of the nitrogen/monomer ratio used. Film polarity influences both the adhesion to the metal substrate and the compatibility of the lubricant. Probably because of the greater resistance against hydrolysis of amide and nitrile functions, films made with nitrogen are considerably more stable toward high-temperature/humidity stressing and natural aging processes. Finally, the degree of chain branching in the polymeric deposit can be reduced

by adjustment of the nitrogen/monomer ratio. Tertiary carbon-hydrogen bonds (C_3C-H) are more susceptible to atmospheric oxidation than are primary and secondary bonds ($C-CH_3$, $C-CH_2-C$). It was experimentally determined that, from the standpoints of adhesion to Inconel (electrostatic forces) and good wetting/spreading by the lubricant (surface energy), the nitrogen content of the dielectric film should be about 4–5 atomic percent (as determined by Auger electron spectroscopy). For chemical stability, the oxygen content should be as low as possible.

At a given deposition rate, an increase in the power density produces tougher less permeable films (more crosslinking, better cohesion). At a constant monomer introduction rate, increasing the power density increases the deposition rate. Disc wear testing indicated that the maximum power level compatible with thermally induced disc warp should be used, and the final production process employed 3.25 kW of power using two electrode pairs. During prolonged coatings runs, a film of dielectric builds up on the glow discharge electrodes. To couple the electric field through this layer and to prevent its breakdown with concomitant arcing and fragmentation of the electrode deposit, thereby producing debris, it is necessary to use a high-frequency power supply. A frequency of 10 kHz was adopted, and subsequently a 1 MHz supply was used on the production coater. It was found that, if the monomer is introduced directly into the discharge, gas-phase polymerization can take place, resulting in the formation of fine particles that become embedded in the dielectric layer, producing many point defects. This phenomenon was prevented by permitting the monomer to mix well with the carrier gas and causing it to diffuse into the active region as it is consumed.

The optimum thickness of the dielectric layer was bracketed by consideration of several of the findings of this study. A lower limit was established by the observation that approximately 155 Å is required to obtain complete coverage of the metal layer. The rate of copper ion migration through a given coating type was shown to be proportional to the amount of copper in the top layer of "trilayer" and inversely proportional to the square of the dielectric thickness. The film should be as thick as possible to reduce to a minimum migration through it of materials that will attack the metal layer. However, because of built-in stresses, adhesion of the dielectric film decreases with increasing thickness and, from the standpoint of playback signal quality, the dielectric layer should be as thin as possible. A thickness of 200–250 Å was chosen as the best compromise.

Styrene dielectric coatings made in the production in-line system were observed to have several significant differences from those made by bell-jar batch processes. One difference is that the much higher deposition

rates produced films that were vastly superior to any made in bell jars. They were more durable and less permeable: when coated on trilayer, the rate of copper migration through a given film thickness was about 10% of that seen with an otherwise identical bell jar coating. Another difference is that since, in the production coater, the surface of the freshly prepared dielectric film is not exposed to air and moisture prior to deposition of the lubricant, the number of oxygen-containing polar groups formed was less and there were no free radicals detected. Apparently, at least some of the oxygen-containing functional groups found in bell-jar dielectrics are formed by reaction of air and moisture with the free radical-rich films as they are removed from the bell jar. It was also shown that the deposition of lubricant on the freshly formed dielectric film, while still in the vacuum system (no exposure to air), served to quench any free radicals present. Thorough rinsing of discs oiled in the production coater left a slight residue of silicon. This suggests that the quenching mechanism can result in some chemical bonding of the lubricant to the dielectric surface. As a consequence of these improvements in dielectric film chemistry, the production styrene coatings deposited on bilayer showed only small time-related changes in their properties on storage.

The final refinement in the production dielectric deposition process, which permitted the achievement of maximum styrene/Inconel adhesion, was introduced after examination of Auger depth profiles of the dielectric layers being produced. This examination showed that the concentration of nitrogen was not uniform through the film. Toward the surface, the concentration increased to give greater than the desired polarity needed for compatibility with the lubricant. A flat nitrogen profile was produced by positioning the monomer inlet at the end of the chamber, near the final electrode pair. A monomer concentration gradient was produced, raising the nitrogen/styrene ratio at the entrance end of the chamber so as to assure the proper concentration at the interface (Fig. 8).

These steps led to processes that produced adherent dielectric films of good physical and chemical durability having a surface energy of the proper value to be compatible with the lubricant.

The Lubricant

A lubricant is necessary for coated discs to prevent intimate contact between the stylus and the disc surface. With the most durable dielectric coatings, the principal benefit derived from lubrication is the reduction of stylus wear. Ideally, a lubricant will provide a nondestructive mechanism for dissipating the high shears involved as the stylus slides in the groove. With sufficiently thick layers of lubricant, the liquid film will

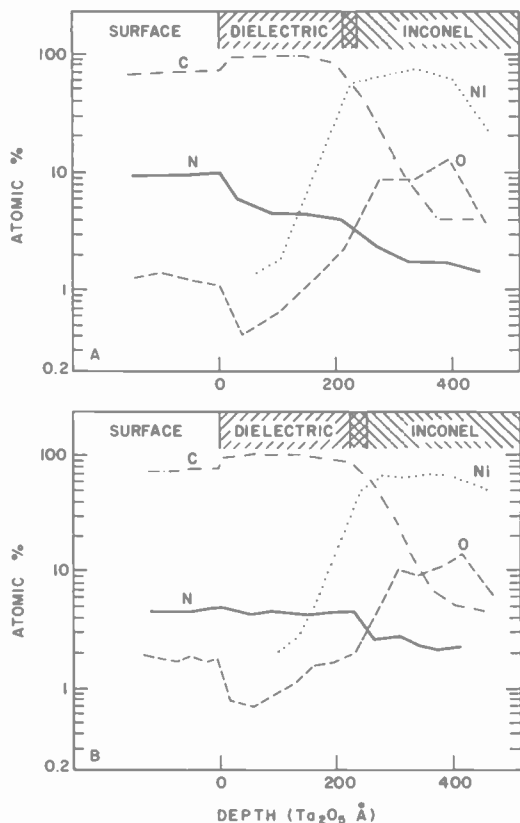
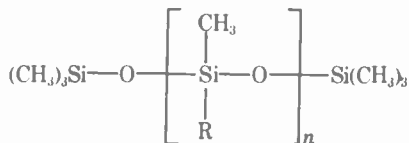

Fig. 8—Auger depth profiles of the nitrogen content (solid lines) of two organic dielectric films deposited on oxygenated "bilayer" (see text) by plasma polymerization of styrene in a nitrogen carrier gas. In (A) the monomer inlet is positioned near the center of the deposition chamber. The nitrogen content drops from about 10 atomic % at the surface to about 4 atomic % at the dielectric/inconel interface. In (B) the monomer inlet is positioned near the exit end of the deposition chamber. A styrene/nitrogen concentration gradient is produced in the chamber such that the nitrogen content through the film is held between 4 and 5 atomic %. These data were taken under the conditions described for Fig. 4.

undergo flow shear (hydrodynamic lubrication). On the other hand, if the film is very thin, rather more stringent requirements are imposed on the lubricant; ideally, it must form a tightly bound, densely packed, oriented molecular layer on both sliding surfaces in such a way that the new surfaces formed by the portions of the lubricant molecules that extend outward can slide past each other without destroying the integrity of the bound lubricant layers (boundary lubrication).

A consideration of factors such as the long-term chemical stability, low vapor pressure, and physical form required for VideoDisc lubrication ruled out certain materials widely used elsewhere. At an early stage in the search for lubricants for this system, silicone fluids having the general structure



were extensively investigated. They have good chemical stability, can be vacuum distilled, are available in a wide range of molecular weights (vapor pressure, viscosity), and can be made with a great variety of different pendant "R" groups. While the conventional poly(methylsiloxanes) [$\text{R} = \text{CH}_3$] are poor lubricants, and do not perform well on VideoDiscs, it was found that a product of General Electric's Silicones Division (SF-1147) bearing a normal decyl group [$\text{R} = n\text{-C}_{10}\text{H}_{21}$] gave excellent results. The lubricant coatings were applied to the discs by spinning from dilute solutions in isopropanol or heptane. Investigations showed that performance does not depend significantly on the viscosity of the lubricant (varied by the choice of n , i.e., the molecular weight), but does depend on the thickness of the coating. Below about 150 Å, stylus wear becomes significant; above about 300–400 Å, the tendency for entrapment of particulate matter under the stylus becomes great. The optimum lubricant thickness for VideoDiscs is 200–250 Å. Calculations indicate that this thickness places the disc system in the boundary lubrication regime. Experiments showed that the coefficient of friction of the stylus sliding over the disc is not very sensitive to the sliding rate or the lubricant viscosity, lending further support to this view.

Most silicone fluids are poor boundary lubricants. The best boundary lubricants are typically relatively long linear hydrocarbon molecules with a polar group at one end that can bond in some way (chemically, physically, electrostatically) to the substrate to be protected. The extended pendant "tails" of these materials form a tightly packed (high compressive strength) layer whose thickness is related to the molecular chain length. The surfaces of these layers are comprised of the very ends of the hydrocarbon chains and have low surface energy. Thus, they possess poor attraction for one another and provide a shear plane when two such surfaces slide against each other.

Experiments using materials of this type were carried out. Fatty acids,

long-chain alcohols, and silicone fluids in which R is a long chain bearing a polar group at the end, showed superior results when applied to discs on which the dielectric layer had degraded. Stylus lift-off and disc cutting by entrapped particles were markedly reduced. Some of these materials also reduced the tendency for dust to adhere to the disc surface following humidification. However, these lubricants were found to have two shortcomings for use on VideoDiscs. Because they do not have available a mechanism for chemically bonding to the dielectric surface, they are held in place only by van der Waals and electrostatic forces. As a consequence of this and because it is the polar groups at the molecular termini that hold these lubricants in place, exposure to high humidity results in the preferential adsorption of water at the dielectric surface and solvation of the polar ends of the lubricant. The boundary layer is disrupted and disc performance tends to deteriorate. The other undesirable effect observed with true boundary lubricants was an increase in stylus wear rate.

Two elegant experiments showed, however, that even with materials not possessing polar end groups, there is an unexpected strong orientation or surface ordering effect of thin layers of certain lubricants, including SF-1147, on coated discs. Measurements of the spreading rate of a lubricant in the grooves of a coated disc, the driving force for which is capillary action, permits the calculation of the effective viscosity of the thin advancing film. Some materials studied showed an effective viscosity significantly higher than that of the bulk material. An analysis of the diffraction pattern produced when the grooved area of a disc is illuminated with a laser, together with comparison of the patterns before and after coating, permits the calculation of the optical thickness and contour of an applied (transparent) coating. Such measurements showed that layers of SF-1147 up to about 150 Å in thickness behave as though they are semisolid: the layers are very uniform in thickness and have no tendency to flow to the concave groove bottoms. If these thin lubricant layers were truly fluid, they would, under the influence of capillary forces, rapidly redistribute. Thus, it may be concluded that, even with SF-1147, some aspects of the boundary lubrication mechanism pertain.

The surface tension of SF-1147 is 26 dynes/cm, and this provides a guideline for specifying one of the most important properties of the dielectric layer. The surface energy of the dielectric must not fall much below this value or the lubricant will not wet and spread on its surface. On the other hand, if the surface energy is too high, high ambient humidity will lead to the preferential adsorption of water at its surface, displacing the SF-1147. As was discussed above, the initial surface energy of the dielectric and its resistance to change under the influence of intrinsic and externally caused chemical reactions are controllable by the specifics of the deposition process.

The potential benefits to be derived from the use of a "solid" lubricant made a search for such a system of continuous interest during development of the coatings. It was discovered that exposure of discs lubricated with SF-1147 and certain other fluids to a glow discharge resulted in crosslinking of the lubricant, rendering it insoluble in organic solvents and incapable of being removed by a Scotch tape test. The properties of this layer were critically dependent on the radiation dose: too little gave discs that wear rapidly, producing considerable debris; too much gave a surface that rapidly wears styli. A "proper" dose produced discs that performed extremely well. These layers had a low surface energy, and the adhesion of humidified dust was reduced. Unfortunately, the range of acceptable radiation dosage proved to be quite narrow and required a tight control of lubricant thickness and composition of the underlying dielectric layer. It was not possible to establish this approach as being useful for large-scale production. Little is known about the long-term stability of this class of coatings.

From the standpoint of the production vacuum coating process, the choice of SF-1147 was fortunate. This material can be deposited by a process resembling molecular distillation at a pressure of 5–10 millitorr. The "distillate" (material that condenses on the discs) has a molecular weight corresponding to $n = 3-4$ and a viscosity of 17–20 centistokes. About 15 percent of the 50-centistoke feedstock evaporates at a temperature of 240°C. No molecular decomposition or rearrangement is brought about as a result of distillation. Evaporated coatings of SF-1147 in general perform better in disc use tests than do spun-on coatings, and proved to be entirely satisfactory when applied to coated VideoDiscs.

Diamond Stylus Permits Simplified Coatings System

The production coatings produced by the processes described above reliably passed tests for corrosion resistance, adhesion, resistance to high temperature/humidity, the effects of humidified dust, disc wear, and chemical stability. Two properties of the system remained that were of concern. The stylus wear rate averaged about 0.3 cubic μm per hour, which meant that the stylus tip had to be shaped by a special lapping procedure to provide enough volume to last the desired 200 hours. The other system problem was the random occurrence of occasional cutting of the coatings during play tests, especially those performed following a humidified dust stress. This problem was shown to be related to the phenomenon described earlier wherein a particle becomes trapped between the stylus shoe and the disc surface and, as a result of the extremely high localized forces, acts as a tool to score the coatings. In these cases, the coatings were removed along with disc substrate material at

the bottoms of the grooves, attesting to the excellent coatings adhesion that had been achieved.

In an attempt to reduce the stylus wear rate, diamond was investigated as a stylus material. It was believed that the superior hardness of diamond would result in lower wear rates and, indeed, on the most abrasive coatings, substantial improvements in stylus life were realized with no adverse effects on the disc coatings. A finding of some interest was made when diamond styli were used on relatively unabrasive coatings such as the bilayer/styrene/SF-1147 system: the volumetric wear rates of sapphire and diamond are about equivalent. The interpretation of this observation in terms of the mechanism for stylus wear remains elusive.

A more significant discovery, however, was that the random disc cutting produced by sapphire styli was virtually eliminated with the use of diamond styli. The explanation for this was found by studying the performance of diamond and sapphire styli directly on discs coated only with metal. Sapphire had a marked tendency to damage Inconel coatings severely while diamond did not. The oxidized metal surface can bond strongly to the sapphire (aluminum oxide) shoe, but this mechanism is not available for diamond. This explanation was compatible with an earlier observation that trilayer/styrene/SF-1147 discs (metallic copper at the surface of the metal layer) showed somewhat less cutting than did bilayer discs. The mechanism for the disc cutting is thus seen to involve a momentary penetration of the lubricant and dielectric layers (brought about, for example, by an asperity or a sudden vertical acceleration of the surface) by the stylus, whereupon the shoe makes contact with and adheres to the Inconel layer. The adhered metal is pulled off and proceeds to cut the disc until it is worn away.

These observations led to the discovery of what has emerged as the coatings/stylus combination of choice. With diamond styli, bilayer discs do not need a separate dielectric layer if a good lubricant is used. This obviously simplifies the coatings considerably. A skewed oxygen profile is no longer needed in the Inconel, and the oxygen content can now be adjusted freely for corrosion resistance and stress relief. The elimination of the dielectric layer does away with the locus of most of the deposition complexities and the seat of many of the potential chemical instabilities. Considerably less debris is formed when the stylus/disc interface fails.

The requirements of the lubricant are still as outlined above. Perhaps because it was originally developed by the manufacturer to lubricate an aluminum (oxide coated) surface, SF-1147 remains the lubricant of choice for the bilayer/diamond interface.

This system produces essentially no disc cutting, meets the criteria

discussed above for corrosion resistance and chemical stability, passes all system testing, and is characterized by a stylus wear rate about one-third of that obtained with the bilayer/styrene/SF-1147/sapphire system.

The Ultimate Simplification: A Conductive Disc

In some of the early runs made in the production coater, Inconel coatings were produced that increased in resistivity on storage. The concern with this problem and the broader need to develop a meaningful specification for metal layer resistivity and thickness prompted a series of measurements to be carried out to determine the influence of conductivity on signal recovery with the 914-MHz capacitive pickup.

These measurements showed that, up to a resistivity of at least eight thousand ohms per square (measured at 914 MHz), the amplitude of the FM video output was unaffected. Calculations indicated that the system might function well with a resistivity exceeding $100 \text{ k}\Omega/\square$, and that a satisfactory conductivity might be achieved with the use of a disc molding resin filled with a conductive material.

The development of the carbon-loaded conductive disc is treated in this issue of *RCA Review* in the paper by L. P. Fox. A lubricant for this new surface is the one remaining coating under active investigation. Stylus wear tests have indicated that a lubricant lowers the wear rate by a factor of about 20 and, thus, is desirable. Interestingly, diamond styli produce less disc wear than is produced by sapphire styli.

The surface energy of the conductive discs is quite low and is on the border of being unsatisfactory for SF-1147. There is evidence that the surface properties of these discs are strongly influenced by the processing aids and additives added to the molding compound, some of which migrate to or are concentrated at the surface.

Having a disc that does not require vacuum-deposited coatings opens for serious consideration alternative techniques for applying the lubricant. Spin and spray procedures were investigated. It was found that most of the solvent vehicles useful for spinning have an undesirable effect on the disc surface, probably related to the dissolution of some of the compound additives present. This observation offers some guidance to the selection of a lubricant: it should not be capable of dissolving or swelling the disc surface, otherwise a deterioration of mechanical properties would be expected.

Spray coating is presently believed to be the method of choice, and it has been shown to be capable of producing uniform lubricant coatings with good control of thickness. This nonvacuum technique permits selection from a much wider choice of lubricants, inasmuch as high thermal

stability and ability to be distilled are no longer requirements. The requirements that still have to be met include a good match with the disc surface energy, ability to contend with particulate matter from the disc surface and from atmospheric dust, stability to extremes of temperature and humidity, and long-term chemical stability. Several modified silicone fluids have been identified that promise to meet these requirements.

For the long-range outlook, it is tempting to consider the possibility that compounding certain additives intentionally with the base resin and carbon would render the disc surface sufficiently well-lubricated that no external coating will have to be applied. At present, conductive discs have been fabricated that, when unlubricated, play well with diamond styli, showing virtually no disc wear. The stylus wear rate is only about a factor of 3-5 above that obtained with the bilayer/styrene/SF-1147 system.

Acknowledgments

During the portion of this program when the laboratory work was being translated into production procedures and thousands of discs were being coated and tested, well over 50 scientists and engineers were actively involved. With this large an effort, it is likely that some names will inadvertently be omitted from the list that follows. For these errors of omission, the author apologizes. However, he expresses his sincerest thanks to all who participated in this challenging work, among whom were A. S. Arena, A. E. Bell, J. B. Berkshire, J. C. Bleazey, A. Bloom, E. M. Botnick, P. J. Call, J. Chang, M. D. Coutts, H. N. Crooks, P. Datta, L. A. DiMarco, N. V. Desai, F. L. Dixon, O. E. Dow, L. Ekstrom, D. G. Fisher, G. O. Fowler, L. P. Fox, J. S. Fuhrer, W. J. Gordon, A. D. Grubb, B. Halon, J. J. Hanak, L. J. Hampton, W. L. Harrington, D. I. Harris, B. Hershenov, R. J. Himics, E. F. Hockings, D. M. Hoffman, F. R. Holt, R. E. Honig, R. H. Huck, E. A. James, M. M. Jeskey, G. Kaganowicz, M. Kaplan, H. Kawamoto, J. Kiss, A. Knottenbelt, D. A. Kramer, J. S. Levin, E. S. Lo, G. S. Lozier, C. W. Magee, J. R. Mason, D. L. Matthies, J. F. McLaughlin, R. M. Mehalso, M. E. Miller, M. J. Mindel, R. M. Moore, G. F. Nichols, R. W. Nosker, F. R. Nyman, J. J. O'Neill, R. J. Paff, R. C. Palmer, E. B. Priestley, P. Rappaport, F. R. Reed, J. H. Reisner, W. R. Roach, J. W. Robinson, S. D. Rose, R. J. Ryan, H. G. Scheible, G. L. Schnable, P. Sheng, T. E. Smith, H. R. Snow, J. H. Thorn, B. E. Tompkins, E. G. Trachman, J. L. Vossen, C. C. Wang, H. Wielicki, R. Williams, and P. Zanzucchi.

References:

- M. Kaplan and D. L. Matthies, "Metallized VideoDisc Having an Insulating Layer Thereon," U.S. Patent 3,843,399 (Oct. 22, 1974).
- D. L. Matthies, "VideoDiscs Having a Methyl Alkyl Silicone Coating," U.S. Patent 3,833,408 (Sept. 3, 1974).
- R. M. Mehalso and G. Kaganowicz, "Metallized VideoDisc Having a Dielectric Coating Thereon," U.S. Patent 3,901,994 (Aug. 26, 1975).
- R. M. Mehalso, "Method of Making a Metallized VideoDisc Having an Insulating Layer Thereon," U.S. Patent 4,018,945 (April 19, 1977).
- F. R. Nyman, J. L. Vossen, D. G. Fisher, and G. F. Nichols, "Metal Coating for VideoDiscs," U.S. Patent 3,982,066 (Sept. 21, 1976).
- J. L. Vossen, F. R. Nyman, and G. F. Nichols, "Adherence of Metal Films to Polymeric Materials," U.S. Patent 3,984,907 (Oct. 12, 1976).
- J. L. Vossen, F. R. Nyman, D. G. Fisher, and G. F. Nichols, "Metal Coating for VideoDiscs," U.S. Patent 4,004,080 (Jan. 18, 1977).
- R. Williams, "The Advancing Front of a Spreading Liquid," *Nature*, **266**, p. 153 (1977).
- G. Kaganowicz and J. W. Robinson, "VideoDisc with a Dielectric Layer Formed from Styrene and Nitrogen," U.S. Patent 4,072,985 (Feb. 7, 1978).
- J. L. Vossen, Jr., "VideoDisc with a Conductive Layer Having an Oxygen Content Gradient," U.S. Patent 4,077,051.
- J. L. Vossen, Jr., "VideoDisc Capacitive Recording Means with a Conductive Bilayer," U.S. Patent 4,077,052.

Optical Techniques Developed for the RCA VideoDisc

I. Gorog

RCA Laboratories, Princeton, N.J. 08540

Abstract—Very-high-resolution laser readers that allow optical playback of RCA VideoDiscs were developed. A wide variety of novel optical instruments were constructed to provide rapidly obtainable data on disc performance for manufacturing process control. This paper presents an overview of the optical research and development efforts conducted as part of the VideoDisc effort, with the exception of optical recording, which is described in another paper in this issue of *RCA Review*.

1. Introduction

Optical techniques are extensively used for VideoDisc manufacturing process control and quality assurance. Our research has led to the development of instrumentation for optical reading of disc masters, as well as flaw detection and precision measurement of signal depth and groove geometry on masters, intermediate metal parts, and replicas. The dimensions of the smallest signal elements on the four-TV-frames-per-revolution RCA VideoDiscs are substantially smaller than the wavelength of light. Also, the signal elements of adjacent tracks touch each other, and thus no intertrack optical reference surface exists. Consequently, conventional, single-axial-detector, optical systems have insufficient resolution to read out the RCA VideoDisc format. We have developed a novel off-axis, differential-phase optical detector arrangement that successfully overcomes the resolution limitations of conventional systems. We can now reliably obtain excellent quality optical readout with 0.63 μm wavelength HeNe laser sources from VideoDiscs

with signal element dimensions as small as $0.25 \mu\text{m}$. Optical readers are now routinely used in the RCA VideoDisc pilot production facility for master-disc signal performance evaluation.

In addition to optical reading systems, we have also developed instruments that allow quick detection of microscopic disc defects and provide means for practical, quick, and accurate determination of the groove geometry and signal depths. These instruments are the primary disc-manufacture quality-control tools used to assure that defect-free masters and faithful replicas are produced.

In the course of our optical investigations, we explored optical readout by semiconductor lasers, optical recording techniques, and pertinent fundamental theoretical calculations. Some of our experimental data suggested a breakdown of the scalar theory of optical resolution. Therefore, we solved exact boundary-value problems for both focused and collimated laser beams incident on signal elements that are smaller than the wavelength of light. The most significant result of these calculations concerns the VideoDisc signal-element depth versus readout-signal amplitude relation. We found that, in contradiction to scalar theory predictions, it is possible to construct optical systems for which the signal amplitude stays approximately constant and equal to its optimum value for all signal depths such that $\pi/2 \lesssim \phi_r \lesssim \pi$, where ϕ_r is the optical phase retardation difference caused by the difference between the disc surface elevation at signal maxima and that at signal minima.

This paper presents an overview of the optical reading and measurement techniques we have developed as part of the RCA VideoDisc program. Our optical *recording* results are presented in this issue of RCA Review in E. O. Keizer's paper describing the RCA VideoDisc mastering methods.

2. Signal Reading Considerations

Optical reading of RCA VideoDiscs was considered to be a formidable task. The principal difficulty was that conventional optical systems have insufficient resolution. The four-TV-frames-per-disc-revolution signal format results in signal wavelengths that are approximately equal to the wavelength of visible light. Also, the signal geometry employed is not well suited for reading with conventional optical scanning arrangements. The signal elements are approximately $0.07\text{-}\mu\text{m}$ -deep slots placed on the bottom of the grooves. The center-to-center groove spacing is approximately $2.5 \mu\text{m}$. Adjacent grooves are in close proximity to each other. The signal slots extend across the entire transverse dimension of the grooves and the signal slots from adjacent grooves may touch each other. On the innermost tracks, the wavelength of the highest recorded signal fre-

quency is approximately $0.5 \mu\text{m}$. Thus the slot dimension along the groove for the highest signal frequency of interest is approximately $0.25 \mu\text{m}$.

To optically determine the presence or absence and precise width of such signal slots with a conventional optical system, we would need an optical beam that is less than $0.25 \mu\text{m}$ wide along the groove. As a result of diffraction limitations, the minimum theoretically achievable optical beam width is

$$w = \frac{\lambda}{2\text{NA}}, \quad [1]$$

where λ is the wavelength of the light used and NA is the numerical aperture of the focusing objective. In principle, the numerical aperture may approach unity, independently of wavelength. High-NA lenses, however, are designed for use with visible light, and the best available lenses were found to exhibit a focusing ability that does not exceed the diffraction-limited performance of an ideal lens with $\text{NA} \approx 0.8$. If an optical reader were to utilize the convenient red HeNe laser line, the achievable minimum beam width should be approximately $0.4 \mu\text{m}$; if it used the blue HeCd line, this beam width would be $0.3 \mu\text{m}$. Thus we can conclude, on fundamental theoretical grounds, that it is impossible to build a conventional optical reader for RCA VideoDiscs using lasers that operate in the visible spectrum. By employing an ultraviolet laser, we could expect marginal performance at best.

2.1 Split-Detector System

The resolution limitation of conventional optical systems was overcome through the development of a novel "split-detector" electro-optical arrangement that, when used with the RCA VideoDisc format, provides twice the resolution of conventional systems.

Fig. 1a outlines the conventional arrangement. Here a collimated laser beam is incident on a beam splitter and the portion of the incident light that is reflected by the beam splitter is focused by the objective lens onto the disc. The light is reflected by the disc and is collected by the focusing lens. The component of the return light that is transmitted by the beam splitter is incident onto a centrally positioned photodetector. The intensity variations of the light incident on the detector will result in a detector output signal that correlates with variations of the disc-surface topology. A peak signal is detected when the beam is focused onto a flat portion of the disc. When the beam is incident on a region that exhibits a surface gradient, e.g., on a slot edge, part of the light reflected by the disc will be diffracted out of the focusing lens aperture and will thus not

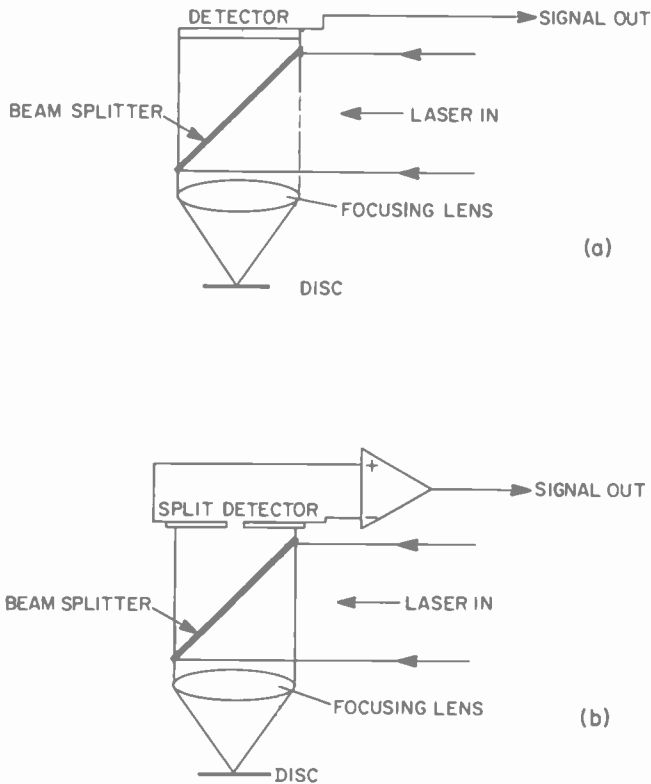

Fig. 1—VideoDisc optical readers: (a) conventional arrangement using an axial detector and (b) differential-phase split-detector arrangement.

be collected. Therefore, in these surface gradient regions the photodetector output will be less than in the smooth regions.

Fig. 1b illustrates the split-detector arrangement that we developed. Here the basic optical arrangement is the same as that described above for the conventional system, except that now the detector is split into two halves and the signal output consists of the difference of the outputs of the two halves of the split detector. This arrangement makes explicit use of the fact that when the focused beam illuminates a phase grating, the output signal produced by the interference of the zeroth and plus-first diffraction orders is exactly 180° out of phase with respect to that produced by the interference between the zeroth and the minus-first diffraction orders.

Let us assume that the disc surface consists of a surface relief pattern that can be considered to be a reflective one-dimensional sinusoidal phase grating. This grating is illuminated by a focused laser beam. For

the purpose of the following discussion, and with reference to Fig. 2, let us assume that the lens is fully illuminated by a uniform-intensity collimated beam. We also assume that the grating is shallow, i.e., that $d \ll \lambda$, where d is the peak-to-peak grating depth. Then the amplitude reflection coefficient of the grating can be written as

$$R(x) = e^{i\delta \sin\beta(x-vt)} \approx 1 + i\delta \sin\beta(x-vt), \quad [2]$$

where the x, y, z coordinate system is defined in Fig. 2, v is the disc velocity, t is the time variable, $\delta = 2\pi d/\lambda$, $\beta = 2\pi/\Lambda$, and Λ is the spatial wavelength of the assumed sinusoidal signal on the record.

The disc surface is located at $y = 0$ in the focal plane of the lens, where a diffraction-limited illuminating spot is formed. The optical wavefront at the focal plane of a perfect diffraction limited lens is a plane wave. Then in the vicinity of the $y = 0$ plane, where $|y| \ll w^2/\lambda$, the amplitude of the incident optical wave, A_i , is well described by

$$A_i = B_o A(x, z) e^{-i(ky + \omega t)}, \quad [3]$$

where $k = 2\pi/\lambda$, $\omega = ck$, c is the speed of light, B_o is proportional to the square root of the focused beam power, and $A(x, z)$ is a real function of

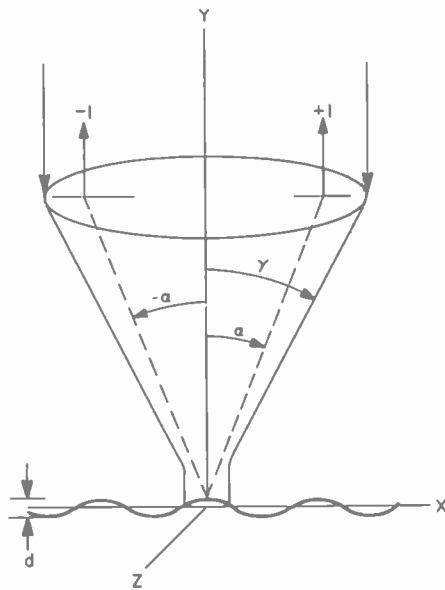

Fig. 2—Schematic outline illustrating the key aspects of optical scanning of a reflective phase grating with a diffraction limited lens.

the focal plane coordinates and describes the amplitude distribution of the focused spot in the focal plane. As a result of our assumption that the grating is shallow, ky is much smaller than 2π in the vicinity of the grating. Then, from Eqs. [2] and [3], the reflected-wave amplitude immediately above the grating can be written as

$$A_r = B_0 A(x, z) e^{-i\omega t} \left[1 + \frac{\delta}{2} e^{i\beta(x-vt)} - \frac{\delta}{2} e^{-i\beta(x-vt)} \right]. \quad [4]$$

In a manner identical to the treatment of the diffraction caused by a phase grating illuminated by an infinite plane wave, in the region $d/2 < y \ll w^2/\lambda$ the reflected wave is described by

$$A_r(x, y, t) = B_0 e^{-i\omega t} \left[A_0 e^{iky} + \frac{\delta}{2} A_1 e^{ik[y\cos\alpha + (x-vt)\sin\alpha]} - \frac{\delta}{2} A_{-1} e^{ik[y\cos\alpha - (x-vt)\sin\alpha]} \right] \quad [5]$$

where

$$\sin\alpha = \frac{\beta}{k} = \frac{\lambda}{\Lambda}. \quad [6]$$

The three terms in the bracket of Eq. [5] describe three waves propagating, respectively, parallel and at angles $\pm\alpha$ with respect to the y axis in the x, y plane. The amplitude distribution $A_0 = A(x, z)$. A_1 and A_{-1} are similar to A_0 but they are renamed for explanatory purposes. They can be thought of as waves emanating from an aperture that has an amplitude distribution given by A_0 and that is illuminated at angles $\pm\alpha$, respectively.

The three reflected waves propagate back towards the lens. Diffraction causes the plane wave-fronts of Eq. [5] to curve and expand. The first term in the bracket, which is proportional to A_0 , exactly retraces the illuminating wave, and it exits from the lens as a uniform intensity collimated beam that fully fills the lens. The waves A_1 and A_{-1} are reflected in the $\pm\alpha$ directions and they also exit from the lens as uniform intensity collimated beams that propagate parallel to the y axis; however, the extent to which they fill the lens depends on the value of α . In the sense of geometric optics, the three waves originate from three different sources that are all at the same axial point in the focal plane of the lens. Therefore, upon exiting from the lens, these waves are all plane waves propagating parallel to the y axis. In any $y = \text{constant}$ plane they have a constant phase and their relative phases are the same as those at $y = 0$, described by Eq. [4].

In a VideoDisc reader, we are interested in determining, from the intensity of the light collected by the lens, the position of the grating

pattern as a function of time. The signal produced by a photodetector is proportional to the absolute square of the amplitude of the light wave incident on the detector. The total light intensity detected by the photodetector is composed of six interference terms produced by the three waves. The extent of overlap of the three incident waves emerging from the lens depends on the value of α . With reference to Eq. [4], we denote the interference terms by $I_{m,n}$, where m and n refer to the waves that produce the given interference term. From Eq. [4] we find that $I_{0,0}$, $I_{1,1}$, and $I_{-1,-1}$ are time-independent dc terms. Grating position information is contained in the three cross terms

$$I_{0,1} = B_o^2 \delta \cos \beta(x - vt) \quad [7]$$

$$I_{0,-1} = -B_o^2 \delta \cos \beta(x - vt) \quad [8]$$

$$I_{1,-1} = B_o^2 \frac{\delta^2}{2} \cos 2\beta(x - vt). \quad [9]$$

All three of the above interference terms contain information about the grating position. For these terms to be present, however, the waves producing them must overlap at the detector. With reference to Fig. 2, note that if α is sufficiently small, such that $\alpha < \gamma$, where $\gamma = \arcsin \text{NA}$, the term $I_{1,-1}$ is present. The overlap region producing $I_{1,-1}$ is centered on the y axis, and a single centrally positioned photodetector will produce an output signal proportional to $I_{1,-1}$. As indicated by Eq. [9], this detector cannot distinguish between the grating positions such that $\beta(x - vt) = 0$ and $\beta(x - vt) = \pi$, and the detector output signal frequency is twice that of the recorded signal. The $I_{0,1}$ and $I_{0,-1}$ terms are equal in magnitude but opposite in sign and, therefore, the contributions to the single-axial-detector output from these two terms exactly cancel each other. Thus we conclude that the single-axial-detector arrangement, commonly employed in conventional optical scanning systems, cannot produce a useful output from a signal recorded in the RCA VideoDisc format.

The terms $I_{0,1}$ and $I_{0,-1}$ can be utilized, however, if we split the detector into two halves, one half extending over the region $x > 0$ and the other over the region $x < 0$. With such a split-detector arrangement, the signal cancellation can be avoided by electronically inverting the output of one of the detectors and adding this inverted signal to the output of the other detector. By comparing Eqs. [7] or [8] with [2], we find that the split-detector output is 90° out of phase with respect to the recorded signal. This phase shift, however, is of no consequence with the FM signal-coding system employed. Thus the split detector arrangement can successfully overcome the constraints presented by the one-dimensional grating signal format.

A further significant advantage of the split-detector system is that it provides a factor of two improvement in resolution over the conventional single-axial-detector arrangement for the one-dimensional grating signal format. The axially symmetric $I_{1,-1}$ term is only present for $\alpha < \gamma$ or for $\text{NA} = \sin \gamma > \sin \alpha = \lambda/\Lambda$, i.e., this arrangement can only resolve signals with $\Lambda > \lambda/\text{NA}$. The $I_{0,1}$ and $I_{0,-1}$ terms will be present as long as at least some of the +1 and -1 wave components are collected by the lens. As Fig. 2 indicates, these components will be collected for $\alpha < 2\gamma$. Thus the cutoff-signal wavelength with this arrangement is $\Lambda > \lambda/2\text{NA}$. The cutoff-signal wavelengths with some of the most convenient laser wavelengths and with $\text{NA} = 0.8$ are as follows: with a $0.4416 \mu\text{m}$ HeCd laser, $\Lambda = 0.276 \mu\text{m}$; with a $0.6328 \mu\text{m}$ HeNe laser, $\Lambda = 0.396 \mu\text{m}$; and with a $0.78 \mu\text{m}$ AlGaAs injection laser, $\Lambda = 0.488 \mu\text{m}$. Since the shortest recorded signal wavelength on the one-hour-per-side RCA VideoDisc is approximately $0.5 \mu\text{m}$, all three of these laser sources can provide the resolution required for reading such discs when the differential-phase split-detector arrangement is employed.

2.2 Signal Depth Considerations

The approximate signal depth on RCA VideoDiscs is $0.07 \mu\text{m}$. It is well known that with conventional optical-scanner arrangements that utilize an axial detector, maximum phase-grating signal contrast is obtained when the phase-retardation difference between the rays traveling through grating peaks and those traveling through valleys is π radians. For reflective gratings, this retardation difference corresponds to a grating depth of $\lambda/4$. The optimum reflection grating depth for split-detector readout is $\lambda/8$, or $0.079 \mu\text{m}$ for systems that employ the red HeNe laser. Thus, such systems will provide close to optimum performance with the RCA VideoDisc signal depth.

The difference between the optimum phase conditions for the axial and split-detector arrangements can be explained as follows. With reference to Fig. 3, consider two rays, p and q, of an optical beam that illuminates, at perpendicular incidence, a phase object. For the purposes of our illustration let us assume that the phase object has a planar surface such that, as indicated in Fig. 3, over part of the surface the reflected rays suffer a phase retardation ϕ_r with respect to other parts of the same surface. Let us assume that an axial detector is employed. Maximum axial light is detected when the phase difference between the axially reflected rays p and q is zero, and minimum axial reflection occurs when the phase difference is π ; thus maximum axial signal contrast is obtained for $\phi_r = \pi$. Now let us consider rays p' and q' that are scattered at angle θ . The phase difference between these two rays is $\phi(p') - \phi(q') = \phi_r -$

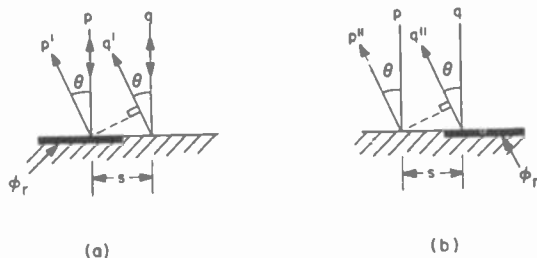

Fig. 3—Reflection at a phase step. The phase steps shown in (a) and (b) have opposite polarity.

$(2\pi s/\lambda) \sin\theta$. When $\phi_r = 0$, the surface appears as a smooth mirror, only axial reflection occurs, and the outputs of the two off-axis detectors are equal. When $\phi_r = \pm\pi$, the contribution from rays p' and q' to the amplitude of the plane wave scattered at angle θ is $1 - e^{-i\rho}$, where $\rho = (2\pi s/\lambda) \sin\theta$. The corresponding contribution to the plane wave scattered at angle $-\theta$ is $1 - e^{+i\rho}$. Thus the intensity of the reflected light is symmetrical about $\theta = 0$ and the outputs of the two detectors in Fig. 1b are equal and the differential signal output is zero. In general, the contribution from rays p' and q' to the amplitude of a plane wave scattered at angle θ is $1 + e^{i(\phi_r - \rho)}$ and the corresponding intensity is $I'(\theta) = 2 + 2 \cos(\phi_r - \rho)$. Similarly, at angle $-\theta$ it is $I'(-\theta) = 2 + 2 \cos(\phi_r + \rho)$. Thus the contribution to the differential output of a split detector is $D' = I'(\theta) - I'(-\theta) = -4\sin\phi_r \sin\rho$. When a finite length phase step is moved across an illuminating beam it may first appear as shown in Fig. 3a and subsequently as shown in Fig. 3b. The ray phase difference in Fig. 3b is $\phi(p'') - \phi(q'') = -\phi_r - \rho$ and the contribution of rays p'' and q'' to the split-detector output is $D'' = +4\sin\phi_r \sin\rho$. As the phase step moves across the beam, maximum peak-to-peak split-detector output signal is obtained when $|D' - D''|$ is maximum, i.e., when $\phi_r = \pm\pi/2$. For a reflective surface relief phase grating this ϕ_r , which maximizes the differential signal, corresponds to $d = \lambda/8$.

2.3 Formal Analysis

The above outline of the performance of the differential-phase split detector as an optical reader for RCA VideoDiscs was based primarily on qualitative arguments. A complete analysis based on the formalism of Fourier optics has been performed¹ and some of the results are shown in Figs. 4, 5, and 6. On these figures $a = \text{NA}$. Fig. 4 shows the output waveshape of the conventional axial detector for several diffraction-limited spot sizes as a function of the position of the reading spot over

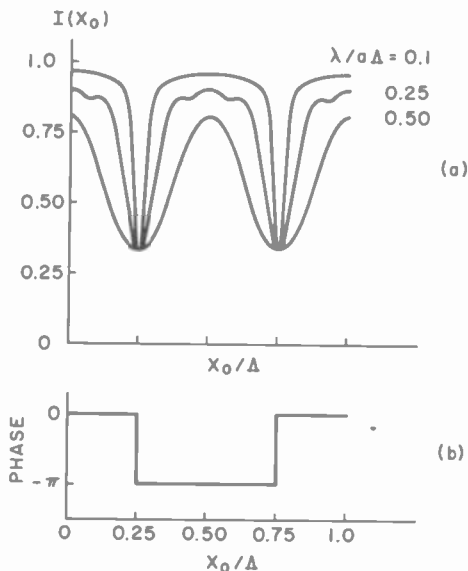

Fig. 4—Signal reading with an axial detector: (a) normalized axial-detector signal output as a function of scanning-spot displacement for several values of signal frequency and (b) square-wave phase grating profile.

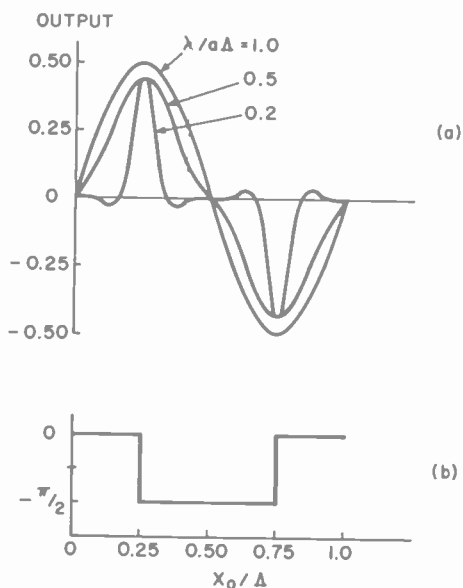

Fig. 5—Signal reading with a differential-phase split detector: (a) normalized split-detector signal output as a function of scanning-spot displacement for several values of signal frequency and (b) square-wave phase grating.

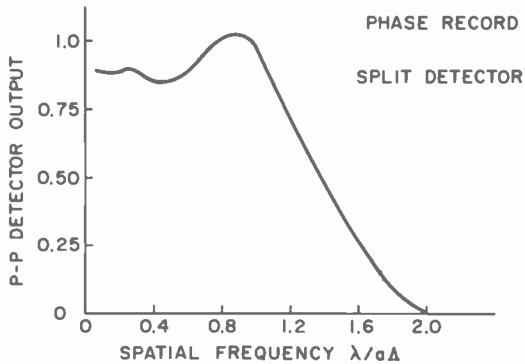

Fig. 6—Square-wave frequency response of a differential-phase split detector. Peak-to-peak detector output, normalized to unity at the frequency of maximum output, is plotted as a function of spatial frequency for an optimum-depth, $\pi/2$ -phase-shift, square-wave phase grating.

an optimum-depth, square-wave phase grating. Fig. 5 shows the corresponding results for a split-detector arrangement. In Fig. 6 the square-wave frequency response for a split detector is presented.

Both the qualitative arguments presented here and the Fourier optics calculations predict that the split-detector output as a function of signal depth should go through a maximum at $\phi_r = \pi/2$ and reach zero at $\phi_r = \pi$. Early experimental attempts to verify this phase dependence failed. Instead, it was found that the detector signal indeed increased as the depth was increased from zero to $\lambda/8$, but that it did not significantly decrease as the depth approached $\lambda/4$. Subsequently, exact wave-equation calculations were undertaken and the boundary value problem was solved for infinite-surface-conductivity, square-wave gratings, illuminated with focused optical beams. The results showed that the predictions based on the earlier scalar calculations are qualitatively correct for shallow ($d < \lambda/8$) gratings, but that as the grating depth is increased the scalar predictions for strongly focused beams are entirely erroneous.

These exact calculations also showed, in good agreement with the experimental results, that if either the signal wavelength or the focused spot size is approximately equal to the light wavelength, then polarization effects become very strong. The preferred polarization for reading the RCA VideoDisc signal format with a *split detector* is such that the optical electric field vector in the focused spot points in the radial disc direction. For this polarization, the optimum signal depth is reached at approximately $d = \lambda/4$, and as the depth is further increased the split-detector output stays essentially constant. The exact calculations also

show that, for reading RCA VideoDiscs with a high numerical aperture lens and an *axial detector*, the optimum polarization is such that the optical electrical field vector points in the tangential disc direction.

As far as the resolution limits are concerned, the approximate scalar and the exact vector calculations are in full agreement, indicating that optical reading of one-hour-per-side RCA VideoDiscs can only be accomplished with the differential-phase split-detector arrangement.

3. Optical Readers

A number of optical readers were constructed with the primary objective of monitoring the mastering process. Currently, optical readers are the primary tools for verifying the recorded signal quality on master discs. The measurements routinely performed on masters include measurement of signal discontinuities, frequency response, and signal-to-noise ratio. For electromechanical mastering systems, instant optical replay provides equalization information for dynamic trimming of cutter-head drivers.

The optical system schematic of a VideoDisc master reader is shown in Fig. 7. The system shown here employs stationary optics and a moving turntable. Radial translation is obtained by mounting the turntable on

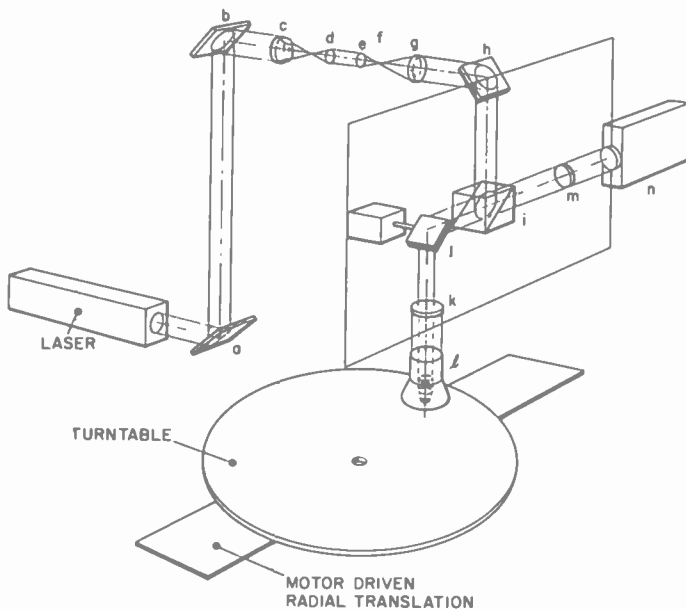

Fig. 7—Schematic outline of the optical system developed for reading VideoDiscs.

a precision slide driven by a lead screw. Precision timing is provided by the precisely controlled rotation rate of the turntable. The lead-screw motor drive signal is derived from the low-frequency component of the tracking-error signal. This method of radial advance control assures that the reading beam is always centered with submicron precision on the average radius of the current track, independently of possible track eccentricities and pitch errors. Focus servo is achieved with either an air-puck system or with a loudspeaker-like coil suspension that utilizes a capacitive focus-error sensor. Capacitive sensors are convenient since the disc masters either are directly cut into metallic substrates or they consist of metal-film-overcoated photoresists; the master surface always provides a reliable electric ground plane. Optical focus sensing was found to be not sufficiently reliable for a routine production environment, because the presence of grooves may lead to interaction between the focus and tracking servo systems.

The main focusing objective, component l in Fig. 7, is a high-quality microscope objective with a numerical aperture typically in the range of $0.8 < NA < 0.95$. The total allowable focus-error range with a red HeNe laser and with $NA = 0.8$ is approximately $0.5 \mu\text{m}$. With the surface errors typically encountered on master substrates, both the air puck and the electromechanical servo systems are able to maintain the focus error well within the allowable range. Groove tracking is accomplished by galvanometer j. The beam splitter, i, directs the incoming laser beam towards the disc and it allows the reflected beam to be transmitted to the photodetector system, n. The detector element is a 4-quadrant Si photodetector that is set in such a way that the difference between two of the cells provides the differential-phase split-detector signal; the other two cells provide the tracking information. The rest of the optical system comprises standard optical components that provide a collimated, suitably shaped laser beam incident on the beam splitter.

The spatial frequency response of a large number of commercially available high-quality, large NA microscope objectives was evaluated using an interferometrically calibrated, moving knife edge.² A typical result is presented in Fig. 8, where the modulation transfer function (MTF) at the red HeNe laser wavelength of $0.6328 \mu\text{m}$ for an $NA = 0.9$ objective is shown. In this figure, curve "a" is the measured result and the straight line, denoted as b, is the MTF of a uniformly illuminated, square-aperture, diffraction-limited lens with $NA = 0.7$. In general, extensive numerical computations are required to calculate, from the measured lens MTF, the frequency response applicable to VideoDisc readout. Very useful estimates of the frequency response of VideoDisc readers can be obtained, however, by approximating the actual lens response by an equivalent square-aperture response.

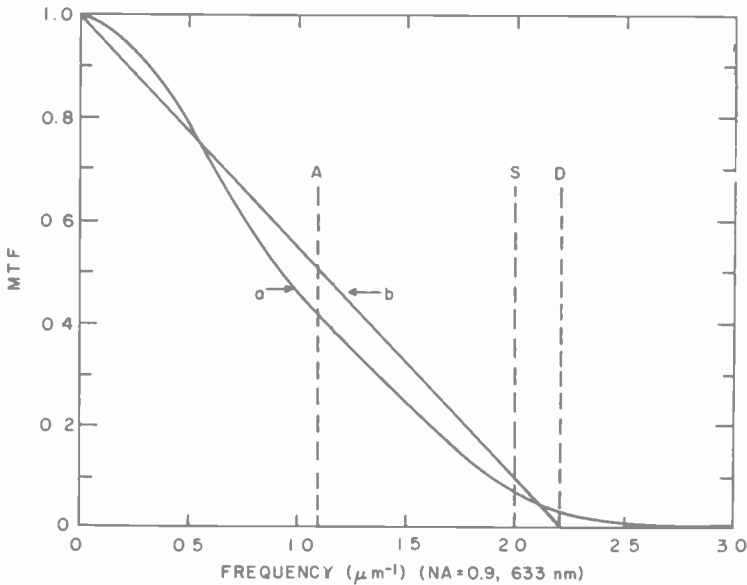

Fig. 8—Modulation transfer function of a commercially available, high quality microscope objective (NA = 0.9). *A* is the axial-detector cutoff frequency, *S* the spatial frequency corresponding to the shortest VideoDisc signal wavelength, and *D* is the split-detector cutoff frequency.

Let us estimate the actual response "a" by the approximate response "b" in Fig. 8. Then, as discussed in Sec. 2, the cutoff wavelength for an axial detector reading the one-dimensional grating signal format is $\Lambda = \lambda/\text{NA}$. The corresponding axial detector cutoff frequency, $A = \text{NA}/\lambda$, is shown in Fig. 8. Using an axial detector, only spatial frequencies lower than $1.1 \mu\text{m}^{-1}$ or wavelengths longer than $0.9 \mu\text{m}$ can be read with this lens. The shortest VideoDisc signal wavelength is approximately $0.5 \mu\text{m}$ and the corresponding spatial frequency is denoted by *S* in Fig. 8. The cutoff frequency with the differential-phase split-detector arrangement is denoted by *D*. The approximate split-detector frequency response for the lens under test can be obtained with the aid of the above frequency limits from the general square-wave response curve shown in Fig. 6. With reference to Figs. 6 and 8, the normalized spatial frequency at spatial frequency *S* is $1.8\lambda/a\Lambda$ and, thus, at the highest VideoDisc signal frequency of interest the split-detector output is down by a factor of ten, or -20 dB , from its maximum possible value. The split-detector response is significantly influenced by the detector geometry and by the actual shape of the lens MTF. Using suitably shaped detectors, at any selected signal wavelength in the range $\infty > \Lambda > \lambda/2\text{NA}$ the relative response can

be increased over its value shown in Fig. 6. Experimentally, less than 10 dB variation was achieved for all signal wavelengths in the range from 0.5 to approximately 1 μm .

Successful VideoDisc readout was accomplished³ with HeCd, HeNe, and AlGaAs lasers. The performance of master readers utilizing 0.4416 μm HeCd sources and of those employing 0.6328 μm HeNe sources was found to be approximately the same. At 5 MHz with a 30-kHz bandwidth, carrier-to-noise ratios in excess of 60 dB have been achieved on the innermost radius of the disc. With AlGaAs injection lasers, the wavelength limitations become noticeable. The smallest spot size achieved with an AlGaAs laser operating at approximately 0.82 μm was 0.64 μm full width at half intensity.⁴ Even though a high-quality picture could be obtained from a VideoDisc master with this source, the reader was found to be extremely sensitive to focus errors, and the lack of adequate frequency response was noticeable at sudden black-to-white transitions in pictures recorded on the innermost radius. These transitions correspond to the highest spatial frequencies for the RCA signal coding.⁵ With an RCA Laboratories experimental AlGaAs laser operating at 0.765 μm ,^{6,7} the focus sensitivity was much reduced, and a stable 52-dB carrier-to-noise ratio was measured on the inside radius.

A photograph of the first optical reader installed at the RCA VideoDisc pilot production facility is shown in Fig. 9. Using a HeNe source, this unit routinely produces carrier-to-noise ratios in the range of 55 to 60 dB. It was installed more than a year ago as a mastering process-control tool and has been providing a reliable service ever since.

4. Optical Measuring Instruments

In the production of VideoDiscs it is imperative to ascertain that the incoming electrical signal is correctly recorded on the master and that the master is faithfully reproduced without defects. The optical reader described in the previous section is primarily used to check the signal quality of the master. This section describes three additional optical instruments that are currently used to locate microdefects, to measure groove and signal depths during various stages of replication, and to measure directly the displacement and the frequency response of cutting styli used in the electromechanical master recorder.

4.1 Defect Detector

When the final replicated discs are played with a playback stylus guided by the grooves, the most troublesome obstacles that the stylus may encounter are defects that cover several grooves. Such large defects may



Fig. 9—Photograph of a VideoDisc optical reading system developed for routine production control.

lead to separation of the stylus from the disc surface, to loss of carrier, and to stylus breakage. Very small defects that are localized within a groove are not likely to interfere significantly with the stylus-guiding action of the grooves. All defects present on the master recording or on the stamper are reproduced on the replicas. It became clear sometime ago that it would be very desirable to develop an instrument that would be capable of locating, counting, and mapping the location of defects in the approximate size range of 5 to 500 μm . The defect detector described below is now accomplishing this task successfully.

The operation of the defect detector can be easily understood with the aid of Fig. 10. A laser beam is incident on the disc surface at approximately 45° with respect to normal, in a radial plane of incidence. Assume that the beam is weakly focused, so that in the focal region the spot size is much larger than a groove width and several tracks are illuminated simultaneously. (For the clarity of the illustration, this aspect is not shown correctly in Fig. 10.) Both the grooves and the signal ele-

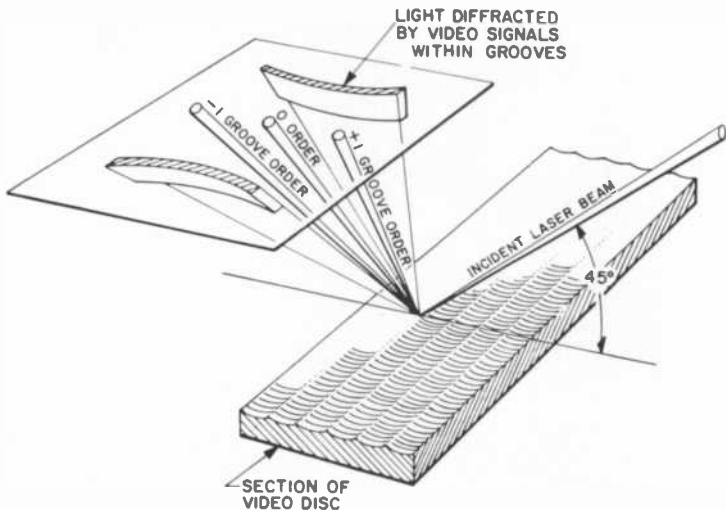

Fig. 10—Schematic outline of the diffraction spectrum produced by illuminating a VideoDisc with a weakly focused laser beam.

ments diffract the beam, and the reflected beam is broken up into several distinct components. The groove diffraction leads to discrete orders, of which the lowest three are shown. The groove diffraction orders are displaced with respect to each other in the radial direction. The 0th order coincides with the direction of specular reflection. For visible laser light the ± 1 st orders are separated from the 0th order by approximately 15° . The signal slots produce two continuous diffraction spectra that are displaced symmetrically with respect to the groove spectrum in the tangential disc direction. The separation of the groove orders from the signal continua depends on the disc radius. At the outside, the closest signal diffraction is caused by the sound carrier and is displaced by $\sim \pm 2^\circ$ from the groove orders; on the inside radius this spacing is $\sim \pm 4^\circ$. At all radii, however, most of the energy in the signal continuum is at angles larger than 10° . The spectrum shown in Fig. 10 corresponds to a defect-free disc surface. A defect generates a continuous spectrum that is superimposed on the perfect disc diffraction pattern. If the defect is smooth and it covers N grooves, then the defect diffraction pattern will be localized around the 0-order beam within a radius equal to $1/N$ times the 0th to 1st order distance. Large, rough defects will distribute their spectrum more uniformly. By arranging an optical detector system in such a way that only light scattered in the inter-order directions is collected, the presence or absence of defects can be detected.

The optical schematic of a defect detector built according to the above

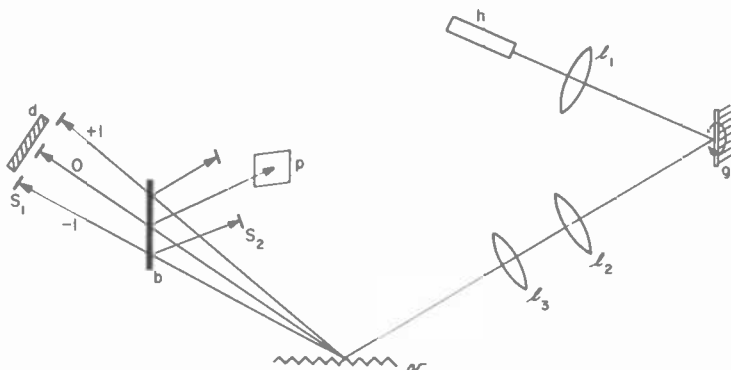

Fig. 11—Schematic outline of the optical system of a VideoDisc defect detector.

principles is shown in Fig. 11. Here light from laser h is focused by lens l_1 onto galvanometer g , and the spot thus formed is imaged onto the disc surface v by lenses l_2 and l_3 . The light diffracted by defects on v is collected by photodetector d . The set of stops s_1 is arranged so that all the defect-free diffraction is blocked from reaching the detector. Beam splitter b diverts a fraction of the reflected light. Stops s_2 are arranged so that only the 0th order reflection component reaches the beam position detector p . The output of p indicates if a tilt in the disc surface occurs, and it is used to adjust galvanometer g in such a way that the primary diffraction orders are always blocked by stops s_1 . This servo feature is required to assure that, within the allowed range, the defect detector sensitivity is independent of disc warpage. Typical defects that were automatically detected on an experimental disc are shown in Fig. 12.

A recent version of the defect detector is shown in Fig. 13. This instrument was built to meet the safest Bureau of Radiological Health laser-equipment-certification standard (Class I). According to the recommendations of the American National Standards Institute, the use of such equipment does not require any radiation safety control measures or medical surveillance. The instrument is shown in the normal operating mode. The laser system is enclosed under the fully interlocked cover A , where the rotating turntable that holds the disc under test is also located. The turntable shown on the left side of the instrument is synchronously rotated and radially advanced with the test disc. It provides a plotter bed for an automatic pen that records the defect locations. With this instrument, all defects that are larger than approximately one groove width can be counted and their locations can be automatically plotted in less than 5 minutes.

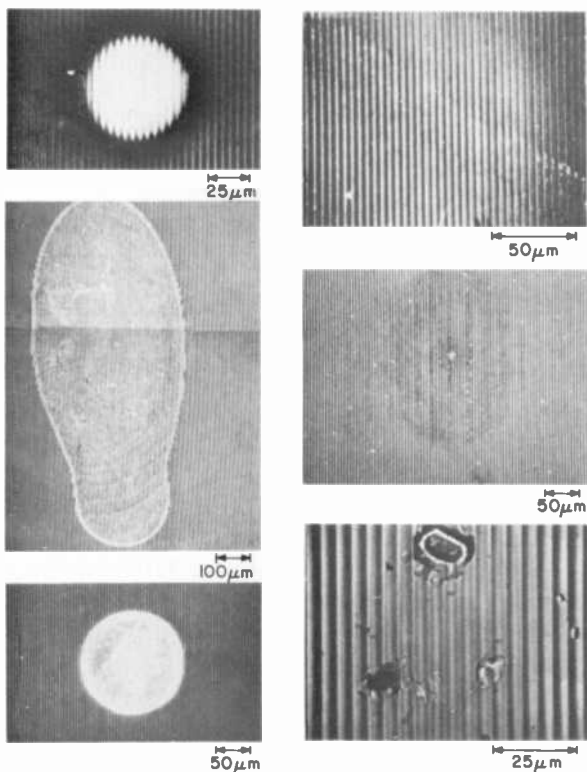

Fig. 12—Photomicrographs of representative defects on an experimental disc that were automatically located by a defect detector.



Fig. 13—Photograph of a defect detector developed for routine production control (A is the fully interlocked cover for the laser system).

4.2 Groove and Signal Depth Measurement

Another instrument that makes use of the information contained in the far-field diffraction pattern is the diffraction spectrograph. Diffraction spectrographs were developed to provide the means for rapid measurement of groove and signal depth. Such measurements are required especially during disc replication, where process errors may lead to discs with shallower features than those present on the stamper. Also, for lubricated discs, diffraction spectrographs can be used to determine the thickness of the lubricant layer in the grooves. Prior to the development of diffraction spectrographs, VideoDisc microgeometry could only be determined by electron microscopy. Electron microscope measurements usually are performed on small samples that are prepared by cutting up a disc or stamper. Current versions of the diffraction spectrograph provide a very rapid and accurate method of depth measurement; they can be used to prepare continuous plots of groove and signal depth as a function of disc radius and azimuth in less than 5 minutes per disc surface.

To understand the operation of the diffraction spectrograph, again refer to Fig. 10 and assume that a weakly focused laser beam is illuminating several grooves on the disc surface. Also, we note that for typical discs the groove depth is $0.3 \mu\text{m}$ and the signal depth is $0.07 \mu\text{m}$. For visible light illumination, the optical power diffracted into the continuous signal spectra is much smaller than that contained in the discrete groove spectra. Then the optical phase change at the disc surface experienced by light reflected from the discs can be approximated by

$$\phi(z) = \sum_m \phi_m \sin \left(2\pi m \frac{z}{G} + \psi_m \right), \quad [10]$$

where $\phi(x)$ is a Fourier series expansion of the periodic groove pattern, ϕ_m is the m th coefficient of the expansion, ψ_m is the phase of the m th term, G is the groove-to-groove spacing, and z is the distance variable along the radial direction of the disc. Following the standard treatment of phase gratings, the amplitude reflection coefficient can be written from Eq. [10] as

$$R(z) = \prod_m \left[\sum_n e^{i\xi_{m,n}(z)} J_n(\phi_m) \right], \quad [11]$$

where the phase factor $\xi_{m,n}(z) = \psi_m + (2\pi mnz/G)$ and J_n are Bessel functions of the first kind. In general, the far-field amplitude distribution

is related to the aperture-field distribution by Fourier transformation. If the illuminating beam is sufficiently large, the far-field diffracted-wave amplitude distribution can be obtained by Fourier transforming Eq. [11], and the intensity distribution in the diffraction pattern is given by the absolute square of the far-field amplitude distribution. If the groove cross section is well approximated by a sine wave, then in Eq. [10] the only nonzero coefficient is $\phi_1 = 2\pi\lambda/d$, where d is again the groove depth. For such sinusoidal grooves, the diffraction pattern intensity distribution is easily calculated and the power in the n th diffraction order is found to be

$$P_n = P_o J_n^2(2\pi\lambda/d), \quad [12]$$

where P_o is the incident laser power.

Early versions of the diffraction spectrograph used a scanned photodetector for the measurement of the diffracted power distribution. A typical scan of the diffraction pattern of an experimental disc is shown in Fig. 14. By computer fitting the measured spectrum to the expression given in Eq. [11], the groove depth of the disc under test was found to be $0.2965 \mu\text{m}$, and the root-mean-square error in fitting the order in-

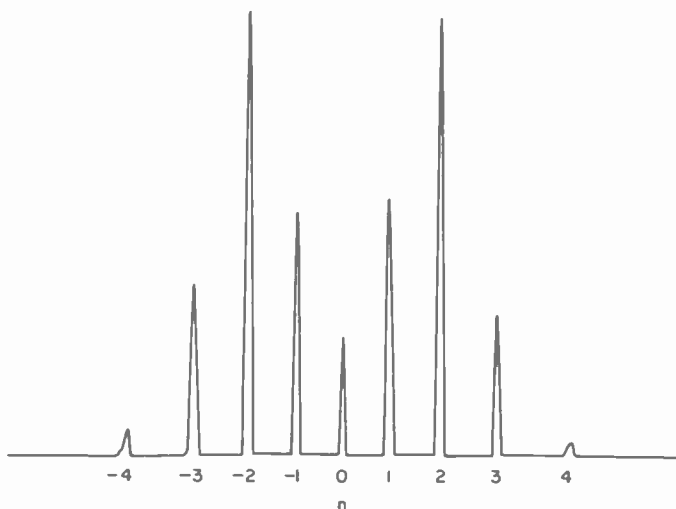

Fig. 14—Groove diffraction spectrum measured with a scanning diffraction spectrograph.

tensities was $\epsilon = 2 \times 10^{-3}$. The error is defined as

$$\epsilon = \left\{ \frac{1}{n} \sum_n \left[rM_n - \frac{C_n}{\sum_q C_q} \right]^2 \right\}^{1/2}, \quad [13]$$

where M_n is the measured order intensity, C_n is the best-fit order intensity calculated from Eq. [12], and r is an adjustable scale constant.

The groove shape of standard electromechanically mastered discs is not well approximated by a simple sine wave. Such discs are produced with V-shaped grooves and their proper analysis requires the retention of several terms in Eq. [10]. Even though in this case the mathematical formalism outlined above becomes rather complex, the algebra is straightforward. The fit of the experimental V groove data to the theoretical distribution was found to be very good, with a root-mean-square error again less than 10^{-2} .

Signal-depth estimation from the diffraction pattern is based on the following concepts. First, the shallow signal slot shape is approximated by a sine wave. Second, because the signal elements in adjacent grooves have approximately equal depth, the diffraction continua in Fig. 10 can be viewed as the diffraction pattern of a set of parallel, incoherent, narrow gratings of equal depth. Then it can be shown that a good depth estimate is obtainable by treating the sum of the powers in all groove orders as the 0th order signal beam and the power in the two continua as, respectively, the +1st and -1st diffraction orders in a sinusoidal phase grating approximation. The agreement of scanning electron microscope and diffraction measurements of groove depth was found to be within approximately $0.005 \mu\text{m}$.

Several versions of diffraction spectrographs have been built and installed in the pilot disc production facility. Current versions use an array of stationary detectors and on-board logic that performs several fitting calculations per second. These instruments are extensively used to determine the effects on signal and groove reproducibilities of pressing and compounding process parameters.

4.3 Cutter-Head Displacement

The most recent addition to the family of optical systems that are used to perform process-related measurements in the VideoDisc program is a unique high-resolution interferometer. This instrument is a modification of a system that was originally developed for the study of ultrasonic wavefronts.⁸

This interferometer is used to evaluate cutter heads developed for

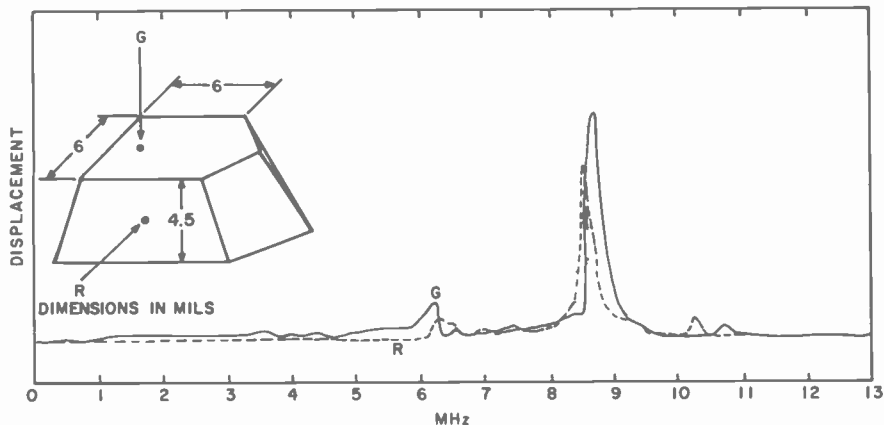

Fig. 15—Experimental cutter head transducer movement measured interferometrically. The peak of trace G corresponds to approximately $0.002 \mu\text{m}$ peak-to-peak transducer displacement.

electromechanical recording. It allows the direct measurement of cutter-head displacement under rf drive conditions. Typical plots of the peak-to-peak displacement of an experimental piezoelectric cutter-head transducer as a function of drive frequency are shown in Fig. 15. Trace G is the displacement along the direction of transducer excitations and trace R is that perpendicular to it. The approximate dimensions of the transducer tested were $150 \times 150 \times 110 \mu\text{m}$. The peak of trace G corresponds to approximately $0.002 \mu\text{m}$ peak-to-peak transducer movement. Even though capacitive techniques can be used to measure the axial movement of bare transducers, this instrument provides the only known means to measure the three-dimensional movement of complete cutter heads.

Acknowledgments

Many researchers at RCA Laboratories have contributed to the work described in this overview paper, which contains many previously unpublished results. The principal contributors were the key members of the VideoDisc Optical Techniques Team: C. B. Carroll, K. F. Etzold, A. H. Firester, M. E. Heller, W. R. Roach, J. P. Russell, P. Sheng, and W. C. Stewart. I thank all members of the Optical Electronics Research Group at RCA Laboratories who have, without exception, assisted in this effort. The success achieved by the Optical Techniques Team would not have been possible without the close cooperation and help of all teams in the VideoDisc effort.

References

- ¹ W. C. Stewart, "On Differential Phase Contrast with an Extended Illumination Source," *Opt. Soc. Am.*, **66**, No. 8, p. 813, Aug. 1976.
- ² A. H. Firester, M. E. Heller, and P. Sheng, "Knife-Edge Scanning Measurements of Subwavelength Focused Light Beams," *Appl. Opt.*, **16**, No. 7, p. 1971, July 1977.
- ³ A. H. Firester, I. Gorog, C. B. Carroll, M. E. Heller, J. P. Russell, and W. C. Stewart, "Optical Readout of the RCA VideoDisc," CLEOS '78 IEEE/OSA Conf. on Lasers and Electro-Optical Systems, San Diego, Calif., Feb. 7-9, 1978.
- ⁴ I. Gorog, P. V. Goedertler, J. D. Knox, I. Ladany, J. P. Wittke, and A. H. Firester, "Information Scanning Technology: Applications of CW AlGaAs Injection Lasers," *Appl. Opt.*, **15**, No. 6, p. 1425, June 1976.
- ⁵ J. K. Clemens, "Capacitive Pick-up and the Buried Subcarrier Encoding System for the VideoDisc," *RCA Review*, **39**, No. 1, p. 33, March 1978 (this issue).
- ⁶ H. Kressel and F. Z. Hawrylo, "Red-Light-Emitting Laser Diodes Operating CW at Room Temperature," *Appl. Phys. Lett.*, **28**, No. 10, p. 598, 15 May 1976.
- ⁷ I. Ladany and H. Kressel, "Visible CW (AlGa)As Heterojunction Laser Diodes," Int. El. Dev. Meeting, Wash., D.C., Dec. 6-8, 1976, paper No. 6.4, Conf. Proc., p. 129.
- ⁸ R. S. Mezrich, K. F. Etzold, and D. R. Vilkomerson, "System for Visualizing and Measuring Ultrasonic Wavefronts," *RCA Rev.*, **35**, p. 483, Dec. 1974.

VideoDisc Testing Philosophy and Techniques

W. J. Gordon

RCA SelectaVision, Indianapolis, In.

Abstract—This paper reviews the testing techniques utilized at various stages of VideoDisc manufacturing. Procedures and equipment used to evaluate submicron defects and dimensions at both research and production levels are discussed. Test methods to simulate environmental extremes of product use are reviewed. A brief discussion of factors determining sample size selection to assure high confidence levels for statistical data is presented.

Introduction

Throughout the evolution of VideoDisc development many test techniques have been used to evaluate performance characteristics. Presently more than 19 kilometers (12 miles) of groove with signal elements recorded at wavelengths of less than 1 micrometer provide approximately one hour of program material on each side of the disc. Once initial development is complete, the primary task of testing operations is to ensure acceptable product performance for the consumer's application. For the VideoDisc, these tests must take into account the player/stylus characteristics, product life, and environmental conditions. However, testing only the finished product under actual consumer conditions would result in equipment, manpower, and yield inefficiencies that would be economically prohibitive. Therefore, various process control tests are being used to establish product integrity and allow classical sampling plans to be used.

A highly simplified description of the basic process steps for disc manufacture is shown in Fig. 1. The program material is first recorded

on a metal master, which is the source of the many replication steps necessary for high-volume production capability. The first type of replication is made by an electroplating ("matrix") process that ultimately generates a large quantity (typically 100) of nickel stampers. Pairs of

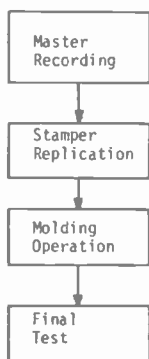

Fig. 1—Manufacturing processes.

stampers containing appropriate program materials are then selected for molding the vinyl discs. More detailed information describing these processes is contained in other articles in this issue¹ of RCA Review.

Matrix Testing

Ideally each replication step will be an exact reproduction of the physical signal and groove characteristics of the master. This also means, however, that any imperfections that may have been on the original part or that are created in an individual process will become permanent ("pattern") defects on all parts produced in following processes. Consequently, it is important to have test techniques and procedures that can identify defective metal parts prior to their utilization in molding operations.

While the VideoDisc was designed for capacitive pickup playback techniques, an optical playback system² has been developed for testing metal parts. The use of a laser beam focused by an air-bearing controller has provided a noncontact, nondestructive test system (Fig. 2) that plays back the recorded signal information for subjective evaluation. This type of test ensures that the signal-processing equipment is functioning properly during the recording of the master.

Physical recording dimensions of the master are checked by use of a Scanning Electron Microscope (SEM). Since only small samples can be placed in the sample chamber, a test replication of the master is made

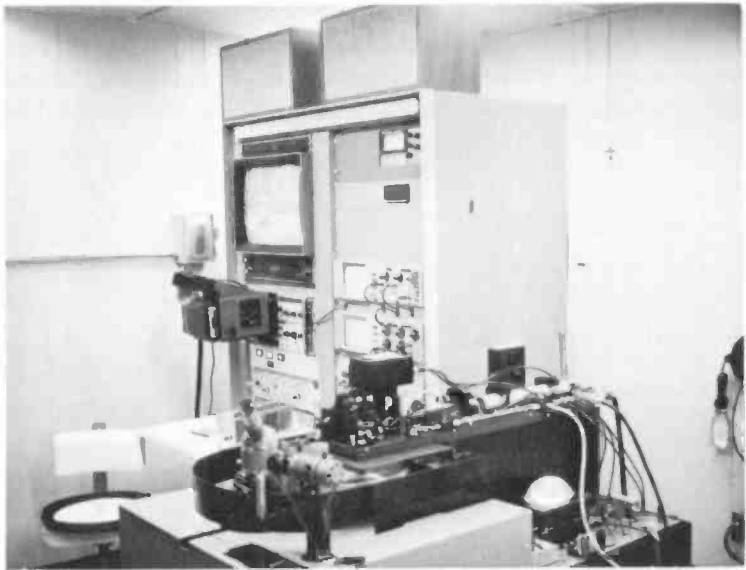

Fig. 2—Laser playback system

for punching out selected test areas. By analyzing the special test signals in these areas, the physical dimensions of the recorded signal can be measured. An SEM photograph of the groove and signal structure of an electromechanical recorded master is shown in Figure 3.

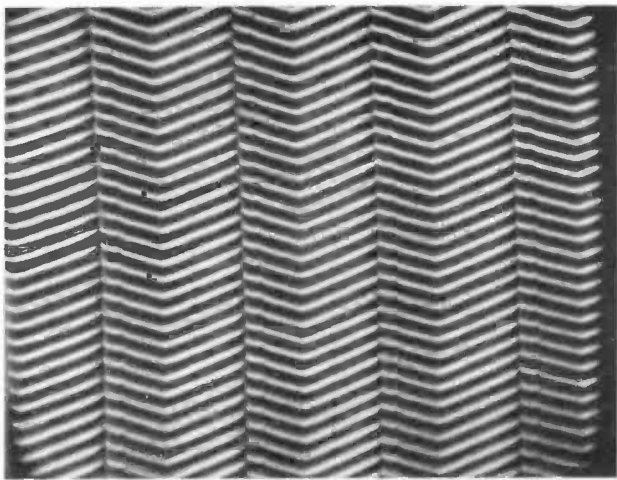

Fig. 3—Recorded groove structure (approximately 6,500 X).

Discrete defects can be formed in the electroplating process by solution problems and debris contamination. Many of the defects caused by solution and other plating problems can be detected by a visual inspection using grazing high-intensity light. This technique provides a simple, but effective, process control test. Some of the defects that can be generated by debris contamination are very small and cannot be detected by visual

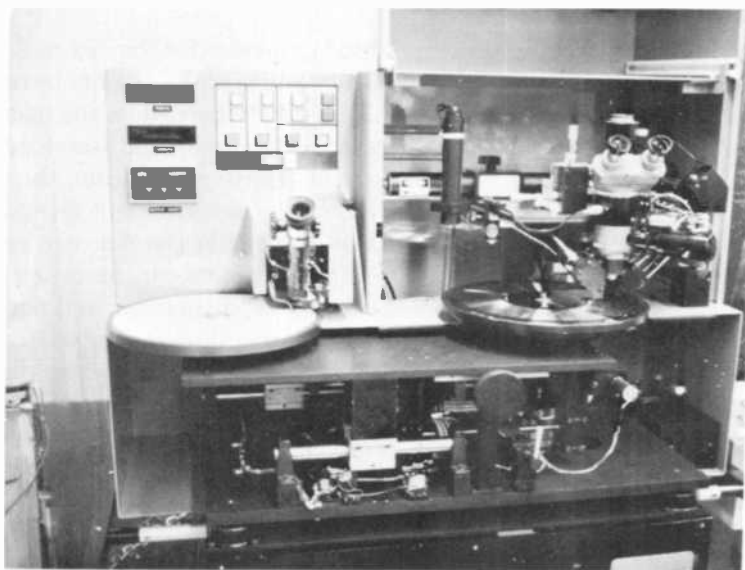

Fig. 4—Laser defect detector.

techniques, yet cause significant playback problems. Another type of laser test system has been developed for inspecting metal parts for these microscopic defects. The laser defect detector shown in Fig. 4 has the capability of testing a metal part with one hour of program material in only three (3) minutes. This test speed is achieved by sensing the diffraction characteristics of a reflected laser beam which tests more than 100 grooves at a time. Any irregularity is detected and its exact radius and angle location recorded for further analysis.

Using the above tests, a high confidence level is achieved for the metal parts produced in the master and matrix processes. One final test is made by making a sample press run to test the playback quality with a capacitive stylus. Special test signals called "basebands" located at the end of the program material are used to check disc/stylus system performance. Spectrum analyzer measurements are made to determine im-

portant system characteristics such as carrier level, frequency response, signal-to-noise ratio of the video carrier, noise spectrum, etc. This type of test provides technical information on how well the original signal information is transmitted through the replication medium and detected by the stylus pickup.

Press Run Evaluation

The metal parts (stampers) are mounted in presses for the disc molding operation. It is important that the groove and signal elements be replicated as closely as possible to the information recorded on the master. The efficiency of this process is affected by the setup and stabilization of various process conditions. During the molding operation, the disc is also subject to a number of effects that may produce defects; and, as with all plastic materials, stress variations within the disc can cause physical distortions to occur. In addition, defects can be caused by compound contaminants, melt flow variations, dispersion, and nonuniformity. The normal rotational speed of the disc during playback is 450 rpm. This speed, along with stylus compliance requirements, places special importance on obtaining good molding characteristics. Because of these problems, much effort has been expended in equipment and materials research, development, and selection required to provide the process conditions necessary for good product performance.

Several techniques are used to provide adequate capability of the molding process. As with the matrix process, a simple visual inspection has proven effective for identifying many molding problems such as stains, voids, and stamper damage. An instrument using noncontact capacitance probes (Fig. 5) is used to monitor the vertical displacement of the disc surface at two radii. The display indicates peak-to-peak vertical displacement and peak acceleration per revolution at each radius. From this data, bowing or dish warp can also be determined. It is equally important that the grooves on both sides of the disc be concentric with the disc center hole. For this reason the center hole is molded and pre-aligned in the press rather than punched in a separate process. The system in Fig. 5 also has an optical pickup for measuring horizontal TIR (a measure of centering). The proper control of both vertical and horizontal disc displacements is needed to maintain good sync stability, color correction, and stylus tracking during playback.

A third type of laser test capability has been developed for measuring the replication efficiency of the molding operation. This system measures the relative amplitude of the diffraction orders of a low-power reflected laser beam. This data is then used to calculate how well the groove and

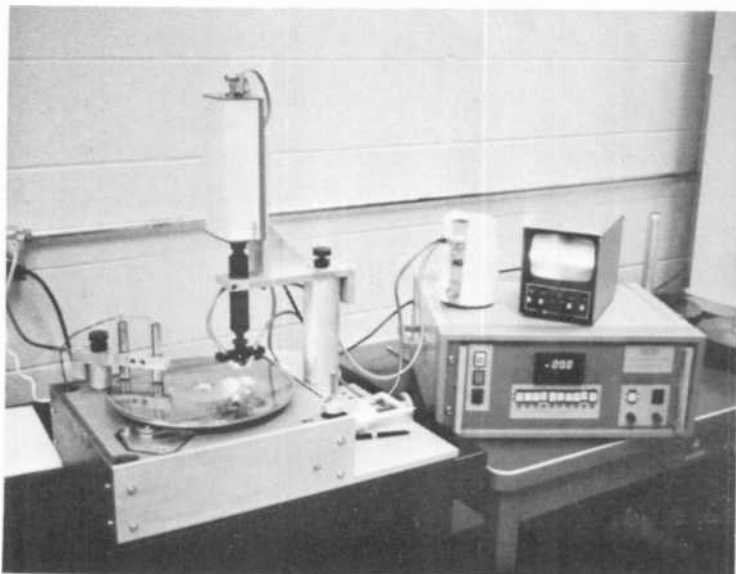

Fig. 5—Warp/TIR test station.

signal is replicated in the vinyl surface. The results show the groove and signal-element depths in angstroms or percent replication of the metal stamper at three different radii on the disc.

Final Testing

All of the test techniques discussed thus far have been designed to check various physical characteristics of the major processes at low-volume points or with high-speed systems in order to produce quality product at a minimum cost of testing. Since none of these tests actually simulate the playback system to be used by the customer, some level of playback testing must be done to verify product quality for consumer acceptance criteria. However, the process control tests make it possible for playback tests requiring two (2) hours per disc to be made with a small number of samples and still maintain a high confidence level in product quality.

A special test station used for playback testing is shown in Fig. 6. These test stations are instrumented to continuously measure dropouts, stylus skips, carrier level, video signal-to-noise ratio and a quantity called carrier distress. Dropouts (Fig. 7) are a loss of signal information and can be caused by a process defect on the disc or by stylus/disc interface separation during playback. The duration and repetition rate of these



Fig. 6—Playback test systems.

defects determine whether or not the picture quality would be objectionable. The RCA VideoDisc player can compensate for typical defects of this type by using video substitution techniques if their duration is less than one horizontal scanning line. However, if the signal loss is

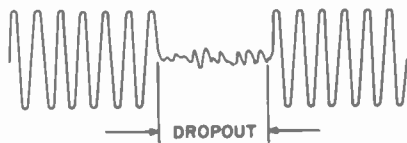

Fig. 7—Dropout of signal information.

longer, or if shorter ones occur too frequently, deterioration of the picture will result. The testers have the capability of detecting the dropout activity during playback and printing out information about defect duration and frequency of occurrence.

Carrier distress is the accumulated total of the number of seconds in a given length of play that the carrier level falls below a preset threshold at which some loss of picture quality would become evident. It has proved to be a sensitive indicator of a wide variety of problems that may afflict the disc or stylus. For instance, a disc from a bad batch of compound or one that has some failure of its lubrication may generate small quantities of debris which get under the stylus and cause some reduction of signal level. Even though this loss of signal may not be sufficient to trigger the dropout compensator, its presence is evidence of an undesirable condition. Our discs are judged against a standard that calls for no more than a few seconds of carrier distress in a full 60 minutes of play.

Testing for stylus mistracking that results in forward or reverse skips by the stylus is accomplished by a test signal that is added to the program material during the vertical interval. This signal is a digital code that numbers each revolution of the recorded groove. The tester reads the codes and determines how well the stylus is tracking in the groove and if not, whether the skip was in the forward or reverse direction. Another important use of the groove identification code is in determining the exact location of defects, which then can be accurately traced back to the disc and metal parts during microscopic defect analysis procedures. Video signal-to-noise measurements are made using commercially available instrumentation utilizing comparative noise level techniques. A CCIR standard filter is used for this measurement to obtain a weighted signal-to-noise value that represents subjective opinion ratings of TV receiver characteristics.

Each test station has a video monitor for subjective picture quality evaluation. It can automatically record the type and location of picture problems that are identified by the operator.

Environmental Testing

Based on past experience with audio records and with various VideoDisc yield tests, it is apparent that the VideoDiscs will be subjected to a wide variety of environmental conditions. The disc should be capable of surviving all reasonable environmental conditions without suffering significant damage to itself, causing subsequent damage to the stylus, or adversely affecting playback performance. "reasonable" conditions include those environments normally encountered in distributor ware-

houses, handling, shipping, retail outlets, and the consumer's home. These reasonable conditions also take into consideration the typical environments of different geographic locations such as hot, humid seashore areas, hot, dry desert areas, or industrialized areas where pollution may be a factor. These conditions are all carefully considered in evaluating the probability that the disc will withstand these conditions with no adverse effects over a significant length of time.

Clearly, the goal of product testing is to simulate the effects of these environmental conditions, to determine the ability of the discs to survive them, and to provide inputs for improvements in disc characteristics where survival is least favorable.

Although the disc will normally be played within an ambient temperature range of 16 to 32°C (60 to 90°F), it can survive extremes as low as -29°C (-20°F) and as high as 54°C (130°F). Discs subjected to temperatures outside the normal playing temperatures must be able to be reaclimated to in-specification dimensions within a reasonable length of time. Experience has shown that discs subjected to -23°C (-10°F) for two or more hours can be expected to change dimensionally (so as to produce inaccuracies in stylus set-down) and can shatter if dropped before the disc is allowed to stabilize at "room" temperature for several hours. Similarly, higher than normal temperatures can cause disc expansion and changes in warpage characteristics until the disc is re-stabilized in the normal play temperature range. These conditions are typical for all PVC discs, including audio records.

To determine the ability of discs to be played at the limits of the operating temperature and humidity ranges (typically 10°C and 32°C, 10% and 90% relative humidity), wear tests are conducted inside instrumented environmental chambers. Humidity may be particularly insidious. Unless precautions are taken, disc and stylus wear can be affected by very high or low relative humidity when the disc is played. Humidity in the air can condense on the disc surface and cause dust and other contaminants to adhere to the disc playing surface. To simulate these conditions in the laboratory, an extensive analysis was made of typical dust encountered in consumer locations. This has resulted in a standardized range of sizes of dust particulates. Application of dust simulates an exposure of 1-5 years in a typical home and is controlled closely in regard to uniformity of application and repeatability. This is followed by exposure to a temperature and humidity stress (typically 29°C, 90% R.H. for 44 hours) prior to playback wear tests.

The use of a protective disc cover, called a caddy, significantly reduces the effect of airborne dust on videodisc performance. Experience has shown that dust, fingerprints, scratches, and other contamination could

degrade disc performance. Fingerprints, particularly, were demonstrated to cause serious long-term wear and playback problems on early types of coated discs. Clearing the discs (as is now commonly done with audio records) was effective but was a less desirable alternative than the "caddy" approach to disc protection.

Components of the disc must also be relatively unaffected by "aging" or changes in performance characteristics with time. Although the use of accelerated stress tests involving temperature and humidity cycling

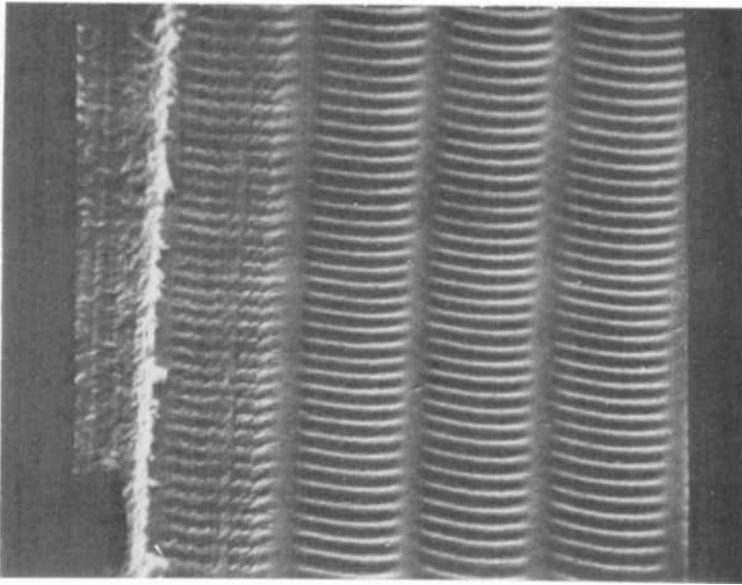

Fig. 8—SEM photo of worn area of disc (4000 X).

can give at least some indication, it has been necessary to store discs for extended periods of time under semi-controlled conditions and in caddies. These tests normally range from 6 months to several years and involve comparisons of playback initially and after the storage period. Analysis is made of changes in dimensions, warpage, vertical acceleration, "dishing", and analytical measurements (IR, X-ray fluorescence, etc.) to determine compositional stability.

Wear testing is an important measure of the ability of the disc and stylus to perform reliably in the consumer environment. In many cases, wear tests are performed after discs have been subjected to temperature-humidity, dust, or other stresses. Figure 8 shows what can happen to the grooves of a worn disc. This wear (or "scoring") is severe enough

to cause loss of video and audio information, and can sometimes cause (or be caused by) stylus failure. Reference [3] discusses how the stylus contributes to this phenomenon and how it can be reduced by stylus design considerations.

Wear tests are significant in determining the stability of the disc-stylus interface. This may be monitored by signal analysis throughout the test, by analyzing the condition of the disc surface before and after test, and by determining the initial and final condition of the stylus tip. In general, these tests are performed with any of several different wear-testing methods, which include:

N × 3 Wear Tests—This test simulates a “normal use” condition in which a stylus plays each new disc 3 times. (*N* can represent any quantity of discs.)

1 × 50 Wear Tests—This test simulates repeated plays of the same disc with the same stylus. While it is predominately a durability test for the disc, stylus wear rates are also obtained.

Interchangeability Wear Test—This test simulates the conditions of multidiscs and multi-styli being played interchangeably.

As indicated previously, these wear tests are usually conducted in conjunction with various types of stresses.

Test Controls and Statistical Data Analysis

Due to system requirements of all playback tests, a majority of testing must be conducted under carefully controlled conditions to prevent extraneous effects from dominating test results. At the same time, the wide diversity of consumer environments must be considered. Test design is, therefore, composed of *two* major divisions. One is concerned with tightly controlled tests to isolate specific problem areas so that they may be corrected (e.g., the determination of disc warpage limits from a player standpoint, environmental ranges, and long-term stability). Secondly, system tests are used in determining the product limitations when it is subject to the broad span of storage/shipping/handling and long-term consumer environment and usage conditions likely to be encountered.

Proper selection of sample size is as important as meticulous control of test conditions. As disc manufacturing processes are brought into better control, larger quantities of discs must be tested to eliminate statistical errors in the interpretation of the result. For example, to be 95% confident in distinguishing between a process condition that produces 40% defective discs and an improved process that produces 20% defective discs, it is necessary to test a sample of 33 discs to confirm the

result. If the process is again refined to reduce the defective to 10%, it is necessary to test 87 discs. Reducing the percent defective to 5% would require the testing of 196 discs, and so on. During 1977 more than 12,500 sample tests were made for disc development and pilot production activities. Of these approximately 5,000 first-play-performance tests were made. Also, more than 2,500 discs were tested under environmental stress conditions requiring another 7,500 plays of verification testing.

A total of 17,700 discs were used in stylus life tests during 1977. In these tests styli were played to the end of their useful life as judged by deterioration of playback performance, because earlier tests had shown that serious errors can be made in estimating stylus life by extrapolating from 20 or 30 hours of wear. Finally in 1977 some 3,900 discs were tested in a variety of exploratory investigations of lubricant and compound variations.

Conclusion

The test philosophies used for VideoDisc testing are quite typical of many other video and audio communications products. Test objectives must be adequate for both product development and manufacturing goals. Some of the test techniques used, on the other hand, are unique and are designed to test specific playback characteristics. During the disc development stages much experience has been obtained in the application of the techniques described here and in the development of new improved techniques. Equipment for these testing applications has been designed and constructed by various groups within RCA to meet specific testing goals of ensuring quality performance of the VideoDisc.

Acknowledgments

The writer wishes to acknowledge the many contributions from the staff of VideoDisc Manufacturing and Engineering at RCA Indianapolis, and to give special acknowledgement to J. W. Stephens, Manager, Test and Development and R. H. Huck, Senior Member, Engineering Staff.

References:

- ¹ R. J. Ryan, "Materials and Process Development for VideoDisc Replication," *RCA Review*, 39, p. 87, March 1978.
- ² I. Gorog, "Optical Techniques Developed for the RCA VideoDisc," *RCA Review*, 39, p. 162, March 1978.
- ³ R. N. Rhodes, "The VideoDisc Player," *RCA Review*, 39, p. 198, March 1978.

The VideoDisc Player

R. N. Rhodes

RCA Laboratories, Princeton, N.J. 08540

Abstract—Using an engineering developmental model as an example, the various goals, functions, and most significant requirements of a VideoDisc player are described. The protective disc cover, called the caddy, is discussed and data concerning its effectiveness are presented. Construction details indicative of the relative simplicity and freedom from critical tolerances of the mechanical concepts are described, and a block diagram analysis of the electronics with some details of the signal-processing and time-base-correction systems is presented. The design goals for the stylus and the techniques to achieve them are discussed.

I. Introduction

The VideoDisc player, which is described in this article, is a pre-production engineering model that, for purposes of identification, bears the model number SDT200W. The functions that it performs are typical of those required to reproduce the recorded signal, and as such it will be used as a vehicle for describing those functions and requirements. It is shown in Fig. 1. Its overall dimensions are 25 inches wide by 17 $\frac{3}{4}$ inches deep by 6 inches high, and it has a power requirement of 60 W. It represents approximately the sixth player design iteration and was built in modest quantities. In total, over 430 complete player instruments have been fabricated and tested. Throughout these iterations it was clear that the players bore a resemblance to their cousins the audio record players in both form and function. The principle differences stem from the several hundredfold increased density of information required on a video disc, and the concomitant need for higher precision and care in disc handling. Nonetheless, the simplicity, low cost, and reliability of the basic



Fig. 1—Photograph of SDT200W VideoDisc player.

audio players were kept in mind as design goals and have been retained. The home video tape recorders now starting to appear on the market also had to be considered in establishing design goals. It seemed both possible and desirable to design a VideoDisc player with less than half as many parts as a home video tape recorder and with far fewer parts having critical tolerances, so a manufacturing cost could be achieved that would be less than half that of the magnetic tape machines. Insofar as performance goals are concerned, it was decided early that if the disc, the player, and the TV receiver were considered as a system, the player should never be the limiting factor.

From the point of view of the user, the required physical functions are, first, to get the disc onto the turntable in a convenient manner—in the SDT200W this is done by means of slot loading; second, to start play and have sound and picture appear on the TV receiver in a short time without the need for adjustments by the user; third, to track accurately throughout an hour or so of play time; and fourth, to have the disc in a position to be removed shortly after end of play. For user convenience several other functions were added; STOP which permits terminating play at the user's discretion, PAUSE which interrupts play but provides that play start again at the point of interruption upon release from PAUSE, and FORWARD and REVERSE SEARCH which, in combination with a playing time indicator, permit the user to go directly to a desired portion of the disc. These functions have been incorporated into the player designs for some time now, with each succeeding design iteration bringing improvements in performance, reliability, serviceability, etc., as understanding and technology developed. However, the most

obvious recent departure was the use of caddies for protection and convenient handling of the disc, and the corresponding player modifications to permit slot loading of the discs-in-caddies.

2. Caddy

Principally because of their extremely high information density, the performance of video discs is inherently more sensitive to warp, dust, abrasion, fingerprints, spillage, etc., than are audio discs. It should be noted, however, that they are not unduly delicate as compared to other visual media, such as movie film, slides, and video tape. To alleviate the handling problem, a number of disc packaging systems were investigated, culminating in the development of a system in which the user never handles the disc itself under normal circumstances. The package is called the caddy and it comes in two parts as shown in Fig. 2. The outer cover, or sleeve, of the present caddy is made of molded low-cost plastic having



Fig. 2—Photograph of caddy system.

dimensions of approximately $12 \times 13 \times \frac{1}{4}$ inch. Care was taken in materials selection and in processing to assure that the finished sleeve is flat to within 15 mils (0.4 mm) and will remain so during shipping and over a temperature range of from -20°F to 130°F . The inner element consists of the end closure and a hoop that encircles the disc. This element is called the spine and it remains with the disc throughout the play cycle and in storage. Side 1/Side 2 information is printed on the spine and is visible to the user through cutouts in the sleeve. Consequently, regardless of which side of the outer cover, or sleeve, is up during disc retrieval, proper side identification is preserved. In addition to physically protecting the disc, the sleeve has narrow strips of soft material running across its width near its opening. These serve two functions. First they reduce dust entry into the sleeve, particularly when the disc is out of the sleeve, and second they gently wipe the disc during insertion and retrieval. The overall effectiveness of the caddy system is quite high as can be seen in Fig. 3 which shows the particle size distribution on the outside of the caddy and on the disc after a simulated one-year exposure to typical home dust.

Having found an effective disc protection system, other advantages

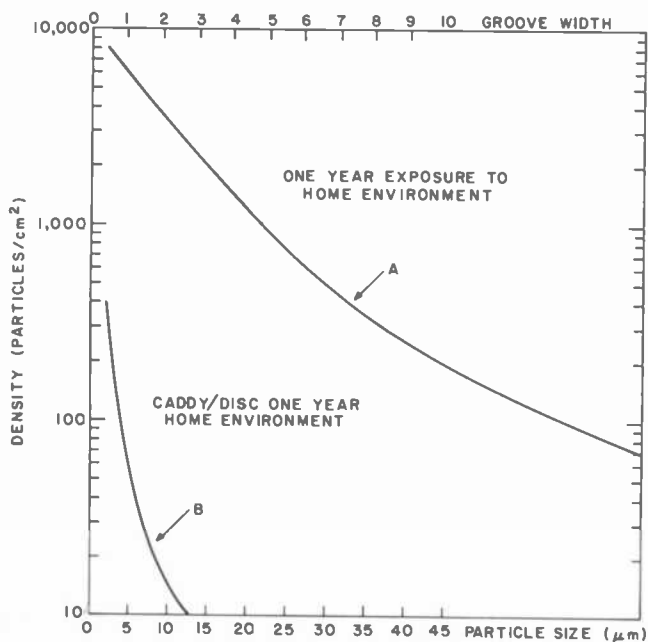

Fig. 3—Analysis of dust accumulated in 1-year simulated exposure to typical home environment. Curve A shows dust on outer cover and curve B shows dust on disc protected by caddy.

accrued. First because of the slot loading, the video player does not use the raisable lid or dust cover familiar on audio instruments. This has a number of advantages in user convenience, particularly for placement of the instrument in the home. It can be put on shelving spaced as close as 7 inches and at a wide range of heights. Second, the inside of the player is kept free of dust or other debris. Third, it has been found that a properly executed caddy-disc-player system is easier for the consumer to use than the normal audio phonograph procedures. Simple mechanisms have been developed for the extraction of the disc from its caddy inside the player and its reinsertion at the end of play. The added cost of these mechanisms is essentially balanced by the removal of the costly decorative items required in the disc compartment of an open-lid design.

3. Construction Details of the Player

Considerable care was taken in the design of the player to achieve high reliability and to avoid the use of close-tolerance parts. To this end, all mechanical tolerances in the STD200W are typical of those used in audio products. In die cast, sheet metal, and plastic parts this is generally in the range of ± 5 to 10 mils (0.13 to 0.25 mm). In shafts and bearings this is typically 0.0002 to 0.001 inch (0.5 to 25 μm).

In addition, an attempt was made to simplify accessibility when service might be required. To this end, the cabinet top is removable upon the release of two fasteners in the rear. The player can easily be made operational in this condition, and most of the electrical and mechanical components are accessible for test and service (see Fig. 4). All major electronics components are on plug-in boards. The turntable is easily removable to permit access to the drive system.

The stylus, which is described in more detail later, is mounted on a light-weight support arm and packaged in a cartridge shell designed for easy replacement by the user with no required adjustment or connections (see Fig. 5). The rear of the stylus support arm is attached to the "arm stretcher" transducer (also described in a later section) by means of a permanent magnet latch. The cartridge shell is held in place in the arm housing by a simple cover. The cover is hinged at the rear and fastened down by two quick-release large slot screws so that cartridge replacement can be accomplished readily without any tools. For protection, the stylus support arm is automatically clamped up inside the cartridge shell by means of a light spring when the cartridge is not in the player.

An exploded view of the player is shown in Fig. 6. The principal elements are the base-pan assembly, mechanism assembly, lift plate assembly, arm housing, and the cabinet.

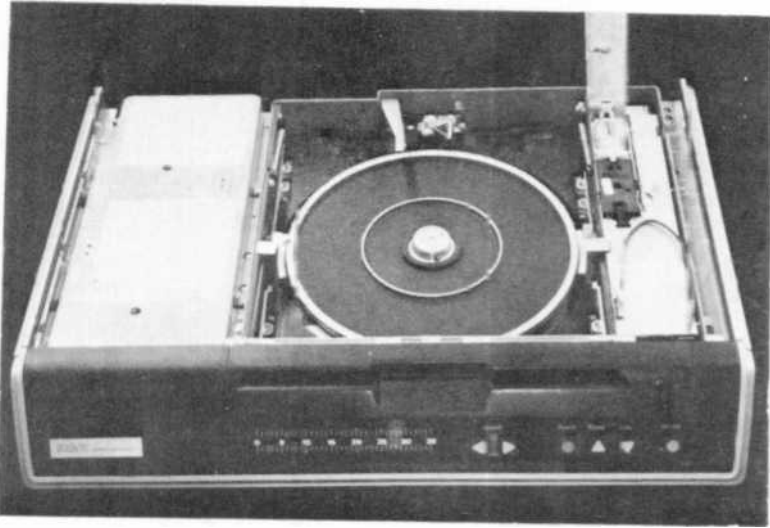

Fig. 4—Photograph of SDT200W with top removed.

Base Pan Assembly (1)

The base pan assembly is the prime uniting item on the VideoDisc player. It provides assembly locations for all other major assemblies, including the electronics and basic mechanism. All wiring harnesses, power transformer (2) fuses, and transmitter (3) are fastened to this subassembly.

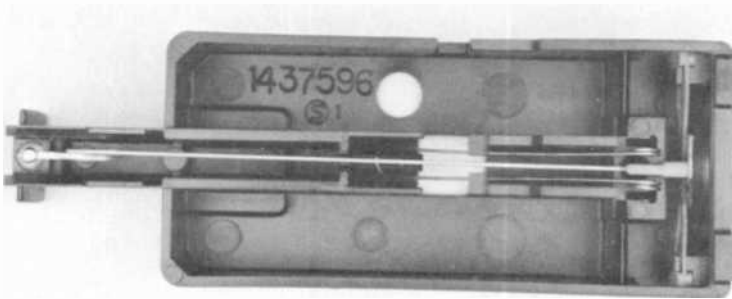

Fig. 5—Bottom view photograph of stylus cartridge.

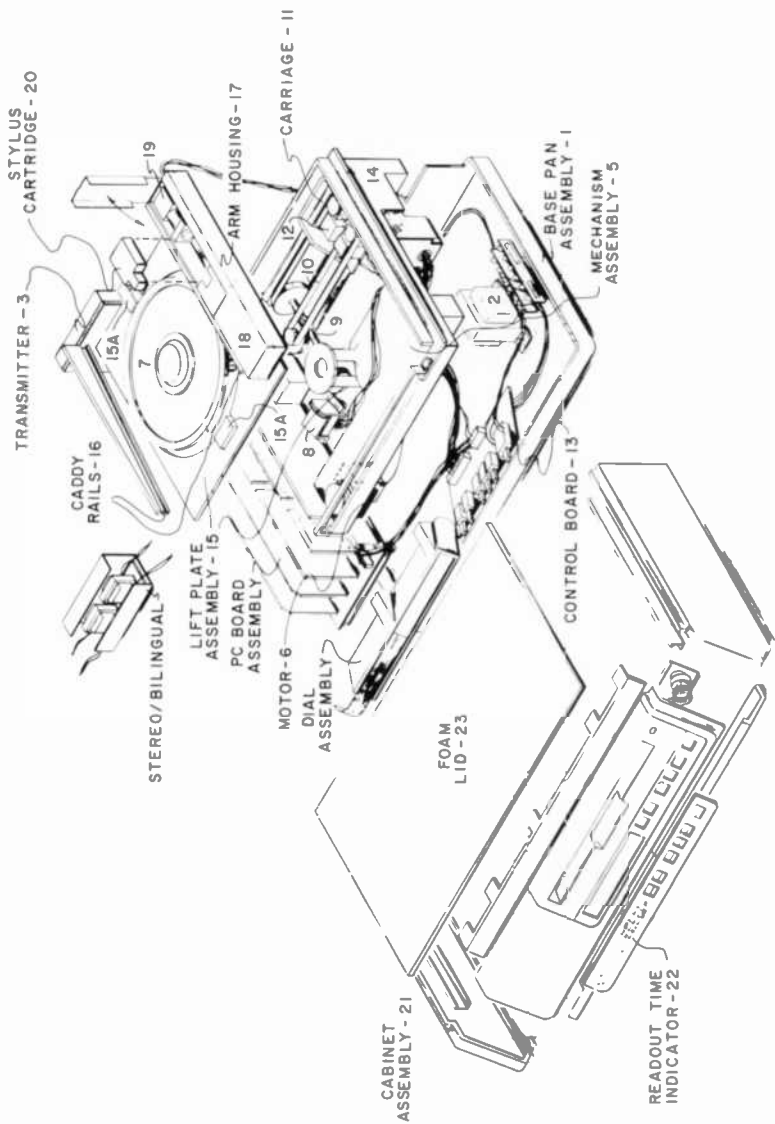

Fig. 6—Mechanical assembly of SDT200W.

Mechanism Assembly (5)

The mechanism assembly is mounted on an aluminum die casting (14) and is the mechanical heart of the VideoDisc player. Included in this unit are the motor (6), turntable (7), and synchronizer (8) drive system. The motor and synchronizer, through a chain of gears and belts (9 and 10), provide the drives for the rotation of the turntable and the motion of the stylus arm carriage (11).

The motor chosen for use in this player is a standard, low-cost two pole shaded pole, synchronous motor. The resilient silicone rubber drive belt couples rotational energy to the turntable. The turntable is designed to rotate at 450 rpm with a tolerance of $\pm 1\%$ in the absence of control. To attain the required exact 450 rpm, control is established by means of a synchronizer coil mounted on the casting that interacts with a 16-pole magnet assembly placed on an inner rim of the turntable. This synchronizer is driven by 60 Hz from the power line. It is loosely coupled physically, but it produces enough torque to overcome the 1% turntable rotational tolerance. The differences in speed between the main drive motor and synchronizer drive speed is absorbed in the silicone drive belt. The turntable shaft provides the motive drive to the arm housing through various gear reduction systems for the search and normal-play modes. The normal-play gear reduction is approximately 15000 to 1 while the search is approximately 100 to 1.

In operation, the turntable comes up to 450 rpm in about 3 seconds, while the arm requires approximately 6 seconds to move from the rest position to the initial landing position. In the search mode the entire recorded band of the disc can be traversed in 9 seconds. The carriage (11), which supports the arm housing (17), is made to drive at the appropriate rates by selectively engaging or releasing of the drive belts mentioned earlier. This is accomplished by three solenoids (12), which receive control signals from the control board (13). A limit switch is employed to prevent the arm housing from carrying the stylus to a point appreciably beyond the inner play radius of the disc in any functional mode. The stylus is automatically cleaned by a bristle brush to remove accumulated debris when the arm housing returns to the rest position.

To protect the stylus, loss of power causes it to retract into the cartridge. This protective action is provided by a stylus arm lifter that is normally in the up position and that allows the arm to fall only when voltage is applied during play functions.

The stylus set-down point can be set accurately in the SDT200W player. It involves tripping a toggle type microswitch. A switch of this type has the unique feature that a switching from one set of poles to another occurs reliably at a given mechanical location. An adjustment is provided that allows this position to be moved slightly such that a very

accurate landing position can be achieved. A typical repeatability after drop and vibration is on the order of 1 second of disc play time. All items in the mechanism assembly are attached to the aluminum diecasting.

Lift Plate Assembly (15)

The lift plate assembly handles the disc before and after play and in all other interface conditions. It is hinge coupled to the die casting, which permits it to assume two positions—an elevated one just below the loading slot during caddy-disc insertion and retrieval, and a lower one, below the plane of the turntable during play. Actuation into either of these positions is accomplished by means of a press bar located below the center of the loading slot. The caddy is inserted spine end first. When it is fully in the slot, the spine is grasped by metal fingers at the rear of the disc compartment. Means for unlocking the spine from the caddy shell are included so that the shell is now free to be extracted. When this is done, the disc rests on lift pads (15A) and is properly positioned so that it will drop correctly onto the turntable when the lift plate assembly is lowered by means of the press bar. The procedure is reversed during disc retrieval. The parts have rather loose tolerances, the most critical being the lift pads, which are adjusted to within 15 mils (0.4 mm) of the turntable to ensure clearance and proper lifting of the disc. Mounted above the lift plate are two injection-molded rails (16) that are aligned with the loading slot and guide the caddy into the proper position. To prevent disc damage the lift plate is interlocked so that it must be lowered before play can begin, and it cannot be raised with the player in the PLAY mode.

The plate assembly mechanism must be capable of raising a rapidly spinning disc, arresting its motion without damaging the disc while maintaining the proper position for caddy insertion. Included in this system are several damper pads that accomplish the deceleration of the disc.

Arm Housing (17)

The arm housing contains the electronics for the generation and initial processing of the signal that the stylus receives from the disc. It also provides the means to place and hold the stylus cartridge assembly (20) accurately. Included in the arm housing is a 915-MHz oscillator, strip-line board, and signal preamplifier (18). To the rear of the arm assembly is located the electromechanical arm-stretcher transducer (19). The arm-stretcher transducer is basically a simple loudspeaker-type assembly in the sense that many of its components such as the Alnico magnet, the powdered-iron support structure, and the coil are standard speaker parts.

To assure alignment, an extension of the coil form is supported by two silicone rubber suspensions about $\frac{3}{4}$ inch apart. Mounted on this extension is the permanent magnet latch, which connects the back end of the stylus arm to the transducer. It is not a very critical device, requiring a smooth frequency response to 3 kHz and a low-frequency resonance of about 65 Hz.

Cabinet (21)

The cabinet is the only part of the VideoDisc player that is considered to be decorative and it is largely injection molded. Since these pieces are defined by Underwriters Laboratories as flame barriers, the plastic used is flame retardant. The readout time indicator (22) is a clear molded plexiglas with secondary silk screened operations applied. The control buttons (13) have the function integrally displayed on the button face. The cabinet parts are subassembled off line and the foam lid (23) sub-assembly is placed on the player as the final operation. This lid is also interlocked so that its removal disconnects all power to the player.

One of the early concerns in the design of slot-loading players related to ventilation for heat removal, especially in view of the need to prevent dust from depositing on the disc while in the player. The control of the temperature inside the SDT200W player was achieved by carefully routing and venting the air flow generated by a fan on the main drive motor. Air is pulled into the main-mechanism casting through air vents located in the rear of this casting, and subsequently through holes located on the instrument back panel. This air is not allowed to flow through the disc playing cavity, so that dirt and foreign material are not allowed to accumulate on the disc surface. The air flow in the lower mechanism cavity cools the synchronizer assembly and removes heat that is transmitted from the electronics package. The air then moves from the mechanism enclosure outside through the electronics package where it is carefully vented at the rear panel directly behind and above the electronics package. The design criterion was that the temperature rise in the disc cavity should be less than 10°F. The temperature rise in the remainder of the player was limited to 20°F rise in the center of the electronics package and 65°F directly on the motor lamination.

4. Mechanical Test

In the initial design of the mechanical portions of the player, components and construction techniques were chosen that would assure a minimum time before service of 1500 hours on limited life items such as turntable and motor bearings. A series of life tests on pilot models to verify the integrity of the design established that, in fact, a mean time before failure

in excess of 2000 hours could be expected for the player mechanism. This compares to 750–1000 hours commonly specified on mechanical audio products such as record changers. In these life tests the pilot players were cycled through the various functional modes and the entire instrument was cycled in temperature through a range of 10° to 148°F. This was continued with a 23 hours on, 2 hour off operation cycle.

In addition, the players were subjected to drop and vibration tests. The player, packaged for shipping, was placed on a vibration test table and subjected to vibrations through the 100 to 300 Hz range at an intensity that caused it to leave the table by 0.06 inch during some part of the frequency range. The test was run for 30 minutes, at which time the player was turned 90° and the 30 minute test repeated. This was followed by a drop test in which the packaged player was dropped on each of its 6 flat edges and one diagonal from a height of 15 inches. After both vibration and drop tests, the players were removed from their packages and checked for visual defects as well as mechanical and electrical performance. This was followed by a complete tear down and inspection at the component level.

5. Electronics

The general approach to the signal processing systems is described by J. Clemens in another paper in this issue of *RCA Review*. The more detailed explanation of the means for carrying it out in the SDT200W can best be followed using the block diagram shown in Fig. 7.

5.1 Signal-Pickup Electronics

In the basic detection system the FM signal transcribed on the disc is read out by sensing the small variations in capacitance between the signal elements of the disc and a thin metal electrode on the stylus face. The metalized electrode is connected to a tuned circuit that is resonant at approximately 910 MHz. The small variations in the capacitance due to the signal elements cause small variations in the resonant frequency and consequently vary the amplitude of a 915 MHz carrier that is injected into the resonant circuit. Amplitude detection of the carrier provides an accurate re-creation of the original FM signal. The amplifier gain is 37 dB and its noise figure is approximately 2 dB. However, the overall noise performance of the pickup system is somewhat poorer than would be represented by that figure due to the noise contribution of the oscillator, which is about twice that of the amplifier itself. The signal sensitivity of the pickup system is such that the noise contribution of the disc is typically 10 dB higher than that of the player. Nonetheless

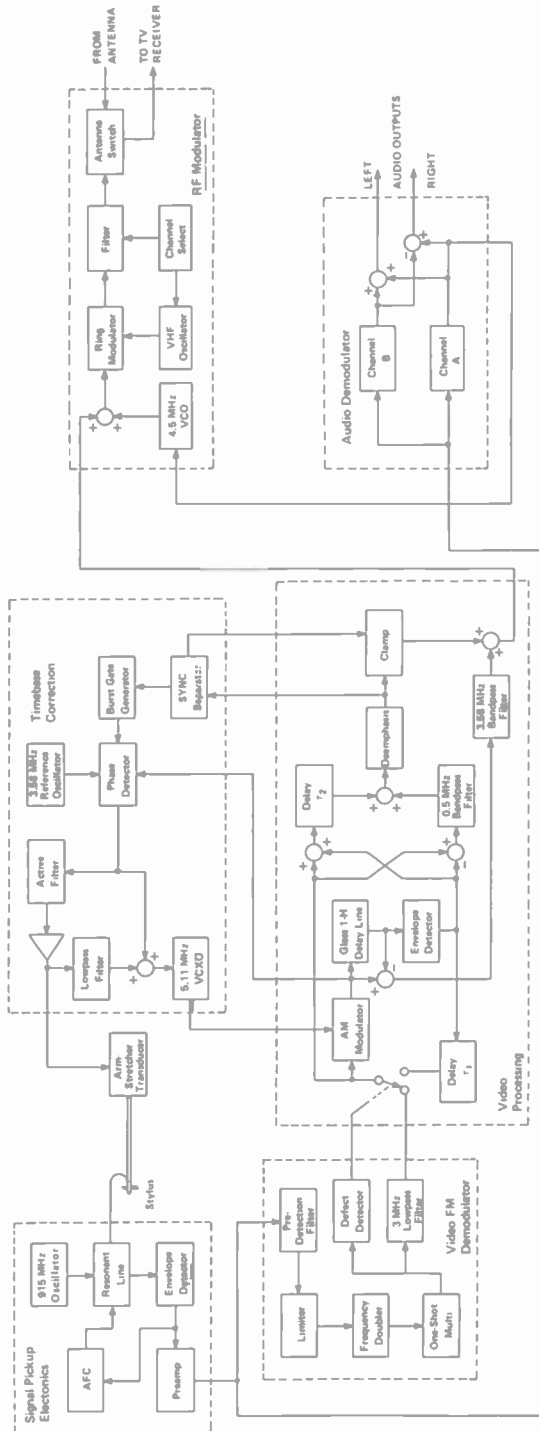

Fig. 7—Block diagram of electronic functions.

the overall weighted S/N is typically 52 dB (see J. K. Clemens' paper).

The AFC on the tuned circuit is used to compensate for variations in stray capacitance during play and when the stylus cartridge is changed. It functions to maintain a prescribed dc detector level which, by design, is consistent with a tuned circuit resonant frequency of 910 MHz. The bandwidth of the AFC is limited to a few kilohertz, so that the detection of the high-frequency video-producing signals from the disc is not affected.

The operating Q is approximately 30. The operating point was placed at the 6-dB-down point in order to provide a more linear amplitude response of the detector, although with a small loss in sensitivity, as compared to operating at the 3-dB point.

5.2 Audio Demodulation

The SDT200W is intended to provide either stereo or monophonic audio signals either to the television receiver or through a "hi-fi" amplifier. Along with the video carrier, there are spaces for one or two audio carriers, which may be recorded on the disc at 716 and 905 kHz. These carriers are separated by bandpass filters and demodulated using phase-locked-loop demodulators. The sound, quality and S/N of a television receiver sound system are generally limited, so that its performance is not significantly degraded even if the player were to use less complicated detectors. However, the additional quieting that is obtained from phase-locked loops makes them the design choice when "hi-fi" drive is intended. On monophonic discs, only the channel A carrier is present, and the channel B demodulator is squelched. When a stereo disc is played, the channel B demodulator produces a difference signal (left minus right), which is matrixed with the sum signal from channel A to produce the left and right outputs.

5.3 Video FM Demodulator

The video FM signal is demodulated by pulse-counting techniques that use self-balancing limiters to ensure suppression of second harmonics. The signal from the preamplifier is filtered to remove the audio carriers below 1 MHz and noise above 9 MHz. Included in the filter is a small amount of fixed high-frequency peaking to equalize the frequency response. The signal is then limited and frequency doubled so that a one-shot multivibrator can be triggered on each zero crossing of the input signal. The resulting equal-width pulses, which represent an FM signal in the 10-MHz band, are averaged by a 3-MHz low-pass filter, producing the demodulated buried subcarrier video waveform.

The pulses are also applied to a defect detection circuit that is the first half of a defect compensation system. This system functions to eliminate drop-outs or other disturbances from the picture by substituting defect-free video when the detector perceives the need. The detector produces a keying signal whenever the period of the pulses is less than 60 ns or greater than 200 ns. When this occurs, it is a clear indication of a defect, since these periods are beyond those resulting from the normal FM signal modulation. The keying signal activates an electronic switch that substitutes stored video from the previous line in place of the faulty demodulator output. The substitute signal is recirculated in the circuit and the performance of the system is such that all defects of less than about 3 horizontal lines duration are effectively removed from the picture.

5.4 Video Processing

The buried subcarrier signal, with its chroma at 1.53 MHz, must be converted to an NTSC format with chroma at 3.58 MHz (see J. K. Clemens paper). To separate the 1.53-MHz chroma from the luminance signal, a comb filter is necessary. The comb filter is formed by delaying the video by one horizontal line in a glass delay line, and adding this to the undelayed video to produce the luminance component. The chroma cancels because of the 180° phase shift between successive lines of chroma signals. Likewise, subtracting the delayed signal from the undelayed signal produces chroma; while the luminance information, which tends to be the same on successive lines, cancels. Since available glass delay lines have bandwidths of only one or two octaves, it is necessary to modulate the video signal onto a carrier so that the information can pass through the delay line. AM modulation of a 5.11-MHz carrier is used, with modulation limited to less than 50% to minimize quadrature distortions. The lower chroma sideband is 3.58 MHz, derived as the difference frequency between the 5.11-MHz carrier and the 1.53-MHz chroma subcarrier of the original recorded video signal. Therefore, by subtracting the delay line output from the input and filtering with a 3.58-MHz bandpass filter, essentially NTSC chroma can be obtained.

The delay line output is also demodulated with a full-wave envelope detector, producing baseband delayed video. This delayed video is added to the undelayed video to produce a combined luminance signal, which then passes through a short (700 ns) distributed delay line (τ_2) to compensate for the delay of the 3.58-MHz chroma filter.

When the luminance signal is comb filtered, which requires the addition of successive lines, horizontal edges in the picture will be poorly defined because one line will have a luminance value that is the average

of the preceding and succeeding lines. To correct for this loss of resolution in the vertical direction, a vertical detail signal is extracted by subtracting the 1H delayed video signal from the undelayed signal. This signal contains the line-to-line difference information, which is removed by combing. It is then low-pass filtered to remove the chroma information and added back to the combed luminance signal, which makes the vertical picture resolution the same as it was before combing. The only net loss in resolution results on diagonals. This vertical detail signal is added to the combed luminance signal resulting in a composite luminance signal, which is then de-emphasized to remove the pre-emphasis applied during the disc recording process. A keyed clamp is used to set the sync at a constant reference level, after which the 3.58-MHz chroma is added to produce a composite NTSC waveform.

The baseband delayed video is also used to provide defect compensation. This signal is delayed by an additional 325 ns in τ_1 . This corresponds to a 180° phase shift of the 1.53-MHz chroma, so that the resulting chroma phase is the same as the undelayed signal from the video FM demodulator.

5.5 Time-Base Correction System

Due to unavoidable mechanical tolerances in the disc playback system, such as imperfect centering and warp of the disc, the signal recovered from the disc may have significant time-base errors. For example, a centering error of about 7 mils (0.18 mm) would cause a 50 μ sec peak-to-peak error varying at a once-around rate. This causes two problems—poor color reproduction and horizontal sync instability, since errors of this size and rate will not normally be corrected by the color or horizontal locking circuits of a TV receiver due to bandwidth limitation in these circuits. A shift of a few degrees in the 1.53-MHz chroma can cause objectionable variations in hue. Therefore these chroma phase errors must be reduced at least 70 dB. The horizontal sync instabilities can cause objectionable motion of the picture, but these tend to be tracked to some extent by the receiver, and 20 to 30 dB correction is sufficient.

Time-base error correction is accomplished by two closed-loop correction systems driven from the same error signal. The first is the arm-stretcher transducer system, which eliminates much of the error by moving the stylus along the groove in a fashion that maintains substantially constant relative velocity between the stylus and the recorded information on the disc. The second operates to provide the final 3.58-MHz color subcarrier with the stability and accuracy required to assure accurate rendition of color. To do this a phase-locked loop is used

in the following fashion: The buried subcarrier burst signal from the disc at 1.53 MHz nominal is mixed with 5.11 MHz from a local variable frequency oscillator to generate a burst having a nominal frequency of 3.58 MHz as a beat frequency component. This nominal 3.58 MHz component is then compared with an accurate 3.58 MHz carrier from a crystal oscillator. The error signal representing the difference between the two is applied to a variable oscillator with a nominal frequency of 5.11 MHz in such phase as to minimize the difference and attain the required accuracy. The loop is designed with a bandwidth of about 3 kHz, which is approximately 20 times as wide as that permitted in color TV receivers, so it can follow and correct fairly rapid variations in the carrier frequencies from the disc. The correction factor is 50 dB at the disc once-around rate of 7.5 Hz.

The error signal is also passed through an active filter that limits the bandwidth of the time-base correcting arm-stretcher system to 200 Hz, and partially compensates for the resonance of the electromechanical transducer. Since the back-and-forth motion of the transducer cannot correct average speed errors, the very-low-frequency portion of the error signal is extracted with a low-pass filter and added to the 5.11-MHz oscillator control voltage. This causes any average speed error to be tracked by the oscillator rather than the transducer, and effectively limits the response of the mechanical system to rates above 2 Hz.

The closed-loop resonance for the time-base correction system is shown in Figs. 8 and 9. These curves are the time-base error transfer characteristics of the player, i.e., the magnitude of the time-base error at the output for a fixed sinusoidal error at the input, as a function of the

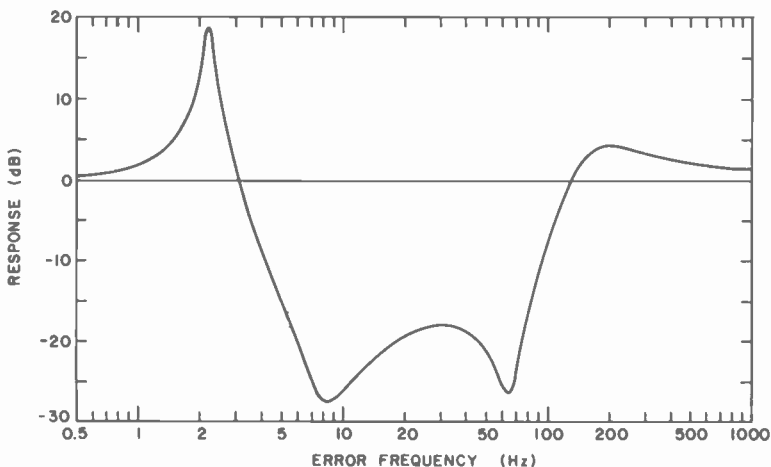

Fig. 8—Armstretcher system, time-base error transfer characteristic.

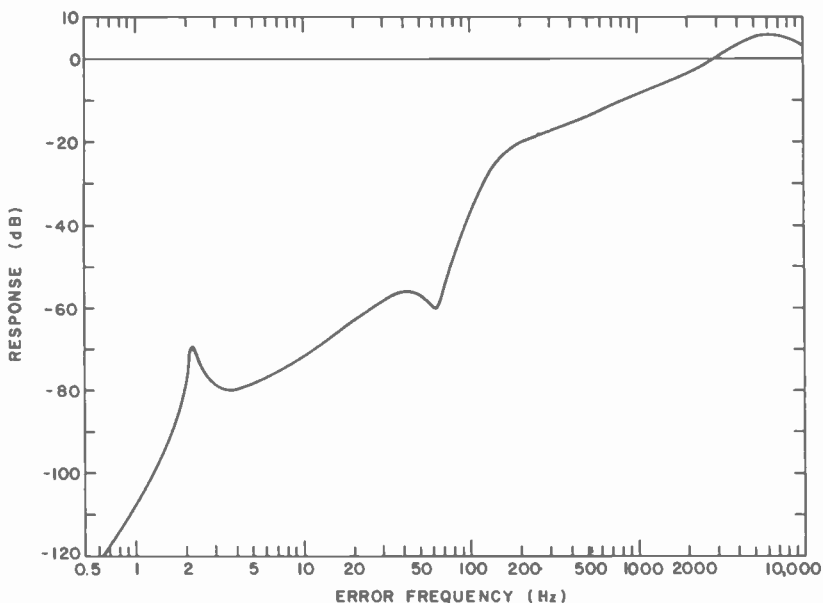

Fig. 9—Chroma phase-error transfer characteristic.

frequency of the disturbance. Fig. 8 shows the response of the electro-mechanical system; all portions of the disc signal (including the audio) are corrected by this system. The largest error component is due to lack of perfect centering of the disc, and results in a 7.5-Hz sinusoidal disturbance. The player was designed to provide maximum correction near this frequency. The correction peak near 65 Hz is due to the mechanical resonance of the transducer. An accentuation of errors occurs near 2.2 Hz, due to limited phase margin on the low-frequency side of the system, but since no significant time-base errors occur at this rate it presents no problem. Fig. 9 shows the transfer characteristics for chroma phase errors. This response results from the sum of the correction provided by the chroma phase-locked loop and the electromechanical system. Below 2 Hz the effect of adding in the dc error from the electromechanical system can be seen.

5.6 RF Modulator

For the player to be used with a standard television receiver, the video and audio signals must be modulated onto a carrier corresponding to a standard television signal. The rf modulator portion of the player performs this function. A choice of either channel 2 or channel 3 is provided to the user by means of a rear-panel switch. A VHF oscillator provides

the appropriate carrier frequency. The audio sum signal from the channel A audio demodulator drives a 4.5-MHz voltage-controlled oscillator, producing the standard 4.5 MHz frequency modulated television sound carrier. This is added to the composite NTSC video signal, and the combination is fed to a ring modulator that modulates the VHF carrier. A filter removes harmonics and the lower sound sideband, and the signal is routed via an antenna switch to the television receiver whenever the player is on. The antenna switch is electrically operated and automatically connects an external antenna to the receiver whenever the disc player is turned off.

5.7 Line Sync

As was described earlier in this paper, the synchronizer locks the turntable to the ac line frequency, so that exactly one revolution of the disc occurs for every eight cycles of line frequency. Since there are exactly four frames, or eight fields, of information per revolution; the field rate of the detected video is 60 Hz, rather than the 59.94 Hz normal to NTSC color broadcast. This also leads to a horizontal line frequency of 15750 Hz instead of the 15734 Hz NTSC color standard. Since these are the same as the nominal frequencies for monochrome transmissions, all receivers operate with no problem. However, receivers use crystal references to extract the chroma reference, so the disc chroma is translated by the player to the NTSC standard of 3.579545 MHz. Although this results in noninterlaced chroma, television receivers normally incorporate 3.58-MHz traps in the luminance channel, so that no serious problems result.

Studies of variations that can occur in the power-line frequencies in the continental U.S. show that the frequency can be closely modeled as a Gaussian random variable having a mean of 60.00 Hz and standard deviation, σ , of approximately 0.006 Hz, or 0.01%. The player is designed to operate over a range of $\pm 0.1\%$, or $\pm 10\sigma$, so that the chance of the power-line frequency variations causing problems is extremely remote.

Power-line frequency is not controlled to this accuracy in most of the rest of the world, including Japan and Europe. The advantage of the synchronizer approach, however, is that it can be independently driven from a stable oscillator of relatively low power to provide constant turntable speed even though the main drive motor driven from the power lines may experience a greater speed variation. The resilient drive belt provides sufficient decoupling of the turntable from the pulley of the drive motor to permit this type of speed correction. The synchronizer can be adapted to 50-MHz operation simply by changing the number

of "poles" magnetized into the ring of magnetic material beneath the turntable.

6. Stylus

Physically the stylus is composed of a stylus tip or substrate with a thin metallic electrode on its flat trailing edge, as shown in Fig. 10. In simple terms the desirable characteristics of the stylus are as follows:

(1) The stylus should track smoothly in the groove maintaining the bottom of the electrode in contact with the signal elements in the groove. If perturbed by large dust particles or disc defects, it should return quickly to tracking without tending to skip to either side of the proper groove.

(2) The stylus should last for at least 200 playing hours without noticeable degradation of its pickup performance. The stylus should be durable and highly resistant to chipping and breakage. Discs played with the styli should exhibit no loss of performance due to wear in at least 50 plays.

(3) The stylus should be capable of playing through the small quantities of dust that, despite the caddy, may appear on disc surface without mistracking or lifting of the electrode away from the signal elements.

(4) The signal generated by the stylus should be capable of producing a stable picture on normal television receivers when discs are played having reasonable tolerances on flatness, centering, etc.

(5) The stylus should be manufacturable at low cost and with high yield.

The design parameters that can be manipulated to achieve these characteristics are (1) stylus material, (2) electrode, (3) tip geometry, (4) arm dynamics, (5) arm-stretcher response, and (6) fabrication and assembly techniques. While it is beyond the scope of this paper to treat these design parameters in detail, certain general statements about them can be made.

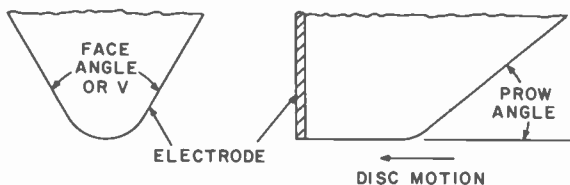

Fig. 10—Tip of stylus.

1. Stylus Material

Although the tracking force is low, approximately 70 milligrams, the small shoe area produces a pressure on the shoe of the stylus in contact with the disc of the order of 10^7 kg/m² so that great strength is required. Sapphire and diamond, in proper crystallographic orientation, have been found to perform satisfactorily. Essentially defect free material for sapphire styli has been grown in long thin rods. Sapphire styli shaped from this material were extensively used in earlier tests. Diamond has a higher cost and is harder to shape than sapphire. Despite this, its wear life and much greater resistance to breakage make it the material of choice. Crystal axes are numerous in diamond and care must be taken to use the best orientations.

2. Electrode

Optimum electrode thickness is determined primarily by the shortest wavelength on the disc and the amount of E-field spreading that occurs in the stylus substrate due to its dielectric constant. At present the electrode is sputtered titanium and it is deposited 1500 Å thick on sapphire and 2500 Å on diamond. Chipping or flaking of the electrode, or of the substrate near the tip of the electrode, can reduce its sensitivity, resulting in a reduction in signal pickup. The player is designed with excess gain and noise figure so that it is tolerant of some signal loss. It is not until more than two-thirds of the bottom of the electrode loses contact with the disc that signal degradation becomes significantly apparent. Good adhesion of the electrode and undamaged substrate are absolute requirements if the electrode is to stand up under the stresses of fabrication and play. This is accomplished by use of great care in cleaning and handling the substrate, and by use of a closed automated sputtering chamber.

3. Tip Geometry

The shaping of the tip starts with the lapping of side facets so that the view from the electrode side is V-shaped. The point of the V is then lapped off to form a shoe. Styli in this form have performed reasonably well but are subject to annoying design compromises. In the limit, if the shoe is too narrow, it will tend to cut into the disc. If it is too wide life will be short, since end of life occurs when the width of the shoe extends beyond that of a single groove (approximately 2.66 μm). The situation can be optimized by varying the angle of the V. As the angle is made more acute, wear life increases but the tendency towards breakage also increases. Broadening the V strengthens the tip, but reduces life. A means for avoiding these compromises was developed in which a keel-shaped

protrusion is lapped into the bottom of the V as shown in Fig. 11. Since the keel has relatively straight sides, its width will not grow with wear. Therefore its initial width can be made almost equal to that of the signal elements in the groove. With this geometry, life is primarily a function of how high the keel can be made before it becomes fragile. These basic geometric considerations strongly favor the keel over the V.

Length of keel or shoe is another parameter that affects both life and breakage. Here the limitation is lift-off of the electrode when playing a warped disc as the shoe becomes too long. Dimensions such as those shown in Fig. 11 perform satisfactorily. The remaining key dimension is the "prow" angle. This is the angle that the leading edge of the stylus makes with the disc as it diverges from the shoe. Its principal effect is on tip strength and/or the separation loss due to debris. In crude description, if the angle is steep the tip may become fragile. In addition, while some fine debris is pushed out of the way, some tends to wrap around the tip lifting it off. If the angle is shallow, the tip becomes stronger and critical wrap-around is reduced but the tip will not push as much debris out of the way and will tend to lift up to ride over it causing loss of signal pick-up. It has been found that a prow angle of around 30° represents a good compromise.

4. Arm Dynamics

Arm dynamics affect the ability of the stylus to track properly in the groove. The basic tracking problem in VideoDisc is quite similar to that encountered in audio players. The tracking forces are applied vertically primarily by means of the spring metal flylead that connects to the tip on the stylus support arm (see Fig. 12). The force remains vertical as long as the stylus remains in the bottom of the groove. Under ideal conditions, the vertical force required approaches zero. However, if there is a per-

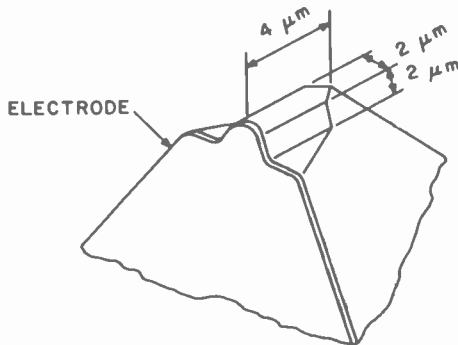

Fig. 11—Tip of keel lapped stylus.

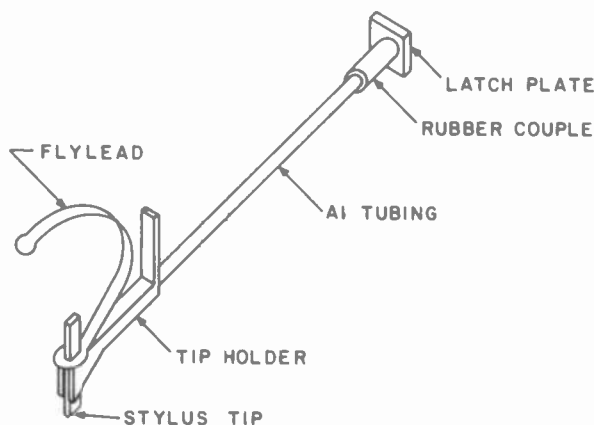

Fig. 12—Stylus support arm.

turbation in the horizontal direction, a restoring force is required, and it is obtained principally from the horizontal component of the tracking force that develops as the stylus tries to move up the groove wall. High tracking forces provide high restoring forces but tend to cause increasing disc and stylus wear. A force of 70 milligrams has been found to be a good design value. In addition, it is important that when the stylus is set down on the disc there is no side force or bias on it. For if there is, it will tend to be relieved during play causing a discontinuity in the picture when the stylus jumps to a new groove.

Problems with tracking become increasingly complex as the speed of the perturbations in both the horizontal and vertical directions increases. Ideally, what is desired is a well damped, very-low-mass system in which the tracking force is obtained by means of a compliant element such as a spring. The design of the cartridge attempts to approach this goal by using very-light-weight materials, resulting in a ratio of spring force to mass of approximately 5 to 1.

Another key aspect of arm dynamics is spring rate, which represents the amount of force required to move the arm a specified distance. In order to minimize the effects of side bias caused by either improper set-down or disc run-out, the horizontal component should be as low as possible. Similarly, to maintain constant tracking force regardless of disc warp, the vertical spring rate should be low. In the present designs the spring rates in both horizontal and vertical directions are around one milligram per mil in the unusual units commonly used by pickup designers.

The final parameter in arm dynamics is damping. In the present design, the stylus support arm is made of thin aluminum tubing, so that

it tends to have relatively high Q . To eliminate possible vibrations, the rear end of the support arm is attached to a rear coupler made of a specially compounded butyl rubber that provides a proper mechanical termination and damps the arm.

5. Arm-Stretcher Response

The structure of the arm-stretcher transducer and its associated drive and loop response were described earlier in this paper. The stylus arm structure is a dominant component in that loop response, and its design is strongly influenced by the needs of the loop. The principal problem is to obtain adequate phase margin for closed-loop stability, so that delay times must be minimized and resonances eliminated or at least heavily damped. As has been noted, the rear coupler provides much of the damping. In addition it is designed to have a very low horizontal and vertical spring rate so that any slight distortions it might suffer in fabrication or with life will not affect the neutral position of the stylus tip. However, since the coupler must convey the arm-stretcher motion to the stylus tip with minimum delay, it is designed to be very stiff in the longitudinal direction. The wide-band open-loop response of the arm stretcher alone (Fig. 13, curve a) can be compared to that of the stylus tip at the end of the arm stretcher (Figure 13, curve b). As can be seen, curve b is quite smooth out to 1500 Hz, which assures the maintenance of good phase margin. The low-frequency peak is the resonance of the transducer at 65 Hz. This is in the high control range, see Figure 8, but is adequately damped by the circuit constants.

The need for smooth response almost certainly requires that the stylus

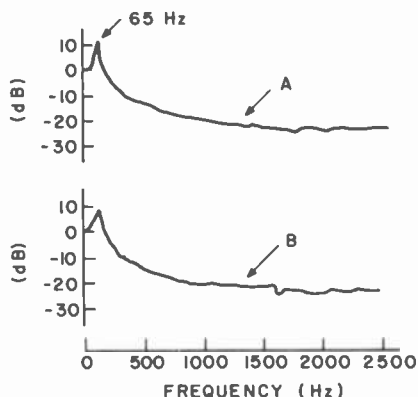

Fig. 13—Open-loop transfer curves of (a) arm stretcher transducer alone and (b) stylus tip on stylus support arm attached to transducer.

support arm be straight, because any bends produce undesirable resonances. This requirement causes a design compromise. If the rear of the straight stylus support arm is attached at a point that is above the surface of the disc, any vertical warp of the disc is converted into fore and aft motion of the stylus tip. These motions add to the burden of the time-base-correction loop. The situation is optimized by placing the rear of the stylus support arm as close to the disc as possible while still maintaining sufficient clearance to permit the playing of warped discs.

7. Summary

It has been shown that the RCA VideoDisc approach based on the use of capacitance pickup of signals from grooved conductive discs permits the design of a player that is simple, reliable, and low in cost. The function of the mechanisms for extraction of discs from the protective caddy and its reinsertion at the end of play have been described, along with descriptions of the manner in which the turntable and stylus arm carriage are driven. The mechanical simplicity of this design and its freedom from critical tolerances and adjustments have been stressed. Design considerations pertaining to signal detection, signal processing, time-base correction, and reconstruction of rf signals for the television receiver have been presented.

Finally, certain considerations relative to the construction and performance of the stylus and arm have been given. It should be recognized that a particular engineering model, the SDT-200W, was chosen to serve as a basis for this discussion of the player and its characteristics. Subsequent models, already in various phases of implementation have benefitted from insights gained in the course of this and earlier designs, and exhibit considerable further simplification and cost reduction.

Acknowledgment

At the risk of overstating the obvious, it must be quite clear that the material covered in this paper represents a long-time effort by a substantial number of people. As is almost always the case, it is not possible to acknowledge their efforts individually. However, the leadership and work by A. J. Bisti, C. D. Boltz, T. J. Christopher, M. E. Miller, F. R. Stave, and W. E. Winston was so outstanding as to warrant special mention, with additional appreciation to Messrs. Christopher, Miller, and Stave for their part in preparing major portions of this material.

Patents Issued to RCA Inventors Fourth Quarter 1977

October

- A. A. Ahmed Current Scaling apparatus 4055774
R. A. Bartolini and A. Bloom Organic Medium for Thin-Phase Holography 4055423
J. C. Bleazey and M. A. Leedom Stylus Arm Lifting/Lowering Apparatus for a Video Disc Player 4053161
W. J. Burke and P. Sheng Recording a Phase Hologram Having Reduced Intermodulation Distortion 4054358
W. J. Derenbecher, Jr. PAL Four-Frame Subcarrier Phase Detector 4052733
M. Glogolja and C. B. Leuthauser Transient and Thermal Protection 4054845
D. E. Griesemer Cathode-Ray Tube Screening Exposure Method 4052725
W. E. Ham Silicon-on-Sapphire Mesa Transistor Having Doped Edges 4054895
L. A. Harwood and E. J. Wittmann Automatic Chrominance Gain Control System 4054905
W. F. Heagerty and L. Dillon, Jr. Edgeless Transistor 4054894
G. B. Herzog Combined Controlled Oscillator and Frequency Multiplier 4052673
R. J. Himics, D. L. Ross, and S. O. Graham Photosensitive Copolymer on Silicon Support 4054454
E. Jellinek Heading Sensor for Vehicle Dead Reckoning System 4055750
H. F. Lockwood and M. Ettenberg Liquid Phase Epitaxial Growth with Interfacial Temperature Difference 4052252
M. J. Lurie Providing a Representation of Information Stored in a Hologram 4054357
G. H. Olsen and V. S. Ban Methods of Defining Regions of Crystalline Material of the Group III-V Compounds 4053350
A. Rosen and L. S. Napoli Microwave Frequency Discriminator Comprising an FET Amplifier 4053841
B. D. Rosenthal Current Subtractor 4055812
W. L. Ross Multi-Target Tracker for Tracking Near Co-Range Targets 4052721
P. J. Schmalz Helical Resonator 4052684
A. V. Tuma and J. Schless Frequency Doubler 4052626
Z. Turski and D. D. Mawhinney Microwave Frequency Discriminator Comprising an FET Amplifier 4053842
P. K. Weimer Charge Transfer Readout Circuits 4055836
C. E. Weltzel Method of Etching Sapphire Utilizing Sulfur Hexafluoride 4052251
C. F. Wheatley, Jr. Transistor Amplifiers 4055811
B. F. Williams, D. L. Staebler, W. J. Burke, and W. Phillips Crystals for Recording Phase Holograms 4052119

November

- A. A. Ahmed Reference Potential Generators 4058760
A. A. Ahmed Semiconductor Circuits for Generating Reference Potentials with Predictable Temperature Coefficients 4059793
E. L. Allen, Jr., and H. Kawamoto Bias Circuit for Avalanche Diodes 4058776
A. L. Baker Sync Responsive Systems for Video Disc Players 4057826
R. R. Brooks Light Flasher Circuit Including GTO 4058751
D. E. Carlson and C. E. Tracy Deposition of Transparent Amorphous Carbon Films 4060660
C. A. Clark, Jr. CRT Display with Truncated Rho-Theta Presentation 4059785
B. Crowle Over-Current Prevention Circuitry for Transistor Amplifiers 4058775
B. DeStephanis Stylus Arm Lifting/Lowering Apparatus for a Video Disc Player System 4059277
R. D. Faulkner Phototube Having Domed Mesh with Non-Uniform Apertures 4060747
P. Foides Antenna System with Automatic Depolarization Correction 4060808
J. B. Halter Wideband Electromechanical Recording System 4060831
D. D. Harbert and R. G. Ferrie Received Signal Selecting System with Priority Control 4057761
N. Hovagimyan and J. M. Link Elastic Buffer for Serial Data 4056851
H. Khajezadeh and S. C. Ahrens Controllably Valued Resistor 4057894
K. Knop Simplified and Improved Diffractive Subtractive Color Filtering Technique 4057326
A. L. Limberg Current Sensing Circuit 4057743
A. F. Marcantonio Priority Vector Interrupt System 4056847
J. I. Nubani and W. R. Rysz Method of Assembling a Mask-Panel Assembly of a Shadow-Mask Cathode-Ray Tube 4058875

L. S. Onyshkevych Transducer Arrangement for a Surface Acoustic Wave Device to Inhibit the Generation of Multiple Reflection Signals 4060833
 W. Phillips Light Modulation Employing Single Crystal Optical Waveguides of Niobium-Doped Lithium Tantalate 4056304
 H. L. Pinch and H. I. Moss Composite Sputtering Method 4060471
 J. J. Risko Sheet Metal Waveguide Horn Antenna 4058813
 T. F. Rosenkranz and R. J. Himics Photoresist Containing a Thiodipropionate Compound 4059449
 O. H. Schade, Jr. Differential Amplifier 4060770
 R. W. Smith and A. R. Moore Method of Filling Apertures with Crystalline Material 4059707
 F. M. Sohn Color Picture Tube Having Mask-Frame Assembly with Reduced Thickness 4056755
 J. L. Vossen, Jr. Method of Depositing Low Stress Hafnium Thin Films 4056457
 C. F. Wheatley, Jr. Current Amplifiers 4057763
 W. M. Woods P+ Silicon Integrated Circuit Interconnection Lines 4057824

December

A. A. Ahmed Voltage Standard Based on Semiconductor Junction Offset Potentials 4061959
 A. F. Arnold Method of Making Gold-Cobalt Contact for Silicon Devices 4065588
 V. S. Ban and S. L. Gilbert Apparatus for Chemical Vapor Deposition 4062318
 B. W. Beyers, Jr. Voltage Storage Circuit Useful in Television Receiver Control Applications 4065681
 W. A. Borgese Apparatus for Measuring a Dimension of an Object 4063820
 D. E. Carlson Semiconductor Device Having a Body of Amorphous Silicon 4064521
 J. M. Cartwright, Jr. Current Mirror Amplifiers with Programmable Current Gains 4064506
 E. L. Crosby, Jr. Apparatus and Method for Measuring Permeability 4064740
 B. Crowle Current Regulating Circuits 4063149
 A. G. Dingwall Integrated Circuit Device Including Both N-Channel and P-Channel Insulated Gate Field Effect Transistors 4063274
 M. T. Gale Black-and-white Diffractive Subtractive Light Filter 4062628
 A. Goldman and P. Datta Method for Making Etch-Resistant Stencil with Dichromate-Sensitized Casein Coating 4061529
 K. H. Gooen Semiconductor Thyristor Devices Having Breakover Protection 4063277
 D. D. Harbert and G. R. Kamerer Signal Quality Evaluator 4063033
 R. H. Hughes Cathode Support Structure for Color Picture Tube Guns to Equalize Cutoff Relation During Warm-up 4063128
 A. J. Leidich Amplifier Circuit 4064463
 D. D. Mawhinney Injection-Locked Voltage Controlled Oscillators 4063188
 K. Miyatani and I. Sato Water Photolysis Apparatus 4061555
 L. Muhlfelder and G. E. Schmidt, Jr. Closed Loop Roll/Yaw Control System for Satellites 4062509
 J. M. Neilson Gate Turn Off Semiconductor Rectifiers 4062032
 L. W. Nero and R. E. Fernsler Horizontal Deflection Circuit with Timing Correction 4063133
 L. L. Oursler, Jr. Radio Frequency Pulse Width Amplitude Modulation System 4063199
 P. T. Patterson System and Method for Authenticating an Electronically Transmitted Document 4064389
 D. L. Ross and L. A. Barton Electron Beam Recording Media Containing 4,4-Bis(3-Diazo-3,4-Dihydro-4-Oxo-1-Naphthalene-Sulfonyloxy)Benzil 4065306
 E. S. Sabisky and C. H. Anderson Gaussmeter 4063158
 D. M. Schneider and L. J. Bazin Constant Pulse Width Sync Regenerator 4064541
 H. G. Seer, Jr. Apparatus for Automatic Color Balancing of Color Television Signals 4064529
 H. A. Stern, H. C. Schindler, and H. Sorkin Method of Filling Dynamic Scattering Liquid Crystal Devices 4064919
 R. G. Stewart Current Mirror Amplifier Augmentation of Regulator Transistor Current Flow 4061962
 R. G. Stewart Memory Cell and Array 4063225
 W. C. Stewart VideoDisc Playback System 4065786
 E. M. Sutphin, Jr. Testing Compression in Engines from Starter Motor Current Waveform 4062232
 A. Waksberg Retro-Reflection Communication System 4064434
 O. M. Woodward and M. S. Stukola Low Cost Linear/Circularly Polarized Antenna 4062019
 C. T. Wu Multiply-Divide Unit 4065666

AUTHORS



Jon K. Clemens received a B.A. degree in Physics from Goshen College in June, 1960, a B.S. and M.S. degree in Electrical Engineering from MIT in June, 1963, and a Ph.D. degree in Electrical Engineering from MIT in September, 1965. His Ph.D. thesis research was in optical character recognition for reading machines for the blind. He joined RCA Laboratories in 1965 to work on consumer video disc systems. The first phase of this work was the study and evaluation of various video disc systems which led him to the invention of the capacitive VideoDisc System. Later aspects of this work included defining the signal system for the VideoDisc and setting the signal and performance related parameters of the complete system.

Dr. Clemens was appointed Head of the Signal Systems Research Group in 1975. He has received three RCA Laboratories Outstanding Achievement Awards and is a member of the IEEE, Eta Kappa Nu, Sigma Xi, and Tau Beta Pi Societies.



Leonard P. Fox received B.S. and M.S. degrees in Chemical Engineering from Lehigh University in 1948 and 1949, respectively. He also received an M.S. degree in Physics from Franklin and Marshall College in 1956. Mr. Fox has been an RCA employee since 1949 and worked at RCA facilities in Lancaster, Pa., and Somerville, N. J. He was Manager, Printed Circuit Manufacturing Engineering, for the RCA Government and Commercial Systems organization in Moorestown, N. J., before joining the Technical Staff of RCA Laboratories in 1970. At the present time, he is Head of Applied Process Research, and is responsible for a group doing research in "SelectaVision" VideoDisc processing. In addition to a team engineering award from the RCA Solid State Division in Somerville, Mr. Fox has received an RCA Laboratories Outstanding Achievement Award in 1970 for "a team effort in devising and improving the processing of storage media for high density recording."

Mr. Fox is a member of the American Chemical Society, the Electrochemical Society, the International Society for Hybrid Microelectronics, Phi Eta Sigma, and Sigma Pi Sigma. He is listed in *Who's Who in Electronics*, *Who's Who in the East*, and *American Men and Women in Science*.



W. J. Gordon is a graduate of Pittsburgh Technical Institute. He joined RCA in 1953 and has held various positions in Manufacturing, engineering, materials engineering, and finance with Consumer Electronics. He has been Manager, SelectaVision VideoDisc Manufacturing, since July 1975. He is responsible for manufacturing, manufacturing engineering, and quality control for the VideoDisc program at Indianapolis.



Istvan Gorog received the B.Sc. (1961), M.Sc. (1962), and Ph.D. (1964) degrees in Electrical Engineering from the University of California at Berkeley. In 1964, Dr. Gorog joined the technical staff of the RCA Laboratories, Princeton, N. J., where his main areas of interest have been quantum electronics and electro-optical systems. His research activities have included lasers and laser systems, holography, pre-recorded-video recording and playback techniques, displays, and investigation of the psycho-physical aspects of electronic imaging. His current activities include product and process development related to the RCA Vid-

eoDisc, manufacturing instrumentation, and electrochromics. Dr. Gorog is Head of the Optical Electronics Research Group at RCA Laboratories.

During 1968 he was on leave of absence from RCA as a National Science Foundation Post-Doctoral Fellow at the Laboratori Nazionali di Frascati and the European Space Research Institute in Frascati, Italy, where he worked on the problems of production of high-temperature plasmas by laser irradiation of solid targets and scattering of laser radiation by collective plasma fluctuations.

Dr. Gorog is a member of the American Physical Society and of Eta Kappa Nu.



William C. Hittinger graduated from Lehigh University in 1944 with a B.S. degree in Metallurgical Engineering. He was awarded the Doctor of Engineering degree by Lehigh in 1974. Following service in World War II, Mr. Hittinger joined Western Electric Company in 1946 as a Materials Engineer. After two years with the National Union Radio Corporation, where he served as Production Manager of its Semiconductor Division, he joined Bell Telephone Laboratories as a member of its technical staff. In 1959, he was named Director of its Semiconductor Device Laboratory and in 1962 became Executive Director of its Semiconductor

Device and Electron Tube Division. In 1966, he was elected President of Bellcomm, Inc., a company jointly owned by American Telephone and Telegraph Company and Western Electric Company which was engaged in systems engineering for NASA's manned spaceflight program. Mr. Hittinger held the post of President of General Instrument Corporation from 1968 to 1970, at which time he joined RCA as Vice President and General Manager of the Solid State Division. After becoming Executive Vice President in 1972, he also assumed responsibility for RCA Consumer Electronics. In 1974, Mr. Hittinger was given the additional responsibility of RCA Electronic Components, an organization that was subsequently realigned into various product divisions. He was elected to the RCA Board of Directors in September 1974.

Mr. Hittinger was appointed Executive Vice President, Research and Engineering for the RCA Corporation on April 26, 1976. In this post, he has direct responsibility for the research and engineering activities in RCA, including the RCA Patent Operations and Laboratories in Princeton, N. J. He is a Director of American Fletcher Corporation and American Fletcher National Bank. He is also a Fellow of the IEEE, a Trustee of Lehigh University, and a Member of the National Academy of Engineering.



Eugene O. Keizer received a B.S. degree in electrical engineering from Iowa State University in 1940 and has been associated with RCA since that time. From 1941 to 1946, he was principally concerned with the development of radar. In 1946, he became engaged in research on FM and television receivers, and in 1951 he received an RCA Achievement Award for his work on receiver circuits. In 1954, he became leader of a receiver and circuit applications research group at RCA Laboratories; was appointed Head, Television Research in 1964; became Head, Video Systems Research in 1967; and in 1977 became Head, Micro Topo-

graphical Research. Mr. Keizer received a David Sarnoff Award in 1976 for his work on color television.

He is a senior member of the IEEE, a member of Eta Kappa Nu, Phi Beta Phi, Tau Beta Pi, Sigma Xi, the American Association for the Advancement of Science, and the New York Academy of Sciences.



Donald S. McCoy received the B.E., M.Eng., and Ph.D. degrees in electrical engineering from Yale University, New Haven, Ct. in 1952, 1954, and 1957, respectively. He served as a member of the faculty of the Electrical Engineering Department at Yale from 1955 to 1957. After joining RCA Corporation at the David Sarnoff Research Center in Princeton, N. J. he was engaged in research in a wide variety of areas including magnetic video tape recording, stereophonic disc recording, psychoacoustical testing, stereophonic broadcast systems, seismic detection systems, and colorimetry of color TV systems. He received RCA Laboratories

Outstanding Achievement Awards in 1960, 1961, and 1964 for his work in acoustics and seismic detection. From 1969 to 1973 he was Director of Consumer Electronics Research at RCA Laboratories. In 1973 he went to Indianapolis as Staff Vice President, SelectaVision VideoDisc Engineering and Manufacturing, with responsibility for establishment of manufacturing facilities and capability for both VideoDiscs and VideoDisc players. He is currently Staff Vice President, VideoDisc Research and Development at RCA Laboratories. Dr. McCoy is a member of IEEE, Tau Beta Pi, and Sigma Xi. He served as technical coordinator for this special issue of the RCA Review.



Roland N. Rhodes received the BEE from CCNY in 1944. He joined the RCA Laboratories in 1948 and has been involved with many aspects of electronic consumer products since the early days of color television. In that field he was active in the research and development of broadcast studio equipment and receiver systems and circuits. This was followed by research and development on display systems, stereophonic AM broadcast systems, and the application of transistors to TV receivers. After transferring to Consumer Electronics in 1961, he managed advanced development whose programs included receiver circuitry, ceramic

hybrid technology, and display systems as well as work on new product possibilities such as homefax, video tape recorders, color cameras, and home computers. During recent years he managed the development of players for the VideoDisc system. Mr. Rhodes has received three David Sarnoff Achievement awards.



Daniel Ross received his Bachelor's degree in chemistry in 1955 from Swarthmore College. In June of 1959 he was awarded the Ph.D. in organic chemistry from the Massachusetts Institute of Technology. His graduate research dealt with the mechanism of elimination reactions of various aliphatic amine derivatives. In 1959, Dr. Ross joined the Research Division of the Polaroid Corporation where he was active in the synthesis of a wide variety of photographically active compounds, azo dyes, and aromatic compounds. In January 1964 he joined the Materials Research Laboratory at RCA Laboratories where he worked on organic laser materials

and investigations of the chemistry of organic derivatives of the rare-earth metals. This work resulted in the discovery of a means to increase the efficiency of europium chelate lasers by nearly 50% through the use of an isotope effect. Dr. Ross has directed and coordinated work on the interaction of laser radiation with organic materials for the RCA Graphic Systems Applied Research Laboratory, and on the exposure of photosensitive materials to cathode ray tube illumination. In 1968 he received an RCA Achievement Award for his work on photochromic materials.

Dr. Ross is presently Head, Organic Materials and Devices Research. In this position he has been responsible for investigations of novel materials and processes for electron-beam recording, liquid-crystal display research, photoresist materials and processes for kinescope fabrication, organic materials for high-resolution information recording, polymer chemistry, investigations of the flammability and toxicity of materials involved in television receiver manufacture, and basic studies of the interaction of organic materials with electro-magnetic fields and radiation. In addition to these responsibilities, during 1976-77, Dr. Ross led a task force of over 50 research scientists and production engineers in the development and implementation of a complex set of coatings for video discs.

Dr. Ross is a member of the Chemical Society (London), The Society of the Sigma Xi, and The American Association for the Advancement of Science, and is listed in American Men and Women of Science.



Robert J. Ryan received the B.A. degree in 1952 from LaSalle College of Philadelphia, and the M.S. degree in Chemistry from Drexel University in 1963. In 1952 Mr. Ryan joined the Electric Storage Battery Company, Philadelphia, and in 1956 was promoted to supervisor-in-charge of the nickel cadmium battery design and development group. Mr. Ryan joined RCA Semiconductor and Materials Division in 1957 and contributed to the investigation of N-Halogen organic compounds for use as cathode materials in reserve batteries. He has engaged in the development of new primary dry and high-rate reserve batteries and the investigation of new anode-cathode materials for primary and secondary batteries. Mr. Ryan received the RCA Engineering Achievement Award in 1963 in recognition of his efforts in developing an electrochemical system for use in missile applications. In 1964, he joined the RCA Laboratories Process Research and Development Laboratory, where he was engaged in the development of interconnection processes for electronic components and subsystems. Mr. Ryan received Laboratories' Achievement Awards in 1965 and 1969 for development of additive multilayer printed-circuit-fabrication processes and materials. He was instrumental in the development of processes and materials for a holographic recording and replication system and was the recipient of the David Sarnoff Medal as part of the Team Award in Science for 1972. In 1972, he set up a plastics processing laboratory and was engaged in research studies relating to the formulation and molding of VideoDiscs. Mr. Ryan joined the SelectaVision Division of RCA in Indianapolis, In., in 1976 as Manager of VideoDisc Development Engineering and is currently responsible for material and processes development for disc replication.

Mr. Ryan is a member of the American Chemical Society, Sigma Chi, and the Society of Plastics Engineers and is listed in *American Men of Science*.



Richard W. Sonnenfeldt graduated cum laude from Johns Hopkins University in 1949 and immediately pursued graduate studies in electronics. Following service in World War II, Mr. Sonnenfeldt was assigned to the Office of Strategic Services and was later Chief Interpreter at the Nuremberg Trials. He began his business career with RCA, Camden, N. J. in 1949 where he rose from student engineer to Manager of Engineering and Production of RCA's Industrial Computer Systems Department. Beginning in 1962 and the following three years, Mr. Sonnenfeldt was General Manager of Computer Systems Division of the Foxboro Co. In 1965, he was elected President and Chief Executive Officer of Digitronics Corporation, during which time he also served the company as Chairman of the Executive Committee and as a member of its Board of Directors. He rejoined RCA in August 1970 as Staff Vice President, New Business Programs. On December 18, 1974, he was appointed Staff Vice President SelectaVision VideoDisc Operations. In this post, Mr. Sonnenfeldt assumed responsibility for the development of the Company's VideoDisc system, including marketing and programming development.

He is a fellow of IEEE and a senior member of the Instrument Society of America and is also a member of Tau Beta Pi and Omicron Delta Kappa honorary fraternities.